

Design of Multivariable PID Controllers: A Comparative Study

Shabeena Memon[†] and Arbab Nighat Kalhoro[†]

shabeenaaslam098@gmail.com and arbab.nighat@faculty.muuet.edu.pk

[†]Department of Electronic Engineering, Mehran University of Engineering and Technology, Jamshoro, Pakistan.

Summary

The Proportional Integral Derivative (PID) controller is the most popular industrial controller and more than 90% process industries use this controller. During the past 50 years, numerous good tuning methods have been proposed for Single Input Single Output Systems. However, design of PI/PID controllers for multivariable processes is a challenge for the researchers. A comparative study of three PID controllers design methods has been carried-out. These methods include the DS (Direct Synthesis) method, IMC (Internal model Control) method and ETF (Effective Transfer Function) method. MIMO PID controllers are designed for a number of 2×2, 3×3 and 4×4 process models with multiple delays. The performance of the three methods has been evaluated through simulation studies in Matlab/Simulink environment. After extensive simulation studies, it is found that the Effective Transfer Function (ETF) Method produces better output responses among two methods. In this work, only decentralized methods of PID controllers have been studied and investigated.

Key words: Direct Synthesis, Internal Model Control, Effective Transfer Function, MIMO Controller, relative gain array, multivariable processes.

1. Introduction

Many of the processes used in industries are multi-input and multi-output (MIMO) processes [1]. In order to get desired performance for such processes is very complex and challenging because in MIMO processes interactions may exist that may affect the output performance of system. Many practicing engineers are quite familiar with Single Input Single Output (SISO) tuning methods but they find difficulty in designing Multiple Input Multiple Output (MIMO) controllers. In multivariable environment, a well optimized PID controller for one loop may degrade the performance of the other loop(s) due to interaction among the loops. Due to this reason, not only well defined procedure is required for finding the unknown PID parameters but proper interaction analysis has to be performed before tuning of the controller.

The Proportional Integral Derivative (PID) has been found in many industrial applications and is most widely used controller in industries [2]. Tuning of controller is important to achieve the optimum response of system. Many tuning techniques are available in literature for SISO systems. However for MIMO systems, design techniques are not well established researchers are working on tuning

and designing of multivariable controllers. When designing PID controller for multivariable system it is important to take in consideration the process interactions between various loops. Figure 1 shows the 2x2 multivariable systems with controller design.

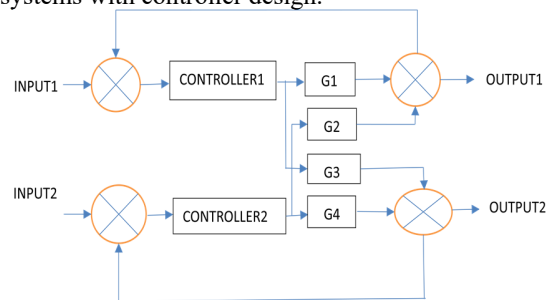

Fig. 1 Block Diagram of MIMO System with Controllers

Following the introduction paper arrangement is described below: Section 2 elaborate the Multivariable and Multi Loop Control system. Section 3 presents the interaction Analysis technique. Detailed explanation of three selected Methods of Decentralized PID Controller is presented in section 4. Section 5 carries out the performance evaluation of the system through simulation studies. The paper concludes with section 6.

2. Multivariable and Multiloop Control System

Generally, the terms *Multivariable* and *Multiloop* control are used interchangeably. However, there is a difference. In multivariable system, each manipulated variable may depend on two or more control variables. On the other hand, in multiloop control system, each manipulated variable may depend on only a single controlled variable. This research is mainly concerned with the multiloop control systems.

For simplicity, assume a Two Input Two Output (TITO) system of Figure 2. Let R_1 and R_2 be the inputs and C_1 , C_2 be the outputs. The plant transfer matrix G of the system is a 2×2 matrix given by [3]

$$G = \begin{bmatrix} G_{11} & G_{12} \\ G_{21} & G_{22} \end{bmatrix}$$
. G_{c1} and G_{c2} are the controllers of the upper and lower loop respectively.

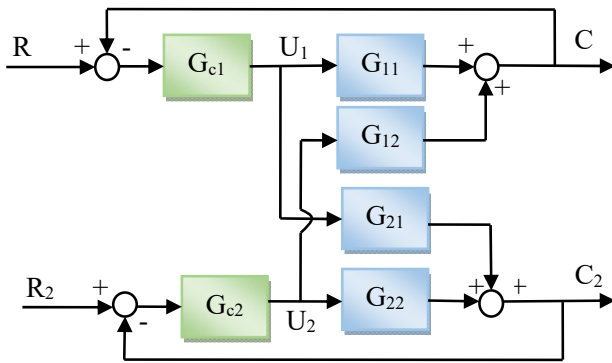

Fig. 2 Two input Two Output System

The controller G_{c1} can be tuned to control the upper loop but its output through G_{21} may degrade the performance of the lower loop. Similarly, the controller G_{c2} can control C_2 but it may be harmful for C_1 because of its output through G_{12} . The interaction from loop1 to loop2 via G_{21} and the same from loop2 to loop 1 via G_{12} make multivariable control very difficult and challenging for the researchers. Multivariable controllers are to be designed in such a way that they produce satisfactory outputs and minimize the process interactions. The problem of interactions becomes more difficult when there are more number of inputs and outputs.

3. Interaction Analysis Using Relative Gain Array

The Relative Gain Array was first introduced by Bristol in 1966 [4]. This array gives us best input-output pairing. It is also used as a measure of process interactions. Only steady state information is required for the computation of the RGA. It is defined as follows:

$$\lambda_{ij} = \frac{\left(\frac{\partial c_i}{\partial u_j}\right)_{u_{k,k \neq j}}}{\left(\frac{\partial c_i}{\partial u_j}\right)_{c_{k,k \neq i}}} \tag{1}$$

For higher dimension processes, the RGA matrix can be computed as follows:

$$RGA = G(0) \otimes (G(0))^{-T} \tag{2}$$

Where \otimes denotes the Schur product.

Following MATLAB code can be used to compute the RGA of any process transfer function G:

G0 = dcgain(G)

Gi = pinv(G);

RGA = G.*Gi'

In the above code, pinv is the pseudo inverse which is suitable to find inverse of a square as well as non-square matrix.

4. Methods of Decentralized PID Controller

Following three methods have been selected for comparison. They have been chosen for our usefulness, easy tuning and popularity among process engineers.

4.1 The Direct Synthesis (DS) Method

Direct synthesis (DS) method is model based technique that is comprised of a process model and a closed-loop transfer function [5]. We may design PI or PID controller using DS method for common process models. In order to get the response that closely matches the desired response the controller is designed using mathematical calculations. Specification of closed loop transfer function may define the performance characteristics therefore we may get optimum output response using this technique. In order to derive transfer function for following closed loop system let us assume the basic block diagram shown below in Figure 3.

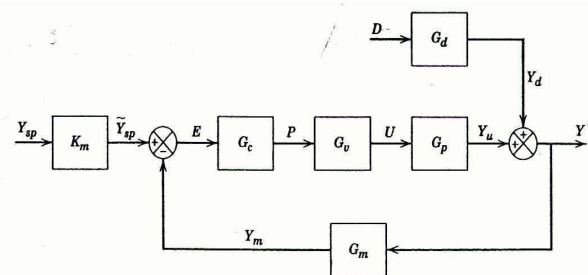

Fig. 3 Block diagram for Direct Synthesis Method

$$\frac{Y}{Y_{sp}} = \frac{K_m G_c G_v G_p}{1 + G_c G_v G_p G_m} \tag{3}$$

Let us assume $G \triangleq G_p G_m G_m$ and suppose that $G_m = K_m$ then equation (3) becomes as follows:

$$\frac{Y}{Y_{sp}} = \frac{G_c G}{1 + G_c G} \tag{4}$$

Altering the equation (4) and solving for G_c expression may be represented as

$$G_c = \frac{1}{G} \left(\frac{\frac{Y}{Y_{sp}}}{1 - \frac{Y}{Y_{sp}}} \right) \tag{5}$$

In order to arrange the equation for practical design approach expression can be derived as follows

$$G_c = \frac{1}{G} \left(\frac{\left(\frac{Y}{Y_{sp}}\right)_d}{1 - \left(\frac{Y}{Y_{sp}}\right)_d} \right) \tag{6}$$

4.2 Internal Model Control Method

Internal Model Control (IMC) is a more extensive model-based design technique. It was introduced by Morari [6] and coworkers [7]. The design consists of a process model and a controller designed using IMC method that leads to

analytical expression for controller settings. The simplified block diagram for IMC method design shown in Figure 4. It comprise of a process model \tilde{G} and the output of controller represented as P. The difference between Actual response and model response $Y - \tilde{Y}$ acts as the input to the controller G_c^* .

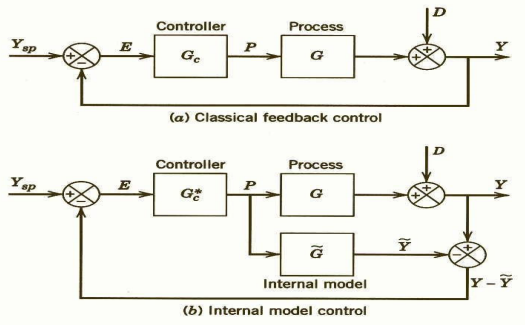

Fig. 4 Basic Block diagram of Internal Model Controller

The design procedure for IMC controller consist of following two steps

Step1: The model is factored and given by $G = \tilde{G}_+ \tilde{G}_-$ (7)

Where \tilde{G}_+ carries any time delay and Zeros at right half plane. In order to ensure these two factors are identical it is used for steady state gain equal to 1.

Step2: The controller is represented by $G_c^* = \frac{1}{\tilde{G}_-} f$ (8)

Where f specifies a low pass filter with a steady state gain of one. This is given as

$$f = \frac{1}{(\tau_c + 1)^r} \tag{9}$$

4.3 Effective Transfer Function Method

This is the third method which has been chosen for design of PID controllers. This method proposed by Xiang [8] uses the ERGA tool to decide the best pairing. The detailed description of the method can be found in Wang [9]. Here only main steps are reproduced.

Step1: Find the RGA and ERGA of the given process model. RGA should have the following form:

$$RGA = \begin{bmatrix} \lambda_{11} & \lambda_{12} & \dots & \lambda_{1n} \\ \lambda_{21} & \lambda_{22} & \dots & \lambda_{2n} \\ \dots & \dots & \dots & \dots \\ \lambda_{n1} & \lambda_{n2} & \dots & \lambda_{nn} \end{bmatrix} \tag{10}$$

And ERGA may be represented as

$$ERGA = \begin{bmatrix} \phi_{11} & \phi_{12} & \dots & \phi_{1n} \\ \phi_{21} & \phi_{22} & \dots & \phi_{2n} \\ \dots & \dots & \dots & \dots \\ \phi_{n1} & \phi_{n2} & \dots & \phi_{nn} \end{bmatrix} \tag{11}$$

From (10) and (11), define the Relative Frequency Array (RFA) by performing Hadamard division of ERGA by RGA. That is,

$$RFA = \begin{bmatrix} \gamma_{11} & \gamma_{12} & \dots & \gamma_{1n} \\ \gamma_{21} & \gamma_{22} & \dots & \gamma_{2n} \\ \dots & \dots & \dots & \dots \\ \gamma_{n1} & \gamma_{n2} & \dots & \gamma_{nn} \end{bmatrix} \tag{12}$$

Where

$$\gamma_{ij} = \frac{\phi_{ij}}{\lambda_{ij}} \tag{13}$$

Step 2: Assume that each main loop is represented by a SOPTD model of the following form:

$$g_{ii}(s) = \frac{b_{0,ii}}{a_{2,ii}s^2 + a_{1,ii}s + 1} e^{-\tau_{ii}s} \tag{14}$$

The corresponding Effective Transfer Function (ETF) is represented as

$$g_{e,ii}(s) = \frac{g_{e,ii}}{a_{2,ii}s^2 + a_{1,ii}s + 1} e^{-d_{ii}s} \tag{15}$$

Now, use Table 1 to compute the PID parameters. This method assumes the following form of diagonal PID controllers:

$$U(s) = K_{p,ii} e(t) + K_{i,ii} \int_0^t e(\tau) d\tau + K_{d,ii} \frac{de(t)}{dt} \tag{16}$$

The PID parameters in Table 1 have been computed based on Gain Margin (A_m) and Phase Margin (F_m) specifications.

Case	$g_{e,ii}$	$K_{p,ii}$	$K_{i,ii}$	$K_{d,ii}$
$\lambda_{ii} \leq 1, \gamma_{ii} \leq 1$	$\frac{g_{ii}(0)/\lambda_{ii}}{a_{2,ii}s^2 + a_{1,ii}s + 1} e^{-\tau_{ii}s}$	$\frac{\pi \lambda_{ii} a_{1,ii}}{2A_m \tau_{ii} g_{ii}(0)}$	$\frac{\pi \lambda_{ii}}{2A_m \tau_{ii} g_{ii}(0)}$	$\frac{\pi \lambda_{ii} a_{2,ii}}{2A_m \tau_{ii} g_{ii}(0)}$
$\lambda_{ii} \leq 1, \gamma_{ii} > 1$	$\frac{g_{ii}(0)/\lambda_{ii}}{a_{2,ii}s^2 + a_{1,ii}s + 1} e^{-\gamma_{ii} \tau_{ii} s}$	$\frac{\pi \lambda_{ii} a_{1,ii}}{2A_m \gamma_{ii} \tau_{ii} g_{ii}(0)}$	$\frac{\pi \lambda_{ii}}{2A_m \gamma_{ii} \tau_{ii} g_{ii}(0)}$	$\frac{\pi \lambda_{ii} a_{2,ii}}{2A_m \gamma_{ii} \tau_{ii} g_{ii}(0)}$
$\lambda_{ii} > 1, \gamma_{ii} \leq 1$	$\frac{g_{ii}(0)}{a_{2,ii}s^2 + a_{1,ii}s + 1} e^{-\tau_{ii}s}$	$\frac{\pi a_{1,ii}}{2A_m \tau_{ii} g_{ii}(0)}$	$\frac{\pi}{2A_m \tau_{ii} g_{ii}(0)}$	$\frac{\pi a_{2,ii}}{2A_m \tau_{ii} g_{ii}(0)}$

$\lambda_{ii}>1, \gamma_{ii}>1$	$\frac{g_{ii}(0)}{a_{2,ii}s^2 + a_{1,ii}s + 1} e^{-\gamma_{ii}\tau_{ii}s}$	$\frac{\pi a_{1,ii}}{2A_m \gamma_{ii} \tau_{ii} g_{ii}(0)}$	$\frac{\pi}{2A_m \gamma_{ii} \tau_{ii} g_{ii}(0)}$	$\frac{\pi a_{2,ii}}{2A_m \gamma_{ii} \tau_{ii} g_{ii}(0)}$
---------------------------------	--	---	--	---

Table 1: PID controller parameters of Wang et al method.

5. Results and Discussion

This section presents the results and comparative study of PID controller design. A benchmark of 2x2, 3x3 and 4x4 process models have been chosen from the literature. For each model, PI/PID controller parameters have been computed by using the following three methods:

- DS Method
- IMC Method
- ETF Method

Matlab/Simulink has been used as simulation tool.

5.1 Two Input Two Output Models

In this part, structural issues and pairing configurations of three 2x2 process models are investigated and PI/PID controllers are designed by using the above mentioned three methods.

5.1.1 Wood and Berry (WB) Model

Wood and Berry is a very famous model among process engineers. This TITO model was introduced by Wood and Berry [10] and it is used to separate methanol from water. Under normal condition, products are taken away and new feed is appended to the distillation column however, the process is disturbed due to change is feed, ambient temperature or condensing etc. In order to get a complete detachment of products the term Reflux is used that is defined as the portion of the condensed liquid product from a column/tower which goes back to the original part. Wood and Berry [1973] derived following transfer matrix of the system:

$$\begin{bmatrix} X_D(s) \\ X_B(s) \end{bmatrix} = \begin{bmatrix} 12.8e^{-s} & -18.9e^{-3s} \\ 16.7s+1 & 21s+1 \\ 6.6e^{-7s} & -19.4e^{-3s} \\ 10.9s+1 & 14.4s+1 \end{bmatrix} \begin{bmatrix} R(s) \\ S(s) \end{bmatrix} \quad (17)$$

where $X_D(s)$ is the distillate Methanol (mol%) and $X_B(s)$ is water (mol%). The outputs $R(s)$ and $S(s)$ are the reflux flow rate (lb/min) and stream flow rate (lb/min) respectively.

Analysis:

Controller parameters are calculated for all three methods and are given below in Table 2. The system has also been represented as a Simulink model, as shown in Figure 5. The step responses of the two loops are shown in Figure 6. As expected, the effective transfer function (ETF) method gives the best output result as illustrated.

PI Parameters	DS	IMC	ETF
$K_{p,11}$	0.1186	0.2174	0.3889
$K_{i,11}$	0.0071	0.01302	0.02329
$K_{p,22}$	-0.0570	-0.0627	-0.07376
$K_{i,22}$	-0.00396	-0.00644	-0.005122

Table 2: PID settings: DS, IMC and ETF Method

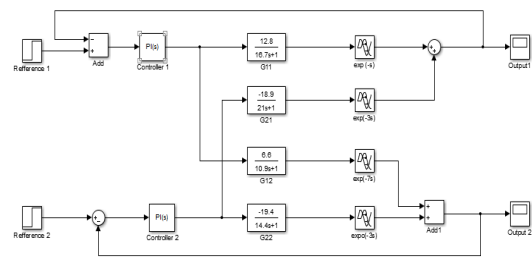

Fig. 5 Simulink representation of TITO system with WB Model

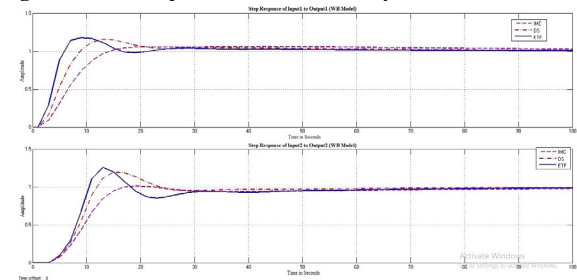

Fig. 6 Step response of WB Model (IMC, DS and ETF)

5.1.2 Vinante and Luyben (VL) Model

This is another famous TITO distillation column model separating methanol from water. The model was derived from a 24-tray distillation column. Vinante and Luyben in 1972 [11] observed that temperatures of 4th and 17th tray are the most important output variables [12]. They studies responses of these two variables with respect to change in reflux flow and stream flow rate and therefore derived the following model:

$$\begin{bmatrix} T_{17}(s) \\ T_4(s) \end{bmatrix} = \begin{bmatrix} -2.2e^{-s} & 1.3e^{-0.3s} \\ 7s+1 & 7s+1 \\ -2.8e^{-1.8s} & 4.3e^{-0.35s} \\ 9.5s+1 & 9.2s+1 \end{bmatrix} \begin{bmatrix} R(s) \\ S(s) \end{bmatrix} \quad (18)$$

where

$T_{17}(s)$ = Temperature ($^{\circ}C$) of tray No. 17

$T_4(s)$ = Temperature ($^{\circ}C$) of tray No. 4

R(s) = Reflux flow rate (kg/h)
 S(s) = Stream flow rate (kg/h)

Analysis:

Calculated controller parameters for VL model are given below in Table

PI Parameter	DS	IMC	ETF
$K_{p,11}$	-0.5302	-0.7953	-1
$K_{i,11}$	-0.0757	-0.1136	-0.1428
$K_{p,22}$	0.4049	0.6386	1.92
$K_{i,22}$	0.0440	0.0694	0.2087

Table 3: PID settings: DS, IMC and ETF Method (VL Model)

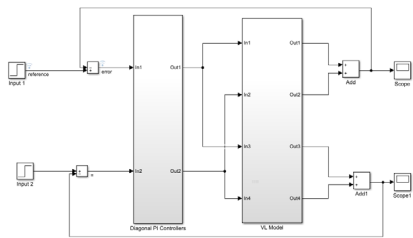

Fig. 7 Simulink setup of VL model with diagonal PI controllers

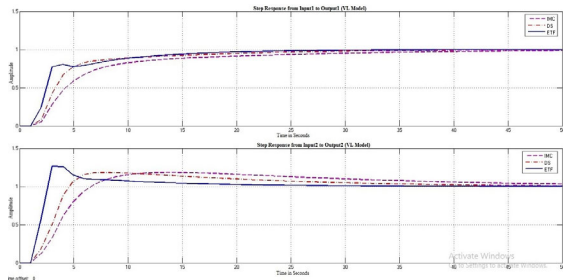

Fig. 8 Step Response of VL Model

5.1.3 The Wardle and Wood (WW) Model

This TITO distillation Column model was proposed by Wardle and Wood [13]. The model is represented in transfer function as below:

$$G(s) = \begin{bmatrix} \frac{0.126e^{-6s}}{60s+1} & \frac{-0.101e^{-12s}}{(48s+1)(45s+1)} \\ \frac{0.094e^{-8s}}{38s+1} & \frac{-0.12e^{-8s}}{35s+1} \end{bmatrix} \quad (19)$$

Analysis:

PI Parameters	DS	IMC	ETF
$K_{p,11}$	18.315	29.7618	24.93
$K_{i,11}$	0.3052	0.496	0.4156
$K_{p,22}$	-10.375	-16.138	-11.45
$K_{i,22}$	-0.296	-0.461	-0.3272

Table 4: PID settings: DS, IMC and ETF Method (WW Model)

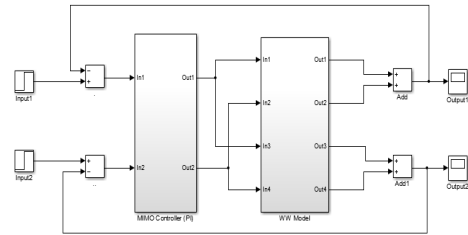

Fig. 9 Simulink setup of WW model with diagonal PI controllers

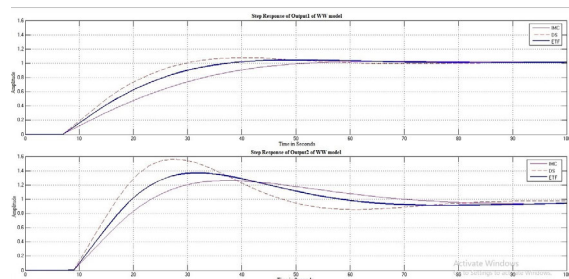

Fig. 10 Step Response of WW Model

5.2 Three Input Three Output Models

After successful design of PI/PID controllers for three TITO models, this research presents results of two process models having three inputs and three outputs.

5.2.1 Ogunnaike and Ray (OR) Model

This is a very famous 3x3 model of a distillation column [14].

The transfer matrix of the model is

$$\begin{bmatrix} \frac{0.66e^{-2.6s}}{6.7s+1} & \frac{-0.61e^{-3.5s}}{8.64s+1} & \frac{-0.0049e^{-5s}}{9.06s+1} \\ \frac{1.11e^{-6.5s}}{3.25s+1} & \frac{-2.36e^{-3s}}{5s+1} & \frac{-0.01e^{-1.2s}}{7.09s+1} \\ \frac{-34.68e^{-9.2s}}{8.15s+1} & \frac{46.2e^{-9.4s}}{10.9s+1} & \frac{0.87(11.61s+1)e^{-5s}}{(3.89s+1)(18.8s+1)} \end{bmatrix} \quad (20)$$

Analysis:

Table 5: PI/PID settings for OR model

PI Parameters	DS	IMC	ETF
$K_{p,11}$	1.0389	1.33568	0.7666
$K_{i,11}$	0.19935	0.19935	0.1144
$K_{d,11}$	0	0	0
$K_{p,22}$	-0.1009	-0.2648	-0.1387
$K_{i,22}$	-0.0529	-0.0529	-0.0277
$K_{d,22}$	0	0	0
$K_{p,33}$	4.3466	4.3466	2.257
$K_{i,33}$	0.1915	0.1915	0.2257
$K_{d,33}$	0	0	0

The Simulink implementation of the closed loop PI/PID controlled OR model is shown in Figure 11.

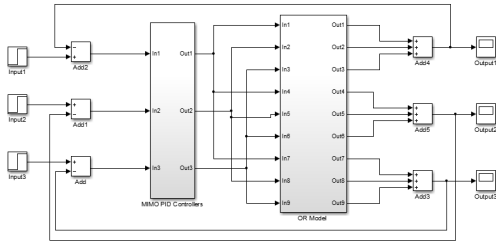

Fig. 11 Simulink implementation of the closed loop OR system

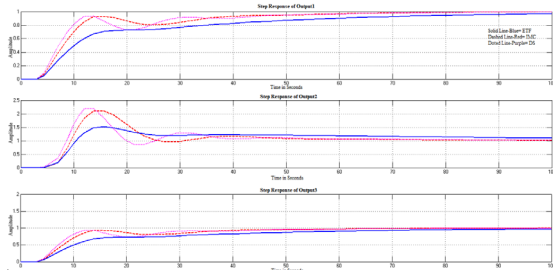

Fig. 12 Step responses of OR model with DS, IMC and ETF method

5.2.2 Tyreus Case 4 (T4) Model

This model has the following transfer matrix [12]:

$$\begin{bmatrix} \frac{-1.986e^{-0.71s}}{66.67s+1} & \frac{5.24e^{-60s}}{400s+1} & \frac{5.984e^{-2.24s}}{14.29s+1} \\ \frac{0.0204e^{-0.59s}}{(7.14s+1)^2} & \frac{-0.33e^{-0.68s}}{(2.38s+1)^2} & \frac{2.38}{(1.43s+1)^2} \\ \frac{0.374e^{-7.65s}}{22.22s+1} & \frac{-11.3e^{-3.79s}}{(22.74s+1)^2} & \frac{-9.811e^{-1.59s}}{11.36s+1} \end{bmatrix} \quad (21)$$

Like previous cases, PI/PID controllers have been tuned (see Table 6) for this model by using the three methods. The resultant output responses are plotted as shown in Figure 14.

Table 6: PID/PD settings for T4 model

PI/PID Parameter	DS	IMC	ETF
$K_{p,11}$	-15.42	-9.284	-25.84
$K_{i,11}$	-2.974	-0.1392	-6.065
$K_{d,11}$	-5.472	0	0
$K_{p,22}$	-0.653	-0.5	-1.817
$K_{i,22}$	-0.101	-0.1748	-0.721
$K_{d,22}$	-0.287	-0.3575	0
$K_{p,33}$	-0.369	-0.1504	-0.5692
$K_{i,33}$	-0.058	-0.0653	-0.2475
$K_{d,33}$	-0.160	0	0

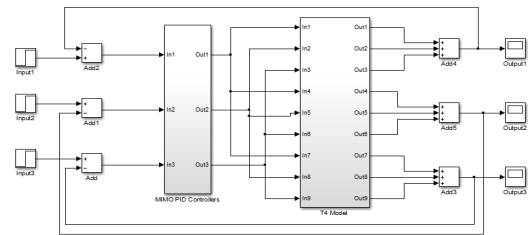

Fig. 13 Simulink implementation of the closed loop T4 system

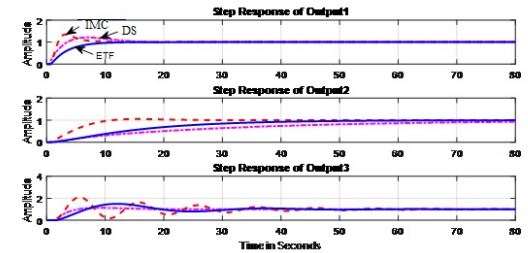

Fig. 14 Step Responses of the three loops of T4 model

5.3 Four Input Four Output (4x4) Models

In this Section, PI/PID controllers are designed for a 4x4 process model

5.3.1 HVAC Model

This centralized Heating, Ventilation and Air Conditioning (HVAC) model of four rooms was derived by Shen [15]. Its transfer matrix is given as follows:

$$\begin{bmatrix} \frac{-0.098e^{-17s}}{122s+1} & \frac{-0.036e^{-27s}}{149s+1} & \frac{-0.014e^{-32s}}{158s+1} & \frac{-0.017e^{-90s}}{155s+1} \\ \frac{-0.043e^{-25s}}{147s+1} & \frac{-0.092e^{-16s}}{130s+1} & \frac{-0.011e^{-33s}}{156s+1} & \frac{-0.012e^{-34s}}{157s+1} \\ \frac{-0.012e^{-31s}}{153s+1} & \frac{-0.016e^{-34s}}{151s+1} & \frac{-0.102e^{-16s}}{118s+1} & \frac{-0.033e^{-26s}}{146s+1} \\ \frac{-0.013e^{-32s}}{156s+1} & \frac{-0.015e^{-31s}}{159s+1} & \frac{-0.029e^{-25s}}{144s+1} & \frac{-0.108e^{-18s}}{128s+1} \end{bmatrix} \quad (22)$$

Analysis:

Table 7: PI/PID settings for HVAC Model

PI/PID Parameters	DS	IMC	ETF
$K_{p,11}$	-33.6456	-46.1069	-25.42
$K_{i,11}$	-0.2757	-0.3779	-0.1706
$K_{d,11}$	0	0	0
$K_{p,22}$	-39.2508	-54.3475	-22.6
$K_{i,22}$	-0.3019	-0.4180	-0.1537
$K_{d,22}$	0	0	0
$K_{p,33}$	-32.135	-44.4946	-22.71
$K_{i,33}$	-0.2723	-0.377	-0.1925
$K_{d,33}$	0	0	0
$K_{p,44}$	-31.1888	-42.3277	-20.69
$K_{i,44}$	-0.2436	-0.3306	-0.1616
$K_{d,44}$	0	0	0

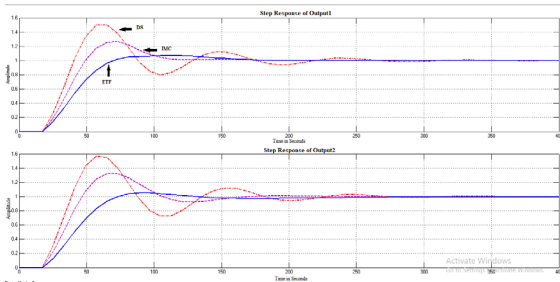

Fig. 15 Step Responses of output 1 and 2 of HVAC Model

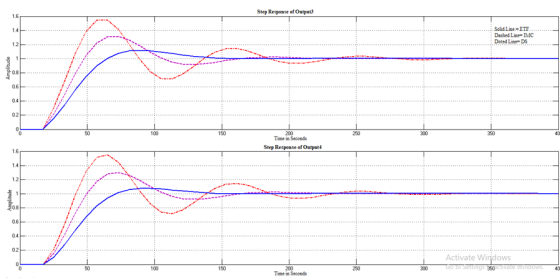

Fig. 16 Step Responses of output 3 and 4 of HVAC Model

6. Conclusion

This research presents comparative analysis of the following three methods of decentralized PI/PID controllers: The DS Method, IMC Method and Effective Transfer Function Methods. The transient behavior of the IMC and Effective Transfer function method is generally better than the DS method. Moreover, both DS and IMC methods are computationally cheaper than the ETF method. A number of benchmark process models have been used for the design of controllers. Comparative analyses have been carried-out through simulation studies. It is observed from obtained results that output responses using the Effective Transfer Function method produce better output results than the other two methods. Therefore, Effective Transfer Function Method is recommended for control of industrial multivariable processes.

References:

- [1] G.Hemanth Krishna ,R.Kiranmayi, and M.Rathaiah, " Control System Design for 3x3 Processes Based on Effective Transfer Function and Fractional Order Filter", *International Journal of Engineering and Advanced Technology*, Volume 8, Issue 6, pp. 637-642, August 2019.
- [2] Shamsuzzoha and Mohd, "A unified approach for proportional-integral-derivative controller design for time delay processes", *Korean Journal of Chemical Engineering*, Volume 32, pp. 583-596, April 2014
- [3] Diaz Rodriguez, Ivan D, Han, Sangjin, and Shankar P. Bhattacharyya, "Analytical Design of PID controllers", *Springer Science and Business Media LLC*, January 2019
- [4] E.Bristol, "On a New Measure of Interactions for Multivariable Process Control", *IEEE Transactions on Automatic Control*, Volume 11, Issue 1, pp. 133-134, January 1966.
- [5] Seborg, Dale E, Duncan A. Mellichamp, Thomas F. Edgar, and Francis J. Doyle III," *Process dynamics and control*", John Wiley & Sons, 2010.
- [6] Garcia C.E and Morari M, "Internal Model Control. A Unifying Review and Some New Results", *Industrial and Engineering Chemistry Process Design and Development*, Volume 21, Issue 2, pp. 308-323, April 1982.
- [7] Rivera, Daniel E, Manfred Morari, and Sigurd Skogestad, "Internal model control: PID controller design", *Industrial & engineering chemistry process design and development*, Volume 25, Issue 1, pp. 252-265, January 1986.
- [8] Xiong Q, Cai W.J and He M.J, "Effective Transfer Function Method for Decentralized Control System Design of Multi-Input Multi-Output processes" , *Journal of Process Control*, Volume 16, Issue 8, pp.773-784, September 2006.
- [9] Wang Q.G, Hang C.C, and Zou B, "Multivariable Process Identification and Control from Decentralized Relay Feedback", *International Journal of Modeling and Simulation*, Volume 20, Issue 4, pp. 341-348, July 2015.
- [10] Wood R.K and Berry M.W, "Terminal composition control of a binary distillation column", *Chemical Engineering Science*, Volume 28, issue 9, pp. 1707–1717, September 1973.
- [11] W. Lubyen and C. Vinante,"Experimental studies of distillation decoupling", *kem. Teollisuus*, Volume 29, pp. 499-514, 1972.
- [12] Luyben W.L, "Simple Method for Tuning SISO Controllers in Multivariable Systems", *Industrial and Engineering Chemistry Process Design and Development*, Volume 25, Issue 3, pp. 654-600, July 1986.
- [13] Wardle, A.P, Wood and R.M, "Problems of Application of Theoretical Feed-forward Control Models to Industrial Scale Fractionating Plants", *Institute of Chemical Engineers (ICHEME) Symposium Series*, Volume 32, pp. 68–81, 1969.
- [14] Ogunnaik B.A and Ray W.H," Multivariable Controller Design for Linear Systems having Multiple Time Delays", *AIChE Journal*, Volume 25, pp. 1043–1060, November 1979.
- [15] Shen Y, Cai W. J, and Li S. ,"Normalized Decoupling Control for High-Dimensional MIMO Processes for Application in Room Temperature Control HVAC Systems", *Control Engineering Practice*, Volume 18, Issue 6, pp. 652–664,2010.