

Analysis of the Emission Benefits of Using Alternative Maritime Power (AMP) for Ships

Kyunghwa Kim* · Gilltae Roh** · Kangwoo Chun***†

*, ** Future Technology Research Team, Korean Register (KR), 36 Myeongji Ocean City 9-ro, Gangseo-gu, Busan, 46762, Republic of Korea

Abstract : The marine industry contributes a large proportion of the air pollutant emissions along coastal regions, and this air pollution has been strongly linked to cardiovascular diseases and other illnesses. To alleviate the problem, many ports have installed alternative maritime power (AMP) facilities that enable onboard marine auxiliary engines with generators (gensets) to be shut down while a ship is at berth. This study compared the emissions from conventional gensets with those from AMP facilities, focusing on four emission types: greenhouse gases (GHG), sulphur oxides (SO_x), nitrogen oxides (NO_x), and particulate matter (PM). Both direct (combustion / operation) and indirect (upstream) emissions were considered together for the emission comparison. The results showed that AMP has lower emissions than conventional onboard gensets, and this benefit is highly dependent on the electricity generation mix onshore. On average, GHG emissions could be reduced by about 18.3 %, while the other emissions (SO_x, NO_x and PM) would decrease more dramatically (88.4 %, 90.1 %, and 91.5 %, respectively). Additionally, future benefits of the AMP would increase due to the expansion of renewable energies. Thus, this study supports the potential of AMP as a promising solution for environmental concerns at ports worldwide.

Key Words : Alternative maritime power (AMP), Shore power, Ship emissions, Electricity generation mix, Emission control area (ECA)

1. Introduction

The world has endeavored to reduce greenhouse gases (GHGs), harmful exhaust gases for human survival. It requires cooperation in all industrial fields and has been given duties in the marine industry as well. To share this responsibility for the protection of the global environment, in April 2018, the International Maritime Organization (IMO) adopted an initial strategy for the reduction of GHG emissions from ships. This initiative aims for a reduction in total GHG emissions from international shipping of at least 50 % by 2050 compared to 2008 (IMO, 2018).

In coastal regions, ships at berth are the main source of shipping emissions because they typically spend one or more days there, depending on the ship type and cargo volume. For example, the average time spent at berth is around 91 hours for a bulk carrier, 33 hours for a container ship, and 54 hours for a crude oil tanker (EPA, 2017). Generally, being at berth accounts for 23.3 % of the entire life cycle of a ship, compared with normal seagoing at 75.2 % and maneuvering at 1.5 % (IMO, 2016).

In most cases, the main engines are turned off when a ship is at berth, but onboard marine auxiliary engines with generators (gensets) are kept in service to provide power for onboard electrical

systems. Some of the electrical requirements while at berth include but are not limited to, lighting, heating, refrigeration, ventilation, and cargo loading / unloading equipment.

Emissions from major ports influence the local air quality and may directly affect the health of nearby residents. For example, emissions from ships at port are estimated to cause 14,500-37,500 premature deaths annually in East Asia, one of the fastest-growing shipping regions (Liu et al., 2016). To reduce the environmental impact of shipping, certain areas have been declared SO_x Emission Control Areas (SECAs). No vessel sailing in a SECA has been allowed to use fuel with a sulphur content of more than 0.1 % since 2015. This concept also applies to NO_x Emission Control Areas (NECAs). Current IMO ECAs are listed below (Clarksons, 2017):

- Baltic Sea (SO_x, May 2006; NO_x, January 2021)
- North Sea (SO_x, November 2007; NO_x, January 2021)
- North American Sea (including Hawaiian) (SO_x, PM, Aug. 2012; NO_x, Jan. 2016)
- US Caribbean Sea (SO_x, PM, Jan. 2014; NO_x, January 2016).

China has also introduced three domestic ECAs (Bohai Sea, Yangtze River Delta, and Pearl River Delta). Ships at berth within the three Chinese ECAs, except for one hour after berthing and one hour before departure, was required to use 0.5 %S fuel (i.e., fuel with a sulfur content ≤ 0.5 % m/m) until the end of 2018.

* First Author : kimkh@krs.co.kr, 070-8799-8759

† Corresponding Author : kwchun@krs.co.kr, 070-8799-8745

Starting on January 1, 2019, ships have been required to burn 0.5%S fuel for their entire time within the three ECAs (Marinelog, 2017). In addition, the Norwegian coastline, the Mediterranean, Japan, South Korea, Hong Kong, Singapore/the Malacca Straits, and South Africa are also under consideration as ECAs (Clarksons, 2018).

To comply with ECA regulations, most ship owners consider three options: after-treatment systems (e.g., scrubbers, selective catalytic reduction), alternative fuels (e.g., LNG, MGO), or alternative maritime power (AMP). AMP, also known as cold ironing, is an onshore power supply facility that provides electricity from a grid to a ship at berth so it does not need to use its onboard gensets. AMP has received significant attentions as a means of reducing harmful emissions and mitigating the associated health concerns at and around ports. Particularly, the AMP installation has been increasing at ports within ECAs. For example, in the United States, AMP facilities with the high voltage (> 6.6 kV) capacity have been installed at 16 ports for large cruise ships, container ships, etc. (ERG and EERA, 2017).

The significant environmental benefits of AMP have been reported. For example, it has been claimed that the AMP could reduce CO₂ emissions by as much as 12.5 million tons annually at ports in Norway alone (Greenport, 2017). Additionally, the United States Environmental Protection Agency (EPA) stated that, under the right circumstances (i.e., depending on the mix of energy sources), overall emissions at ports could be reduced by up to 98% simply by utilizing power from regional electricity grids (ERG and EERA, 2017).

In this regard, several studies have investigated AMP as a promising solution for pollutant emissions at ports. The *White Bay Cruise Terminal* (Starcrest, 2017) and the *Port of Shenzhen* in China (Wang et al., 2015) performed an economic and environmental feasibility analysis for AMP systems. Also, *Han and Lim* (2010) investigated the environmental and monetary impacts of the AMP focusing on 'Saemuri', a training ship. These studies highlighted that AMP is both environmental and cost-beneficial in comparison to other alternatives. In addition, *Vaishnav et al.* (2016) mentioned that the health and environmental benefits of supplying ships with grid electricity could be balanced by the cost of ship and port retrofit.

However, questions have been raised about any environmental impact of AMP that may have been overlooked. For example, a literature review by *Peng* (2016) concluded that using shore power for ships at berth instead of power generated by onboard gensets in China would lead to a minor increase in CO₂ emissions but

would effectively reduce the emissions of other air pollutants such as NO_x, SO_x, and PM.

Following this recent wave of interests in the environmental benefits of AMP, this paper compares and analyzes the emissions from onboard gensets and AMP while at port. Chapter 2 presents the scope and underlying assumptions of this study, while Chapter 3 covers the emissions generated by conventional onboard gensets while at berth. Emissions from AMP are covered in Chapter 4, and Chapter 5 compares the emission results from AMP and conventional gensets, and necessary future studies regarding AMP are addressed. Concluding remarks are provided in Chapter 6.

2. Scope and Assumptions

2.1 Emissions

This study focuses on the environmental effects of conventional onboard gensets and AMP when a ship is at berth. The life-cycle emissions assessments have been conducted in many industries. For example, in the automotive industry, the assessment of life-cycle emissions has two main parts (well-to-tank and tank-to-wheel), tracing emissions from the primary fuel to the end user (i.e., vehicle propulsion). In many studies (Holdway et al., 2010; Peng et al., 2017; Yuksel et al., 2016; Ke et al., 2017; Woo et al., 2017), the indirect emissions for electric vehicles generated when charging from the grid have been investigated, and emission comparisons between electric vehicles and conventional diesel vehicles have been analyzed from a life-cycle perspective. It has been found that electric vehicles can decrease emissions in comparison to those of conventional gasoline and diesel vehicles.

The approach to emission analysis in the marine industry is similar to that in the automotive industry, so this study covers the life-cycle emissions for each fuel. The emissions for each fuel consist of indirect emissions (i.e., upstream processes) and direct emissions (i.e., combustion/operation processes).

Indirect emissions (upstream emissions) are generated from primary fuel (i.e., raw materials) through to the delivery to the ship or power plant before generating electricity. In other words, they include all emissions produced from the primary fuel before direct use by the end-user, such as extraction, transport, refining, purification, and so on (Hill et al., 2017). The pathways for various fuels to the end-user covered in this study are presented in Fig. 1.

The emissions assessed in this study are GHGs and the three harmful pollutants (SO_x, NO_x, and PM). Each emission type except PM is heavily regulated by the IMO.

Analysis of the Emission Benefits of Using Alternative Maritime Power (AMP) for Ships

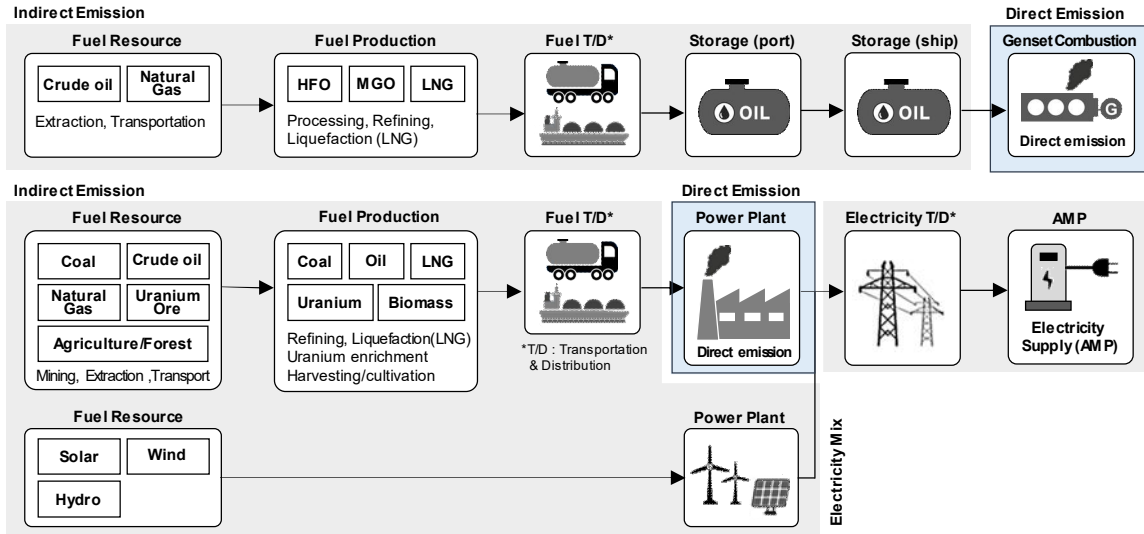

Fig. 1. The fuel life-cycle pathway covered in this study.

2.2 Fuel

It is assumed that conventional onboard gensets are fueled by one of three main fuels. The first one is heavy fuel oil (HFO), which is the most commonly used fuel in the marine industry. The second is marine gas oil (MGO), an apt choice for complying with ECA emission limits (Molly, 2016). The third is liquid natural gas (LNG), the most promising alternative fuel so far.

Eight primary energy sources were selected for AMP: coal, natural gas (NG), nuclear power, oil, hydropower (hydro), wind, solar, and bioenergy. The data for each primary energy source used in this study was derived from various literature reviews or researches. The mix of these primary energy sources used to generate electricity varies significantly by region depending on available resources and regional market prices (EIA, 2013). This study considers regions that have already installed a number of AMP facilities: the European Union, the United States, and China. They have also designated ECAs or are in the process of implementing ECA designations.

2.3 Assumptions

The method for calculating emission factors needs to be adjusted in order to accurately assess emission levels and understand their impact on air quality in harbor cities and coastal regions. As such, this study has to establish some assumptions regarding the emission generation.

First, the specific fuel oil consumption (SFOC) of a genset is not constant over its entire operating range; it varies depending on

its loading factor. In particular, in light load conditions, a genset runs less efficiently, and this leads to a relative increase in emissions compared to normal operating conditions. Therefore, for onboard gensets, emissions vary depending on the load factor (L_f). Also, the efficiency of a genset (η_g) must be considered. The modified emission factor for an onboard genset ($E'_{f,G}$) is shown in Equation (1) based on the general emission factor ($E_{f,G}$):

$$E'_{f,G}(i) = \frac{E_{f,G}(i) \times L_f}{\eta_g} \quad (g/kWh) \quad (1)$$

where i = emission type (CO_2 , SO_x , NO_x , PM)

L_f = correction for the load factor of a genset (%)

η_g = onboard genset efficiency (%).

The load factor of a genset while at berth differs depending on the ship size and type. In this study, it is assumed to be around 50-55% (EPA, 2017; Nicewicz and Tarpanowicz, 2012). Based on this, the L_f is assumed to be 1.03 for CO_2 and SO_x (Kristenen, 2015; MARINE, 2018), and 1.00 for NO_x and PM (MARINE, 2018). These corrections are only applied to direct emissions. Also, η_g is assumed to be 0.96 (MAN, 2018) in this study.

In contrast, emissions from AMP increase when converting grid electricity to onboard electricity. A transformer is installed to match the onboard voltage level, and a frequency converter might be used optionally to match the onboard frequency (50 Hz or 60 Hz) (Fig. 2).

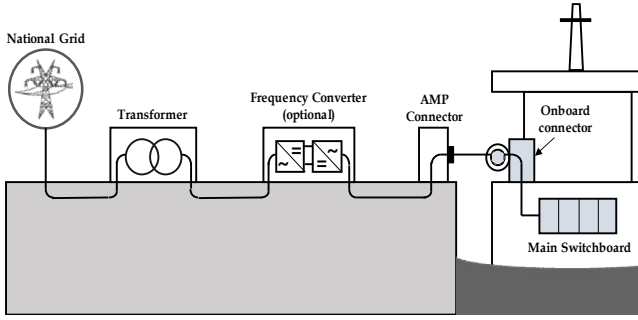

Fig. 2. An overview of the shore-to-ship power connection for AMP.

In this regard, the modified emission factor ($E'_{f,AMP}$) is used to calculate the emissions from AMP based on the general emission factor ($E_{f,AMP}$):

$$E'_{f,AMP}(i) = \frac{E_{f,AMP}(i)}{\eta_c \times \eta_t} \quad (\text{g/kWh}) \quad (2)$$

where i = emission type (CO_2 , SO_x , NO_x , PM)

η_c = frequency converter efficiency (%)

η_t = transformer efficiency (%)

In this study, η_c and η_t are assumed to be 0.98 each (ABB, 2017; Schneider-electric, 2015). For both cases, the total emissions ($E[\text{g}]$) can be calculated by applying the modified emission factor (E'_f [g/kWh]) as below:

$$E(i) = P \times t \times E'_f(i) \quad (3)$$

where P (kW) is the generated electric power from an onboard genset or grid, and t (h) is the operating time in hours.

3. Emissions from Ship Gensets

3.1 GHG emissions

As of January 1, 2013, all newly built ships with a gross tonnage of 400 and above must reduce their CO_2 emissions according to the Energy Efficiency Design Index (EEDI) in three stages (2015, 2020, and 2025). This is an energy efficiency measure applying to ship transportation with the aim of reducing CO_2 emissions from operation activities on ships. In addition, the IMO and the EU have attempted to reduce GHG emissions from ships by collecting and analyzing emission data.

The CO_2 emission factor ($E_{f,G}(\text{CO}_2)$) of a genset is proportional to fuel oil consumption according to the following equation:

$$E_{f,G}(\text{CO}_2) = C_f \times SFOC_G \quad (4)$$

where C_f ($\text{g}\cdot\text{CO}_2/\text{g}\cdot\text{fuel}$) is a non-dimensional conversion factor between fuel consumption and CO_2 emissions, both of which are measured in grams, based on carbon content. $SFOC_G$ ($\text{g}\cdot\text{fuel}/\text{kWh}$) is the specific fuel oil consumption of a genset. The C_f and $SFOC_G$ values used in this study are listed in Table 1. For the $SFOC_G$, the average value is applied using the general four-stroke genset data available from references (Wärtsilä, 2017; MAK, 2015; MARINE, 2017; Rolls-Royce, 2018; Gilbert et al., 2018; IMO, 2015; Rolls-Royce, 2017).

Table 1. The main characteristics of ship fuel and assumed SFOC of a genset

Fuel	Lower calorific value (kJ/kg) ^a	Carbon content ^a	C_f ($\text{g}\cdot\text{CO}_2/\text{g}\cdot\text{fuel}$) ^a	$SFOC_G$ ($\text{g}\cdot\text{fuel}/\text{kWh}$) ^b
HFO	40,200	0.8493	3.114	178.6
MGO	42,700	0.8744	3.206	173.4
LNG	48,000	0.7500	2.750	161.5

^a Source: IMO (2017a).

^b Sources: Wärtsilä (2017); MAK (2015); MARINE (2017); Rolls-Royce (2018); Gilbert et al. (2018); IMO (2015); Rolls-Royce (2017).

The data listed in Table 1 is variable depending on (a) engine type (i.e., main, auxiliary, or auxiliary boilers), (b) engine speed (slow, medium, or high), (c) type of service (duty cycle), (d) fuel type (HFO, MGO, and LNG), and (e) engine load variability (IMO, 2015).

GHG emissions are calculated using the CO_2 -equivalent global warming potential by directly summing the 100-year conversion coefficients recommended by the 5th Assessment Report (AR5) of the Intergovernmental Panel for Climate Change (IPCC) for the three main GHG emission types (CO_2 , CH_4 , and N_2O) (IPCC, 2014). Furthermore, the GHG emission factors are calculated as:

$$E_{f,G}(\text{GHG}) = E_{f,G}(\text{CO}_2) + 28 \times E_{f,G}(\text{CH}_4) + 265 \times E_{f,G}(\text{N}_2\text{O}) \quad (5)$$

In this study, the GHG emission factors for each ship fuel type are shown in Table 2.

Analysis of the Emission Benefits of Using Alternative Maritime Power (AMP) for Ships

Table 2. GHG emission factors of ship fuels.

Fuel	$E_{f,G}(\text{CO}_2)$ (g/kWh)	$E_{f,G}(\text{CH}_4)$ (g/kWh) ^a	$E_{f,G}(\text{N}_2\text{O})$ (g/kWh) ^b	$E_{f,G}(\text{GHG})$ (g/kWh)
HFO	556.16	0.01	2.8610-2	564.96
MGO	555.92	0.01	2.7710-2	564.45
LNG	444.13	5.3	1.810-2	597.89

Note. N_2O (g/kWh) = $0.16 \times \text{SFOC}$ (g-fuel/kWh) / 1,000.

^a Sources: Olmer et al. (2017); Stenersen and Thonstad (2017).

^b Sources: Olmer et al. (2017); IMO (2015).

In Table 2, each CO_2 emission factor is calculated based on Equation (4), and each CH_4 and N_2O emission factor is based on data from references. The CH_4 emission factor of LNG is applied from the average value between lean-burn spark ignited engines (LBSI) and low-pressure dual fuel (LPDF) engines manufactured after 2010 (Stenersen and Thonstad, 2017). Each GHG emission factor is recalculated according to Equation (1), and the results are presented in Table 6.

3.2 SO_x emissions

According to IMO regulations (MARPOL Annex VI), the sulphur content of fuel (%S) should be restricted to reduce SO_x emissions, and this restriction differs by region (Table 3).

Table 3. IMO restrictions of SO_x emissions for ships (diesel engine).

Pollutant	Region	SO_x limit (m/m)	Date
SO_x	Global	4.50 %	Prior to 2012
		3.50 %	Since 2012
		0.50 %	From 2020
	Inside ECA	1.50 %	Prior to 2010
		1.00 %	Since 2010
		0.10 %	Since 2015

The SO_x emission factor ($E_{f,G}[\text{SO}_x]$) of a genset is determined directly from the fuel sulphur content according to Equation (6):

$$E_{f,G}(\text{SO}_x) = \text{SFOC} \times 2 \times 0.97753 \times \%S \quad (6)$$

Equation (6) includes a constant indicating that approximately 98 % of the fuel sulphur will be converted to gaseous SO_2 and that about 2 % of the sulphur can be found in particulate matter (IMO, 2015). The latest report shows that the worldwide average sulphur

content of HFO was 2.58 %, while the worldwide average sulphur content of MGO was 0.08 % in 2016 (IMO, 2017b). This means that the use of HFO is currently not allowed within ECAs, and it will also be restricted globally on and after January 1, 2020. The average values and the restricted values of the SO_x emission factor are presented in Table 4.

The SO_x emission factor for LNG gensets is assumed based on the average value from manufacturers' data, and each SO_x emission factor is recalculated according to Equation (1), and the results displayed in Table 6.

Table 4. The average and restricted values of SO_x emission factors.

Fuel	Average value		Restricted value		
	%S	Emission factor (g/kWh)	%S	Emission factor (g/kWh)	Region
HFO	2.58	9.01	3.50	11.87	Global (until 2019)
MGO	0.08	0.27	0.50	1.70	Global (from 2020)
			0.10	0.34	ECA (since 2015)

3.3 NO_x emissions

According to IMO regulations (MARPOL Annex VI), the NO_x emission restriction consists of three tiers for diesel engines (with a power output of more than 130 kW) depending on the maximum engine operating speed and the year of build (Table 5). All gensets are treated as medium-speed diesel (MSD) engines (called Category 2) with a rated engine speed (RPM) of $130 \leq n < 2000$ (Moreno-Gutiérrez et al., 2012). The applied tier differs depending on whether the ship is operating inside or outside an ECA.

Table 5. IMO restrictions on NO_x emissions for ships (diesel engine).

Pollutant	Type	Region	NO_x limit ^a (g/kWh)	Date (K/L)
NO_x	Tier I	-	$45 \times n^{-0.2}$	Prior to 2011
	Tier II	Global	$44 \times n^{-0.23}$	Since 2011
	Tier III	Inside ECA	$9 \times n^{-0.2}$	Since 2016 (2021 ^b)

^a Limitation for Category 2 (RPM: $130 \leq n < 2000$).

^b Restrictions planned for the Baltic and the North Sea.

In this study, it is assumed that the rotating speed of a 60Hz genset is 720 rpm. For a genset using HFO, its NO_x emissions are assumed to be 93 % of the limit value for Tier II engines

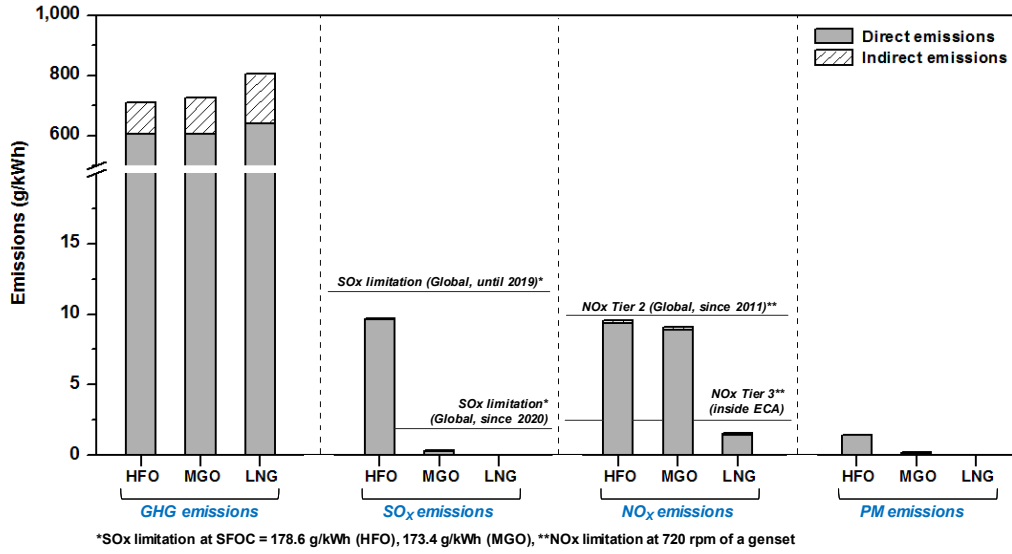

Fig. 3 Emissions from an onboard genset while at berth.

(MARINE, 2018). For a genset using MGO, it is known that it has 5% lower NO_x emissions than an HFO-fuelled genset (Trozzi, 2010). For LNG gensets, NO_x emission factors are based on the average value from manufacturers’ data. Additionally, each NO_x emission factor is recalculated according to Equation (1), and the results displayed in Table 6.

Table 6. Emission factors from an onboard genset while at berth.

Emission type	Fuel	Total emissions factor (g/kWh) ^a	Direct emission rate (%) ^b
GHG	HFO	711.01	85
	MGO	727.47	83
	LNG	804.29	80
SO _x	HFO	9.7253	99
	MGO	0.3507	83
	LNG	0.0036	89
NO _x	HFO	9.5499	98
	MGO	9.0806	98
	LNG	1.5651	91
PM	HFO	1.4485	100
	MGO	0.2013	96
	LNG	0.0266	98

^a Sources: Olmer et al. (2017); IMO (2015); Lopez-Aparicio and Tønnesen (2015); Gilbert et al. (2018); Gilbert et al. (2018); MARINE (2017); IMO (2015); Rolls-Royce (2017); Lopez-Aparicio and Tønnesen (2015); Gilbert et al. (2018); Kristenen (2015); MARINE (2017); IMO (2015).

^b Sources: ThinkStep (2017); Schmied and Knörr (2012); Lowell et al. (2013); APH (2018); Castelazo (2011).

3.4 PM emissions

The IMO does not specifically restrict PM but regulates the sulfate portion of PM through SO_x restrictions (ABS, 2017). PM is associated with sulphur because a certain fraction of oxidized sulphur is emitted as sulphuric acid, which easily condenses to sulphuric acid particles in exhaust gases (MARINE, 2018). Therefore, the PM emission factor ($E_{f,G}(PM)$) of a genset for HFO is calculated as (IMO, 2015):

$$E_{f,G}(PM) = 1.35 + (SFOC \times 7 \times 0.02247 \times (\%S - 0.0246)) \quad (7)$$

The PM emission factor for MGO is calculated as (IMO, 2015):

$$E_{f,G}(PM) = 0.23 + (SFOC \times 7 \times 0.02247 \times (\%S - 0.0024)) \quad (8)$$

For LNG gensets, PM emission factors are calculated based on the average value from manufacturers’ data, and each PM emission factor is recalculated according to Equation (1). The results are presented in Table 6.

Fig. 3 presents a comparison of the emission factors for each fuel based on Table 6. As shown in the table, although LNG has significantly lower SO_x, NO_x, and PM emissions, it has higher GHG emissions than the other fuels. This is caused by the leakage of unburned methane, known as methane slip. Methane leakage during the combustion process accounts for about 24.8% of its total GHG emissions.

In addition, LNG has the highest volume of indirect emissions among the ship fuels. These upstream emissions are related to the

Analysis of the Emission Benefits of Using Alternative Maritime Power (AMP) for Ships

Table 7. Emission factors from AMP while at berth.

Emission type	Electricity source	Emission factor (g/kWh)		
		Total ^a		Direct emission rate ^b (%)
		Average	Min. - Max.	
GHG	Coal	1,026.42	888 - 1205	94
	Natural gas	497.62	218 - 659	77
	Nuclear	29.78	12 - 40	56
	Oil	833.69	733 - 1,180	89
	Hydro	24.40	11 - 37	84
	Wind	17.76	10 - 30	0
	Solar	52.42	18 - 85	0
	Biomass	53.00	39 - 75	30
SO _x	Coal	2.4165	0.4510 - 5.9000	91
	Natural gas	0.0068	0.0066 - 0.0070	16
	Nuclear	0.1347	0.0200 - 0.1920	3
	Oil	2.9273	2.1319 - 4.2500	98
	Hydro	0.0057	0.0004 - 0.0110	0
	Wind	0.0275	0.0250 - 0.0300	0
	Solar	0.0464	0.0327 - 0.0600	0
	Biomass	0.0792	0.0684 - 0.0900	70
NO _x	Coal	1.7607	0.6900 - 2.8300	97
	Natural gas	0.5702	0.3300 - 0.8000	49
	Nuclear	0.0665	0.0400 - 0.0800	3
	Oil	1.3073	0.7200 - 1.7690	86
	Hydro	0.0107	0.0013 - 0.0200	0
	Wind	0.0275	0.0150 - 0.0400	0
	Solar	0.0386	0.0300 - 0.0472	0
	Biomass	0.8636	0.1368 - 1.9440	70
PM	Coal	0.2602	0.0900 - 0.6417	93
	Natural gas	0.0049	0.0027 - 0.0070	23
	Nuclear	0.0042	0.0042 - 0.0042	8
	Oil	0.2367	0.1134 - 0.3600	97
	Hydro	0.0027	0.0001 - 0.0053	0
	Wind	0.0188	0.0095 - 0.0280	0
	Solar	0.0365	0.0030 - 0.0700	0
	Biomass	0.1298	0.0095 - 0.2500	90

^a Sources: CEC (2004); Abrahams et al. (2015); Cai et al. (2012); DEA (2016); FEPC (2014); HATCH (2008); HATCH (2014); CO₂ emissiefactoren (2017); ICF (2013); Khaenson et al. (2017); Kristensen et al. (2004); Krittayakasem et al. (2011); Louwen (2011); Lueken et al. (2016); Moro and Lonza (2017); Khartchenko and Kharchenko (2014); Ozawa et al. (2017); Pant and Olsen (2013); Kuo (2014); Devasahayam et al. (2017); Skone et al. (2013); Skone et al. (2014); Turconi et al. (2013); WNA (2017); Xcel Energy (2018); Peng et al. (2017); Woo et al. (2017); Schmied and Knörr (2012).

^b Sources: Bates and Henry (2009); Castelazo (2011); APH (2018); Abrahams et al. (2015); Louwen (2011); Skone et al. (2013); Skone et al. (2014).

handling, processing, transporting, and bunkering of natural gas (Lowell et al., 2013), and it can be changeable depending on the life-cycle process employed.

4. Emissions by AMP

4.1 Power source

The potential of AMP for reducing global emissions depends on the power source mix used in electricity generation. Different power sources have different emission factors depending on the life-cycle pathway and variable regional characteristics.

For non-renewable power sources, the vast majority of emissions are released during combustion at power plants: 94 % of GHGs for coal, 77 % for NG, and 89 % for oil. On the other hand, nuclear power plants have a relatively lower emission impact because a single nuclear power plant can produce a more significant amount of electricity compared to other power sources. However, other factors need to be considered, such as the risk of explosion, initial investment, and emissions generated during construction or decommission phases, etc.

Renewable energies are highly reliant on local geographical conditions and the level of available technology. Renewable energies produce few direct emissions except for bioenergy; biomass combustion leads to relatively high emissions of NO_x and PM in comparison to other renewable energy sources. Of the various biomass resources, wood pellets/chips are the primary cause of high emissions during combustion operations (AQEG, 2017).

For wind energy, it is not divided into onshore and offshore wind power in this study because each has similar emission factors. Even though offshore wind turbines have a higher productivity in comparison to onshore ones, they generate greater emissions during the construction phase (Turconi et al., 2013).

Table 7 and Figs. 4-7 present emission factors for each of the eight power sources by emission type. This data is based on literature surveys and Equation (2).

4.2 Electricity generation mix

The electricity generation mix can vary widely from country to country as shown in Fig. 8. In other words, emission factors from power generation plants have both site-specific and region-specific influences (WNA, 2017).

Therefore, the emission factor for electricity generation can be calculated below in combination with Equation (2):

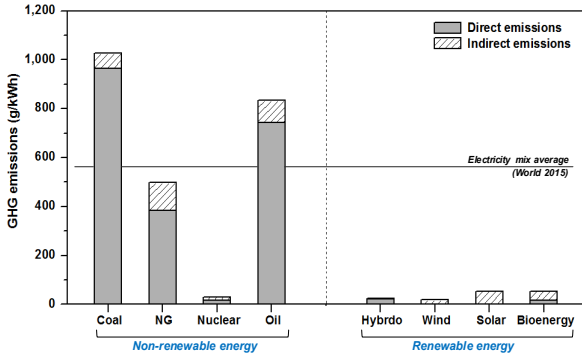

Fig. 4 GHG emissions by different electricity generation sources.

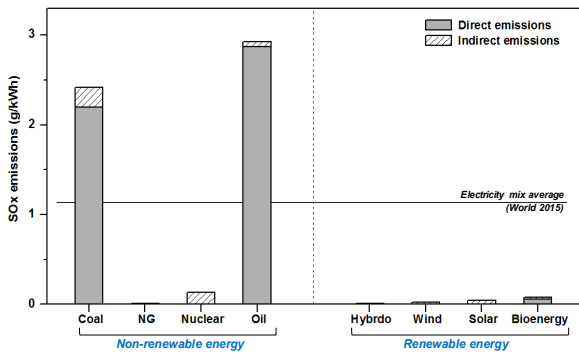

Fig. 5 SO_x emissions by different electricity generation sources.

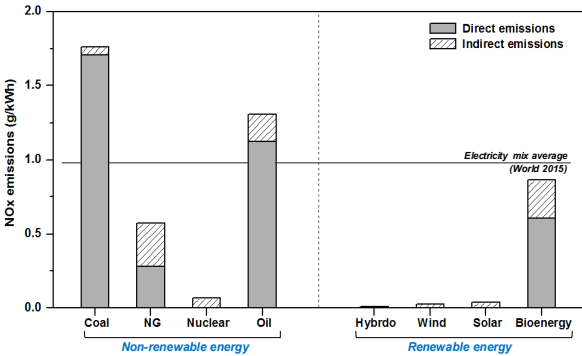

Fig. 6. NO_x emissions by different electricity generation sources.

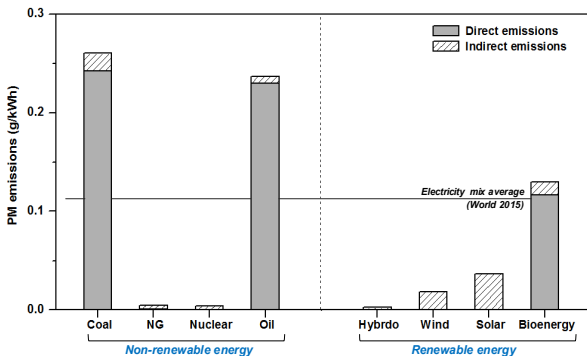

Fig. 7. PM emissions by different electricity generation sources.

$$E'_{f,AMP}(i) = \frac{\sum_e \{E_f(e, i) \times \mu(e, i)\}}{\eta_c \times \eta_t} \quad (9)$$

where i = emission type (GHG, SO_x, NO_x, or PM)
 e = power source for generating electricity
 (coal, natural gas, nuclear, oil, wind, etc.)
 μ = share of the electricity generation mix (%)
 η_c = frequency converter efficiency (%)
 η_t = transformer efficiency (%).

As shown in Fig. 8, EU nations, where many AMP facilities have been installed, have a high share of renewable power sources with 30.0 % on average, due to strong environmental regulations and subsidies. On a global average in 2015, 39 % of electricity came from coal, 23 % from natural gas, 10% from nuclear power, 4 % from oil, and 24 % from renewable energies.

The proportion of electricity generated by non-renewable power sources is expected to drop significantly by 2050, whereas renewable energy is predicted to account for 85 % of electricity generation in 2050. Specifically, solar and wind are expected to lead the way, rising from 800 GW now to 13,000 GW by 2050. It is also expected that no new coal plants will be commissioned and 95 % of coal plants in operation now will be phased out (IRENA, 2018).

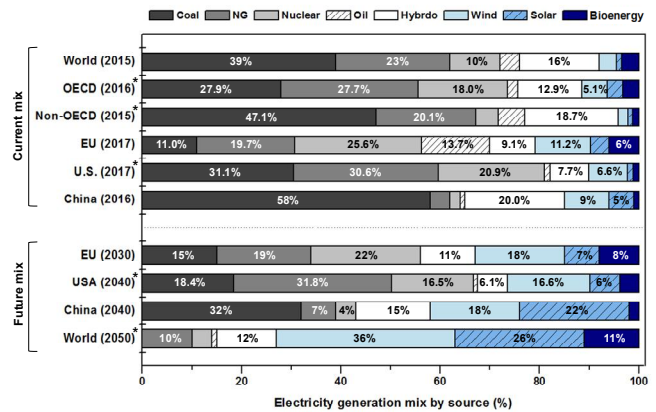

Fig. 8. Current and expected electricity generation mix by sources and regions (IRENA, 2018; IEA, 2017, 2018; EIA, 2015, 2018; Sandbag & Agora Energiewende, 2018; EU, 2016).

5. Results and Future Works

Figs. 9-12 present a comparison of the emission factors for each emission type from conventional ship gensets and AMP when used to supply electricity to ships at berth. In the case of ship gensets,

Analysis of the Emission Benefits of Using Alternative Maritime Power (AMP) for Ships

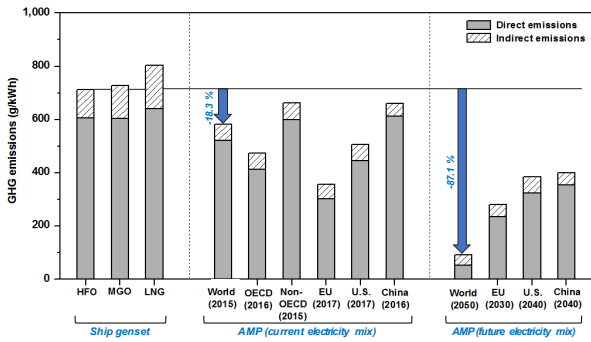

Fig. 9. Comparison of GHG emissions between ship genset and AMP for electricity supply.

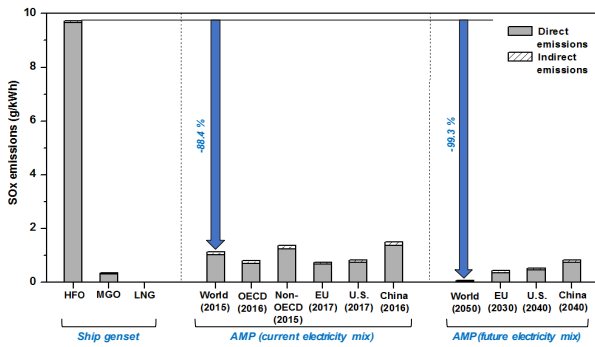

Fig. 10. Comparison of SO_x emissions between ship genset and AMP for electricity supply.

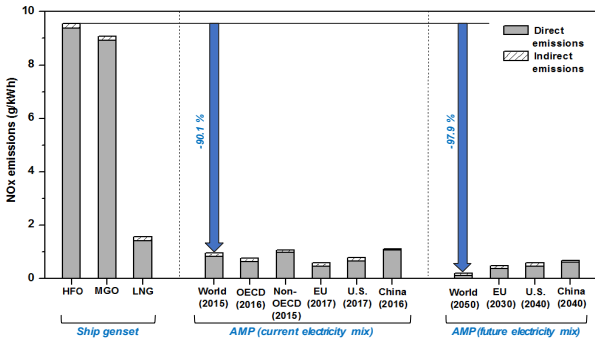

Fig. 11. Comparison of NO_x emissions between ship genset and AMP for electricity supply.

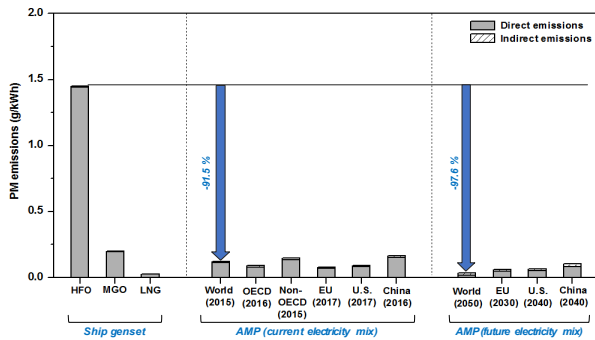

Fig. 12. Comparison of PM emissions between ship genset and AMP for electricity supply.

the emission factors were derived from Table 6, and for the emission factors of AMP, Equation (9) was applied based on Table 7 and Fig. 8.

It is clear that AMP produces lower emissions for all emission types than do gensets. First, the global average of GHG emissions were reduced by about 18.3%. In particular, the harmful pollutions of SO_x, NO_x, and PM were significantly reduced by 88.4%, 90.1%, and 91.5% on average, respectively. Even though no significant decrease in GHG emissions was observed for non-OECD countries, the other harmful emissions were greatly reduced. It is expected that China will be able to substantially cut its emissions because its coal-intensive electricity generation mix will be replaced by renewable sources by 2030 (e.g., wind 18%, solar 22%, etc.).

In addition, the environmental benefits of AMP will increase further because of an improved electricity mix globally. By 2050, GHG emissions are predicted to fall by 87.1% globally compared to those generated by conventional genset fuel (HFO); SO_x by up to 99.3%, NO_x by up to 97.9%, and PM by up to 97.6%. Even though the efficiency of power plants and the pathways from raw materials vary by region, these comparison results could be used to consider the general environmental benefits of AMP.

Additionally, the required electric power and staying time at a port are highly dependent on ship type and size, and it is related to the amount of emissions according to Equation (3). Based on the emission factors obtained in Chapters. 3 and 4, the total GHG emissions by ship type was calculated in Table 8. The results show that a cruise ship for regional voyages generates the largest amount of emissions among all ship types due to the high electric power demands and long spending time at a port. Therefore, it is highly recommended that this kind of ship use AMP. A more detailed analysis considering specific ship types and sizes will be performed in the future.

Furthermore, both the shipping industry and the electric power industry have been trying new approaches to reduce harmful emissions. In the shipping industry, alternative fuels have been suggested, including biofuel, methanol, hydrogen, and ammonia. Therefore, it is necessary to compare emissions from other alternative fuels with emissions from the AMP in the near future.

Likewise, from the perspective of the electric power industry, alternative low-carbon power sources such as renewable energy have become preferable for electricity generation. And emissions from coal-based power plants could be reduced by applying an integrated gasification combined cycle (IGCC), fuel gas cleaning

Table 8. Comparison of GHG emissions between ship genset and AMP for electricity supply while at berth depending on ship type.

Ship type	Average required power at a port (kW) ^a	No. of visits at the same port (p.a.) ^a	Time at a port per visit (hours) ^a	GHG emissions from ship genset(s) (ton/yr)			GHG emissions from AMP (ton/yr)
				HFO	MGO	LNG	
Cruise (≥250m, regional voyages)	10,000	16	15	1,706.42	1,745.93	1,930.30	1,394.38
Cruise (≥250m, global voyages)	10,000	2	15	213.30	218.24	241.29	174.30
Ro-ro / ro-pax / ferry	1,500	156	6	998.26	1021.37	1129.22	815.71
Container (≥2,500 TEU feeder service)	1,200	52	9	399.30	408.55	451.69	326.28
Container (≥5,000 TEU global service)	2,500	8	24	341.28	349.19	386.06	278.88
Tanker	1,200	20	24	409.54	419.02	463.27	334.65
Bulk	800	5	168	477.80	488.86	540.48	390.43

^a Source: Petr Guryev (2014).

(FGC), or carbon capture storage (CCS).

It is also expected that the number of AMP facilities at ports will increase worldwide. In particular, the European Parliament has decided to require AMP at the Trans-European Transport (Ten-T) Core Network of European ports by December 31, 2025; the Ten-T Core Network consists of the 80 most important ports in Europe (Barrenechea, 2017). The Chinese government also recently issued its 13th Five-Year Plan, which included plans for emission control at major ports. It has been reported that 493 berths in China will be equipped with AMP facilities by 2020 and the government is subsidizing their implementation (WRI, 2017).

Together with AMP promotion policies, it is essential to calculate the maximum expected electricity demand for AMP to ensure that power grids can handle this demand and remain stable.

6. Conclusions

Even though some major ports have already been installed and are using AMP facilities, especially in ECAs, there are still doubts about their ultimate environmental benefits due to the increase in electric power demand. To better understand the potential role of AMP as a genuine eco-friendly solution, this study conducted a comparison of the emissions generated by conventional ship-based gensets and shore-based AMP. The focus was on four main emission types (GHG, SO_x, NO_x, and PM) which are currently under regulation or under consideration for regulation by the IMO.

For ship genset emissions, HFO, MGO, and LNG were selected. HFO and MGO are the most commonly used fuels, and LNG is the most favorable alternative fuel in the marine industry. AMP emissions, on the other hand, were calculated based on the electricity mix of eight different types of power source. For a fair

comparison of the environmental impacts, both direct and indirect emissions were considered for each fuel or power source.

The results of this study are summarized as follows.

- Compared to ship gensets using HFO, AMP could effectively reduce harmful emissions; specially, the reduction rates of SO_x, NO_x, and PM would be about 88 - 92 %.
- Compared to ship gensets using MDO or LNG, AMP could be environmentally beneficial; specially, AMP has an 89.6 % lower rate of NO_x emissions than MGO and a 27.8 % lower rate of GHG emissions than LNG.
- Indirect emissions have a significant impact on emissions overall, so it is necessary to reduce both indirect and direct emissions together.
- The environmental benefits of AMP are expected to increase in the future, and it highly depends on efforts to reduce coal and oil-fired power plants.

This study showed the environmental benefits of AMP through comparative analysis. Even though this study was by necessity based on assumptions for the calculation of emission factors, the findings can help ship owners and port authorities determine optimal policies to best meet stricter environmental regulations.

References

- [1] ABB(2017). Shore-to-ship Power Converters ACS6000 SFC & PCS100 SFC Description, p. 54.
- [2] ABS(2017), ABS Advisory on exhaust gas scrubber systems, p. 37.
- [3] AQEG(Air Quality Expert Group)(2017), The Potential Air

Analysis of the Emission Benefits of Using Alternative Maritime Power (AMP) for Ships

- Quality Impacts from Biomass Combustion. Crown, p. 31.
- [4] Barrenechea, A.(2017), Reykjavik Harbor System Analysis: Shore Side Electricity Connections for Containerships in the Eimskip Terminal, Thesis of Master degree, p. 9.
- [5] Bates, J. and S. Henry(2009), Carbon factor for wood fuels for the Supplier Obligation Final report, AEA. Doc. No. AEA/ED01858010/Issue2, pp. 6-12.
- [6] Cai, H., M. Wang, A. Elgowainy and J. Han(2012), Updated greenhouse gas and criteria air pollutant emission factors and their probability distribution functions for electricity generating units, Argonne National Laboratory (ANL), Report No. ANL/ESD/12-2, p. 33.
- [7] Castelazo, E. S.(2011), Sustainability Assessment of Electricity Options for Mexico: Current Situation and Future Scenarios. School of Chemical Engineering and Analytical Science. p. 157.
- [8] CEC(Commission for Environmental Cooperation of North America)(2004), North American Power Plant Air Emissions, 23-32, pp. 44-49.
- [9] Clarksons Research(2017), Summary of Selected Shipping, Regulation and Design Issues, Retrieved from https://www.clarksons.net/docdata/public/newsdownloads/Environmental_Table_September_2017.pdf (Accessed: 1 Aug. 2018).
- [10] Clarksons Research(2018), Environmental and Regulatory Update - Presentation to Shipbuilding Forecast Club, p. 6.
- [11] CO₂ emissiefactoren(2017), Lijst emissiefactoren, Retrieved from <https://www.CO2emissiefactoren.nl/lijest-emissiefactoren/> (Accessed: 6 Aug. 2018).
- [12] DEA(Danish Energy Agency)(2016), Technology Data for Energy Plants Updated chapters, ENERGINET, p. 39.
- [13] Devasahayam, S., K. Dowling and M. K. Mahapatra(2017), Sustainability in the mineral and energy sectors, CRC Press.
- [14] EIA(U.S. Energy Information Administration)(2013), The mix of fuels used for electricity generation in the United States is changing, Article (Issued: 8 Nov. 2013), Retrieved from <https://www.eia.gov/todayinenergy/detail.php?id=13731> (Accessed: 22 July 2018).
- [15] EIA(U.S. Energy Information Administration)(2015), Analysis of the Impacts of the Clean Power Plan, p. 23.
- [16] EIA(U.S. Energy Information Administration)(2018), Monthly Energy Review (May 2018), Doc. No. DOE/EIA-0035(2018/5), p. 112.
- [17] EPA(United States Environmental Protection Agency)(2017), Shore Power Technology Assessment at U.S. Ports, Report No. EPA-420-R-17-004, p. 12, pp. 17-18.
- [18] ERG(Eastern Research Group) and EERA(Energy & Environmental Research Associates)(2017), Shore Power Technology Assessment at U.S. Ports. Technical Report for EPA. Doc. No. EPA -420-R-17-004, p. 10.
- [19] EU(European Commission)(2016), EU Reference Scenario 2016 - Energy, transport and GHG emissions Trends to 2050, p. 66.
- [20] FEPC(Federation of Electric Power Companies)(2014), Graphical Flip-chart of Nuclear & Energy Related Topics 2014.
- [21] Gilbert, P., C. Walsh, M. Traut, U.Kesieme, K. Pazouki and A. Murphy(2018), Assessment of full life-cycle air emissions of alternative shipping fuels, Journal of Cleaner Production, Vol. 172, pp. 855-866, doi: 10.1016/j.jclepro.2017.10.165.
- [22] Greenport(2017), Shore power could slash Norwegian emissions. Article, (Issued: 4 Sep 2017), Retrieved from <http://www.greenport.com/news101/energy-and-technology/shore-power-could-achieve-zero-emission-scandinavian-ports> (Accessed: 10 Aug. 2018).
- [23] Han, W. and K. Lim(2010), A Study on the Reduction of CO₂ Emissions and Operating Costs of the Ship in Port by Shore Electric Power, Journal of the Korean Society of Marine Environment & Safety (KOSOMES), Vol. 16, No. 2, pp. 229-234.
- [24] HATCH(2014), Lifecycle Assessment Literature Review of Nuclear, Wind and Natural Gas Power Generation prepared for The Canadian Nuclear Association, Doc. No. H345621-236-02, p. ix.
- [25] HATCH(2008), Lifecycle Emissions of Nuclear, Wind and Natural Gas Power Generation - CNA Summary, p. 8.
- [26] Hill, N., R. Bramwell and B. Harris(2017), 2017 Government GHG conversion factors for company reporting - Methodology Paper for Emission Factors. Final Report, Department for Business Energy & Industrial Strategy (BEIS), p. 13, p. 394.
- [27] Holdway, A. R., A. R. Williams, O. R. Inderwildi and D. A. King(2010), Indirect emissions from electric vehicles: emissions from electricity generation, Energy & Environmental Science, Vol. 3, No. 12, pp. 1825-1832.
- [28] ICF(2013), Yukon Power Plant Fuel Life Cycle Analysis, Final Report (Released: 2 July 2013), p. iii.
- [29] IEA(International Energy Agency)(2017), Electricity Information: Overview, Statistics Report, pp. 4-5.

- [30] IEA(International Energy Agency)(2018), World Energy Outlook 2017: China, Retrieved from <https://www.iea.org/weo/china/> (Accessed: 11 July 2018).
- [31] IMO(2015), Third IMO Greenhouse Gas Study 2014, p. 104, pp. 249-250.
- [32] IMO(2016), Module 5 - Ship Port Interface for Energy Efficiency, IMO Train the Trainer (TTT) Course on Energy Efficient Ship Operation, p. 28.
- [33] IMO(2017a), 2014 Guidelines on the method of calculation of the attained energy efficiency design index (EEDI) for new ships, as amended (Resolution MEPC. 245 (66)-as amended by Resolutions MEPC.263 (68) and MEPC.281 (70)), Doc. No. MEPC.1/Circ.866 (Issued: 30 Jan. 2017), p. 3.
- [34] IMO(2017b), FAQ (Frequently Asked Questions) - The 2020 global sulphur limit.
- [35] IMO(2018), Marine Environment Protection Committee (MEPC), 72nd session, 9-13 April 2018, Issued: 13 April 2018, Retrieved from <http://www.imo.org/en/MediaCentre/MeetingSummaries/MEPC/Pages/MEPC-72nd-session.aspx> (Accessed: 3 July 2018).
- [36] IPCC(2014), 5th Assessment Report (AR5), Chapter 8- Anthropogenic and Natural Radiative Forcing, p. 731.
- [37] IRENA(International Renewable Energy Agency)(2018), Global Energy Transformation - A Roadmap to 2050, Report No. ISBN 978-92-9260-059-4, pp. 31-32, p. 39.
- [38] Ke, W., S. Zhang, X. He, Y. Wu and J. Hao(2017), Well-to-wheels energy consumption and emissions of electric vehicles: Mid-term implications from real-world features and air pollution control progress, Applied Energy, Vol. 188, pp. 367-377, doi: 10.1016/j.apenergy.2016.12.011.
- [39] Khaenson, W., S. Maneewan and C. Punlek(2017), A Comparison of the Environmental Impact of Solar Power Generation Using Multicrystalline Silicon and Thin Film of Amorphous Silicon Solar Cells: Case Study in Thailand, Journal of Ecological Engineering, Vol. 18, No. 4, pp. 1-14, doi: 10.12911/22998993/74386.
- [40] Khartchenko, N. V. and V. M. Kharchenko(2014), Advanced Energy Systems, 2nd Edition, CRC Press, p. 265.
- [41] Kristenen, H. O.(2015), Energy demand and exhaust gas emissions of marine engines. Project No. 2014-122, p. 6, p. 23.
- [42] Kristensen, P. G., J. K. Jensen, M. Nielsen and J. B. Illerup(2004), Emission factors for gas fired CHP units < 25 MW. IGRC, p. 18.
- [43] Krittayakasem, P., S. Patumsawadand S. Garivait(2011), Emission inventory of electricity generation in Thailand, Journal of Sustainable Energy & Environment, Vol. 2, No. 2, p. 67.
- [44] Kuo, P.(2014), Should UC Berkeley Use Community Choice Aggregation (CCA) to Achieve Zero-Carbon Electricity By 2025?, Class project for CE268, p. 5.
- [45] Liu, H., M. Fu, X. Jin, Y. Shang, D. Shindell, G. Faluvegi, C. Shindell and K. He(2016), Health and climate impacts of ocean-going vessels in East Asia, Nature climate change, Vol. 6, No. 11, p. 1037, doi: 10.1038/nclimate3083.
- [46] Lopez-Aparicio, S. and D. A. Tønnesen(2015), Pollutant emissions from LNG fuelled ships - Assessment and recommendations, Scientific Report, NILU (Norwegian Institute for Air Research), p. 10.
- [47] Louwen, A.(2011), Comparison of the life cycle greenhouse gas emissions of shale gas, conventional fuels and renewable alternatives from a Dutch perspective, Utrecht University in Netherlands, p. 43.
- [48] Lowell, D., H. Wang and N. Lutsey(2013), Assessment of the fuel cycle impact of liquefied natural gas as used in international shipping, ICCT White paper, p. 23.
- [49] Lueken, R., K. Klima, W. M. Griffin and J. Apt(2016), The climate and health effects of a USA switch from coal to gas electricity generation, Energy, Vol. 109, p. 1162, doi: 10.1016/j.energy.2016.03.078
- [50] MAK(2015), VM32E Technical Brochure. Standard model (VM32E).
- [51] MAN(2018), Marine Gensets - Overview, Retrieved from <https://marine.man-es.com/gensets/marine-gensets> (Accessed: 19 July 2018).
- [52] MARINE(2017), Sea Shipping Emissions 2015: Netherlands Continental Shelf, 12-mile Zone and Port Areas, Report No. 29555-1-MSCN-rev.2 (Issued: 16 June 2017), pp. A11-A13.
- [53] MARINE(2018), Sea Shipping Emissions 2016: Netherlands Continental Shelf, 12-mile Zone and Port Areas, Report No. 30508-1-MSCN-rev.0 (Released: 18 Jan 2018), pp. A9, 11-13.
- [54] Marinelog(2017), Get ready for China's ECA requirements, Newsletter. Retrieved from https://www.marinelog.com/index.php?option=com_k2&view=item&id=27975:get-ready-for-china%E2%80%99s-eca-requirements&Itemid=257 (Accessed: 17 July 2018).
- [55] Molly, N.(2016), The IMO's 2020 global sulfur cap - What a 2020 sulfur-constrained world means for shipping lines, Refineries and bunker suppliers. Shipping Special Report,

Analysis of the Emission Benefits of Using Alternative Maritime Power (AMP) for Ships

- S&P Global Platts, p. 2.
- [56] Moreno-Gutiérrez, J., V. Durán-Grados, Z. Uriondo and J. Ángel Llamas(2012), Emission-factor uncertainties in maritime transport in the Strait of Gibraltar, Spain, Atmospheric Measurement Techniques Discussions, Vol. 5, No. 4, p. 5974.
- [57] Moro, A. and L. Lonza(2017), Electricity carbon intensity in European Member States: Impacts on GHG emissions of electric vehicles, Transportation Research Part D: Transport and Environment, doi: 10.1016/j.trd.2017.07.012.
- [58] Nicewicz, G. and D. Tarpanowicz(2012), Assessment of marine auxiliary engines load factor in ports, Management Systems in Production Engineering, pp. 12-17.
- [59] Olmer, N., B. Comer, B. Roy, X. Mao and D. Rutherford (2017), Greenhouse gas emissions from global shipping 2013 - 2015 - Detailed methodology, ICCT (The International Council on Clean Transportation), p. 52.
- [60] Ozawa, A., M. Inoue, N. Kitagawa, R. Muramatsu, Y. Anzai, Y. Genchi and Y. Kudoh(2017), Assessing Uncertainties of Well-To-Tank Greenhouse Gas Emissions from Hydrogen Supply Chains, Sustainability, Vol. 9, No. 7, 1101, doi:10.3390/su9071101.
- [61] Pant, D. and S. I. Olsen(2013), Life Cycle Assessment of Renewable Energy Sources, Springer, p. 231.
- [62] Peng, C. S.(2016), Application of Shore Power for Ocean Going Vessels at Berth in China. DEStech Transactions on Environment, Energy and Earth Sciences (seeie), p. 9, doi: 10.12783/dteees/seeie2016/4489.
- [63] Peng, T., S. Zhou, Z. Yuan and X. Ou(2017), Life cycle greenhouse gas analysis of multiple vehicle fuel pathways in China, Sustainability, Vol. 9, No. 12, p. 2183, doi: 10.3390/su9122183.
- [64] Petr Guryev(2014), Analyzing the cost efficiency of emissions reduction with shore-to-ship power, ABB review 4(14), p. 66-69.
- [65] Rolls-Royce(2017), Project Guide Bergen Engine Type B35: 40 Gas, Technical data (Model No. B35:40 L9AG), p. 3.
- [66] Rolls-Royce(2018), Bergen B32:40V genset, Retrieved from <https://www.rolls-royce.com/products-and-services/marine/product-finder/generating-sets/diesel-generating-sets.aspx> (Accessed: 8 Aug. 2018).
- [67] Sandbag & Agora Energiewende(2018), The European Power Sector in 2017 - State of Affairs and Review of Current Developments, Doc. No. 128/02-A-2018/EN, p. 7.
- [68] Schmied, M. and W. Knörr(2012), Calculating GHG emissions for freight forwarding and logistics services in accordance with EN 16258 - Terms, Methods, Examples. European Association for Forwarding, Transport, Logistics and Customs Services (CLECAT), p. 11, p. 26, p. 55, p. 61.
- [69] Schneider-electric(2015), Low Voltage and Medium Voltage Products - Power and Distribution Transformers, Catalogue, p. 25.
- [70] Skone, T. J., J. Littlefield, G. Cooney and J. Marriott (2013), Power generation technology comparison from a life cycle perspective, National Energy Technology Laboratory (NETL), US Department of Energy (DOE). Doc. No. DOE/NETL-2012/1567, p. ix.
- [71] Skone, T. J., G. Cooney, M. Jamieson, J. Littlefield and J. Marriott.(2014), Life Cycle Greenhouse Gas Perspective on exporting liquefied natural gas from the United States. National Energy Technology Laboratory (NETL), US Department of Energy (DOE), Doc. No. NETL-2014/1649, pp. 11-12.
- [72] Starcrest Consulting Group(2017), White Bay Cruise Terminal Shore Power Analysis. Final Report for Port Authority of New South Wales (Accessed: 30 July 2018).
- [73] Stenersen, D. and O. Thonstad(2017), GHG and NOx emissions from gas fuelled engines, SINTEF Ocean AS Report (Issued: 13 June 2017), p. 6.
- [74] ThinkStep(2017), Greenhouse Gas Intensity of Natural Gas, Final Report on behalf of NGVA Europe (Issued: 5 May 2017), p. 89.
- [75] Trozzi, C.(2010), Emission estimate methodology for maritime navigation. 19th International Emission Inventory Conference, Emission Inventories - Informing Emerging Issues, San Antonio, Texas, 27 - 30 Sep. 2010, p. 6.
- [76] Turconi, R., A. Boldrin and T. Astrup(2013), Life cycle assessment (LCA) of electricity generation technologies: Overview, comparability and limitations, Renewable and sustainable energy reviews, Vol. 28, pp. 555-565, doi: 10.1016/j.rser.2013.08.013.
- [77] Vaishnav, P., P. S.Fischbeck, M. G. Morgan and J. J. Corbett (2016), Shore Power for Vessels Calling at US Ports: Benefits and Costs, Environmental Science & Technology, Vol. 50, No. 3, pp. 1102-1110, doi: 10.1021/acs.est.5b04860.
- [78] Wang, H., X. Mao and D. Rutherford(2015), Costs and benefits of shore power at the port of Shenzhen, The International Council on Clean Transportation (ICCT).
- [79] Wärtsilä(2017), Wärtsilä 31 Product Guide, Technical Data,

Model No. Wärtsilä 8V31 (Issued: 28 Sep. 2017), p. 3-2.

- [80] WNA(World Nuclear Association)(2017), Comparison of Lifecycle Greenhouse Gas Emissions of Various Electricity Generation Sources, pp. 6-7.
- [81] Woo, J., H. Choi and J. Ahn(2017), Well-to-wheel analysis of greenhouse gas emissions for electric vehicles based on electricity generation mix: A global perspective, Transportation Research Part D: Transport and Environment, Vol. 51, pp. 340-350, doi: 10.1016/j.trd.2017.01.005.
- [82] WRI(World Resources Institute)(2017), A clean Air Challenge for China's Ports: Cutting Maritime Emissions, (Issued: 24 Oct. 2017), Retrieved from <http://www.wri.org/blog/2017/10/clean-air-challenge-chinas-ports-cutting-maritime-emissions> (Accessed: 21 July 2018).
- [83] Xcel Energy(2018), Inside your 2018 electric bill, Brochure.
- [84] Yuksel, T., M. A. M. Tamayao, C. Hendrickson, I. M. Azevedo and J. J. Michalek(2016), Effect of regional grid mix, driving patterns and climate on the comparative carbon footprint of gasoline and plug-in electric vehicles in the United States, Environmental Research Letters, Vol. 11, No. 4, No. 044007.

Received : 2019. 04. 15.

Revised : 2019. 05. 27.

Accepted : 2019. 05. 28.