

Advanced Channel Estimation Method for IEEE 802.11p/WAVE System

DongSeon Jang

Dept. of Information Technology Convergence
Korea National University of Transportation, Korea

Kyunbyoung Ko

Dept. of Information Technology Convergence and
Dept. of Electronics Engineering
Korea National University of Transportation, Korea

ABSTRACT

In this paper, we propose an advanced Minimum Mean Square Error (MMSE) channel estimation method for IEEE 802.11p/Wireless Access in Vehicular Environments (WAVE) systems. To improve the performance of MMSE method, we apply the Weighted Sum using Update Matrix (WSUM) scheme to the step of calculating the instantaneously estimated channel and then, a time domain selectively averaging method is applied after the WSUM scheme. Based on that, the accuracy of instantaneously estimated channel increases and then, the accuracy of auto covariance matrix also increases. Consequently, we can achieve the performance gain over the conventional MMSE method. Through simulations based on the IEEE 802.11p standard, it is confirmed that the proposed scheme can outperform the existing channel estimation schemes.

Key words: IEEE 802.11p, WAVE, MMSE, WSUM.

1. INTRODUCTION

Many researches have been widely discussed on a cooperative intelligent transportation system (C-ITS) to actively respond to traffic situations through real-time intercommunication with surrounding vehicles and infrastructure while the vehicle is moving [1]-[4]. To support vehicle radio (i.e., vehicle-to-vehicle (V2V) and vehicle-to-infrastructure (V2I)) communications, IEEE 802.11p standard was developed to define the medium access control (MAC) and physical layer (PHY) of a WLAN [1].

Note that IEEE 802.11p was based on modifying the frequency bandwidth of the IEEE 802.11a standard from 20MHz to 10MHz [1]. It means that IEEE 802.11p has only four pilot subcarriers during one symbol period and we cannot accurately estimate the channel variation occurring in the frequency domain with only four pilot subcarriers. Therefore, it is necessary to accurately estimate the rapidly time-varying channel in order to stably provide the traffic information to the moving vehicle. Therefore, various improved channel estimation techniques for IEEE 802.11p/Wireless Access in

Vehicular Environments (WAVE) systems have been continuously researched [1]-[8]. For example, spectral temporal averaging (STA), construct data pilot (CDP), time-domain reliable-test frequency-domain interpolation (TRFI), weighted sum using update matrix (WSUM), and minimum mean square error (MMSE) channel estimation schemes have been proposed [4]-[8].

STA scheme can give better performance at lower Signal-to-Noise Ratio (SNR) region and lower modulation order. To overcome the disadvantage of STA scheme, CDP scheme was proposed [4]. Also, TRFI, MMSE, and WSUM schemes were presented to improve the performance of CDP scheme so that they can give better performance than CDP and STA at higher SNR region and higher modulation order [5], [6], [8]. As shown in [8], WSUM scheme can be regarded as a weighted averaging scheme in frequency domain when it is compared with STA scheme. MMSE scheme in [6] has the limitation even though it requires higher complexity related with matrix inversion. So, the authors in [7] presented an adaptive mode switching method between channel estimation schemes.

Up to now, to the best of our knowledge, there has been no research on the channel estimation scheme which can give better performance than STA at high SNR region while maintaining STA at low SNR.

In this paper, for IEEE 802.11p/WAVE system, we propose an advanced MMSE channel estimation method based on both a WSUM scheme and a Time-Domain Averaging

This is an excellent paper selected from the papers presented at ICC 2018.

* Corresponding author, Email: kbko@ut.ac.kr

Manuscript received Jun. 11, 2019; revised Nov. 25, 2019; accepted Nov. 29, 2019

(TDA). In proposed method, WSUM scheme is applied at the first step and then, we use a TDA method which is averaging the estimated channel values on the time-domain based on the similarity of the channel states of adjacent orthogonal frequency division multiplexing (OFDM) symbols. At third step, auto covariance matrix is updated by using a channel estimation value obtained after TDA method. Finally, the channel estimation value is obtained by applying MMSE method. Note that auto covariance matrix can be updated through the sequential averaging. The performance of the proposed scheme according to the channel environment is verified by error rates.

The composition of the paper is as follows. Section 2 describes the IEEE 802.11p physical layer and the channel model used in the simulation. Section 3 presents previous channel estimation schemes. The proposed channel estimation scheme is described at Section 4. Section 5 presents simulation results of previous and proposed channel estimation methods. Finally, we conclude at Section 6.

2. SYSTEM MODEL

2.1 IEEE 802.11p physical layer

IEEE 802.11p has been standardized by modifying some specifications in the physical layer of the existing IEEE 802.11a. IEEE 802.11p utilizes a frequency of 5.9GHz (5.850 GHz ~ 5.925 GHz) and a bandwidth of 10MHz which is half of 802.11a bandwidth [1]. The size of Fast Fourier Transform (FFT) and Inverse Fast Fourier Transform (IFFT) is 64 [1].

Fig. 1 shows the packet structure of IEEE 802.11p [4], [8]. Generally, one packet has a preamble, a signal field, and a data field [1], [8]. The preamble located at the beginning of the packet has short training symbols used for time synchronization and long training symbols used for the initial channel estimation. IEEE 802.11p physical layer is based on OFDM. The Guard Interval (GI) is arranged to reduce Inter Symbol Interference (ISI) due to the multipath fading channel. The signal field composed of one OFDM symbol has information such as modulation order, code rate, and so on. On the other hand, the data field contains data to be transmitted and the number of OFDM symbols in data field can be variable according to data size. In this paper, it is assumed that the number of OFDM symbols in data field is $N_D = 100$ [8].

Fig.2 presents the packet structure of IEEE 802.11p on the frequency-axis (vertical) and time-axis (horizontal) [1], [4], [8]. The four pilot tones used for channel estimation are given as comb structure which is suitable for fast fading channel environment. By arranging pilot symbols in a specific frequency index (i.e., -21, -7, 7, and 21), we can define the set of pilot subcarrier indices as $S_p = \{-21, -7, 7, 21\}$. By ignoring null carriers (i.e., -32 to -27, 0, and 28 to 32), the set of data subcarrier indices, S_d , can be defined as satisfying $S_d \cup S_p = \{-26, -25, \dots, -1, 1, \dots, 25, 26\}$.

2.2 Channel model

In this paper, we use ‘Cohda Wireless channel model’ proposed by Malik Kahn in which, according to the driving environment and location of the vehicle, five scenarios are shown as Rural LOS with 144km/h, Urban Approaching LOS with 119km/h, Crossing NLOS with 126km/h, Highway LOS with 252km/h, and Highway NLOS with 252km/h [2]. With respect to relative speed between vehicles, Delay profile and Doppler shift are presented and then, the Doppler profile is given by using a Tapped Delay Line (TDL) model [2]. In each scenario, the number of taps is given and then, the location and the average power of each tap are defined differently. For simulation in this paper, we utilize Rural LOS with 144km/h and Highway LOS with 252km/h.

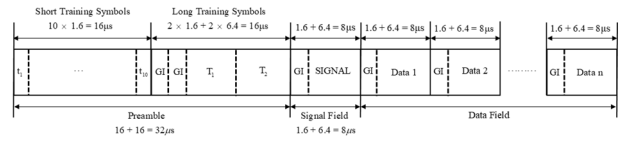

Fig. 1. IEEE 802.11p packet structure

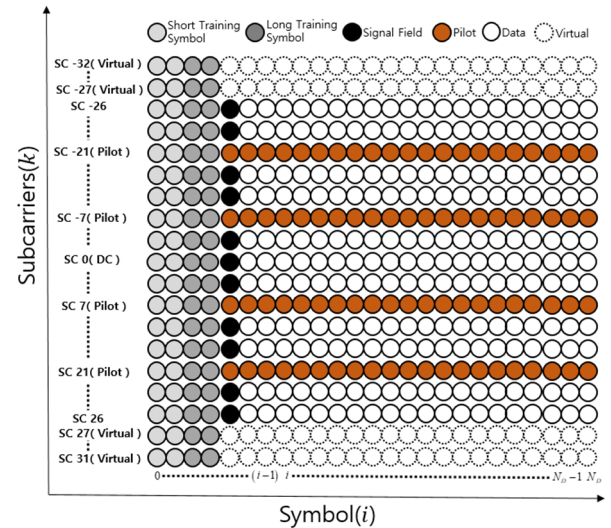

Fig. 2. Packet structure in WAVE frequency and time domain

3. CHANNEL ESTIMATION SCHEMES FOR THE IEEE 802.11p

In this section, we describe the existing channel estimation schemes such as STA, CDP, WSUM, and MMSE [4], [6]-[8].

3.1 Spectral Temporal Averaging (STA) scheme

The STA method has been proposed as an estimation technique for adapting to time-varying channels when the vehicle is traveling at high speed [4], [8].

■ Equalization

At first, we can use the initial channel estimation coefficient by the Least Square (LS) method for two long preambles (i.e., $Y_1^T(k)$ and $Y_2^T(k)$) as follow:

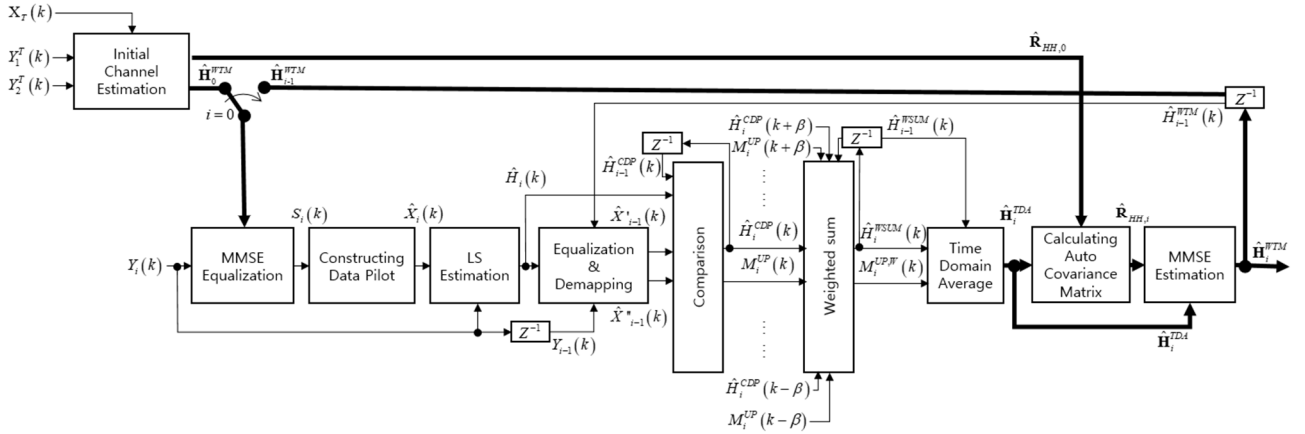

Fig. 3. Proposed channel estimation scheme

$$\hat{H}_0(k) = \frac{Y_1^T(k) + Y_2^T(k)}{2X^T(k)}, \quad k \in (S_d \cup S_p) \quad (1)$$

Here, $X^T(k)$ is the long training symbol of the k th subcarrier and it is known to the receiver. Note that S_p and S_d are the sets of pilot subcarrier indices and data subcarrier indices, respectively.

The received signal of the k th subcarrier in the i th data field, $Y_i(k)$, is equalized using the $(i-1)$ th estimated channel value $\hat{H}_{i-1}^{STA}(k)$ as follows:

$$S_i(k) = Y_i(k) / \hat{H}_{i-1}^{STA}(k), \quad k \in S_d \quad (2)$$

Note for $i=0$ that we can set $\hat{H}_0^{STA}(k) = \hat{H}_0(k)$ from (1).

■ Constructing Data Pilot

The constructed data pilot, $\hat{X}_i(k)$, can be determined by using $S_i(k)$ of (2) and after demapping as follow:

$$\hat{X}_i(k) = \begin{cases} D(S_i(k)), & k \in S_d \\ X_i^p(k), & \text{else} \end{cases} \quad (3)$$

where $D(r)$ is a function that maps the equalized signal to the corresponding modulation scheme. Then, $X_i^p(k)|_{k=-21, -7, 7, 21}$ are predefined frequency domain pilot symbols in the standard.

■ Least Square (LS) Method

The initial channel estimation value $\hat{H}_i(k)$ can be obtained by equalizing $Y_i(k)$ with $\hat{X}_i(k)$ of (3) as

$$\hat{H}_i(k) = Y_i(k) / \hat{X}_i(k), \quad k \in (S_d \cup S_p). \quad (4)$$

■ Frequency-Domain Averaging

In order to mitigate the channel estimation error due to demapping error, the estimated channel value can be averaged in the frequency domain as

$$\hat{H}_i^{FDA}(k) = \sum_{\lambda=-\beta}^{\beta} \omega_{\lambda} \hat{H}_i(k + \lambda), \quad k \in (S_d \cup S_p) \quad (5)$$

where $\omega_{\lambda} = 1 / (2\beta + 1)$ is a weighting coefficient and $(2\beta + 1)$ represents the number of averaging subcarriers [4], [8].

■ Time-Domain Averaging

Next, by applying time domain averaging, we can get the estimated channel coefficient of

$$\hat{H}_i^{STA}(k) = \left(1 - \frac{1}{\alpha}\right) \hat{H}_{i-1}^{STA}(k) + \frac{1}{\alpha} \hat{H}_i^{FDA}(k), \quad k \in (S_d \cup S_p) \quad (6)$$

where α is a weight coefficient in the time domain. In this paper, we use $\alpha = \beta = 2$ as shown in [7] and [8].

For the i th data field, $\hat{H}_i^{STA}(k)$ of (6) can be used and then, for the next $(i+1)$ th data field, we can go to the step of Eq. (2).

3.2 Constructed Data Pilot (CDP) scheme

Two adjacent OFDM symbols in the time domain have a high channel correlation. By using this relationship, the reliability of the initially estimated channel value can be determined, and the estimated channel value with higher reliability is selected [4], [8]. The CDP scheme is similar to the STA scheme from equalization of (1) to LS of (4). In addition, $\hat{H}_0^{CDP}(k) = \hat{H}_0(k)$ is used.

■ Equalization and Demapping

Using the initially estimated channel value $\hat{H}_i(k)$ of (4) and the $(i-1)$ th OFDM symbol's CDP channel estimation value $\hat{H}_{i-1}^{CDP}(k)$, we can equalize the previous received data symbols as follows [4]:

$$\begin{aligned} S'_{i-1}(k) &= Y_{i-1}(k) / \hat{H}_i(k), \quad k \in S_d \\ S''_{i-1}(k) &= Y_{i-1}(k) / \hat{H}_{i-1}^{CDP}(k), \quad k \in S_d \end{aligned} \quad (7-1)$$

Then, both $S'_{i-1}(k)$ and $S''_{i-1}(k)$ can be demapped to $\hat{X}'_{i-1}(k)$ and $\hat{X}''_{i-1}(k)$ according to the modulation scheme as [4]

$$\begin{aligned} \hat{X}'_{i-1}(k) &= D(S'_{i-1}(k)), \quad k \in S_d \\ \hat{X}''_{i-1}(k) &= D(S''_{i-1}(k)), \quad k \in S_d \end{aligned} \quad (8)$$

■ Comparison

If $\hat{H}_i(k)$ is correctly estimated, $\hat{H}_i(k)$ and $\hat{H}_{i-1}^{CDP}(k)$ can be similar because of the highly correlated characteristics for two adjacent subcarriers in the time domain. Using this relationship, the finally estimated channel coefficient for the CDP method can be obtained as [4]

$$\hat{H}_i^{CDP}(k) = \begin{cases} \hat{H}_i(k), & \text{if } \hat{X}'_{i-1}(k) = \hat{X}''_{i-1}(k) \text{ or } k \in S_p \\ \hat{H}_{i-1}^{CDP}(k), & \text{else} \end{cases} \quad (9-1)$$

For the i th data field, $\hat{H}_i^{CDP}(k)$ of (9-1) can be used and then, for the next $(i+1)$ th data field, we can go to the step of Eq. (2).

3.3 WSUM (Weighted Sum using Update Matrix) scheme

The WSUM scheme is a frequency domain weighted averaging channel estimation method using an updated matrix based on CDP scheme [8].

■ Initial Channel Estimation

For $i=0$, we can set $\hat{H}_0^{CDP}(k) = \hat{H}_0(k)$ from (1) and $M_0^{UP}(k) = 1$ with $k \in (S_d \cup S_p)$. Then, the initially estimated channel value can be expressed as [8]

$$\hat{H}_0^{WSUM}(k) = \frac{\sum_{\lambda=-\beta}^{\beta} \hat{H}_0(k+\lambda) M_0^{UP}(k+\lambda) \omega_\lambda}{\sum_{\lambda=-\beta}^{\beta} M_0^{UP}(k+\lambda) \omega_\lambda} \quad (10)$$

In this paper, we use $[\omega_{-1}, \omega_0, \omega_1] = [0.5, 1.0, 0.5]$.

■ WSUM Equalization

Similar with Eq. (2), the received signal of the k th subcarrier in the i th data field, $Y_i(k)$, is equalized using the $(i-1)$ th estimated channel value of $\hat{H}_{i-1}^{WSUM}(k)$ as follows:

$$S_i(k) = Y_i(k) / \hat{H}_{i-1}^{WSUM}(k), \quad k \in S_d \quad (11)$$

Note that for $i=1$, $\hat{H}_0^{WSUM}(k)$ of (10) is used in (11).

■ Constructing Data Pilot

From Eq. (3) with $S_i(k)$ of (11), we can get $\hat{X}_i(k)$.

■ Least Square (LS) Method

From Eq. (4) with $\hat{X}_i(k)$, we can get $\hat{H}_i(k)$.

■ Equalization and Demapping

From $\hat{H}_i(k)$ and $\hat{H}_{i-1}^{WSUM}(k)$, we can equalize the previous received data symbols as follows:

$$\begin{aligned} S'_{i-1}(k) &= Y_{i-1}(k) / \hat{H}_i(k), \quad k \in S_d \\ S''_{i-1}(k) &= Y_{i-1}(k) / \hat{H}_{i-1}^{WSUM}(k), \quad k \in S_d \end{aligned} \quad (7-2)$$

Then, both $S'_{i-1}(k)$ and $S''_{i-1}(k)$ can be demapped to $\hat{X}'_{i-1}(k)$ and $\hat{X}''_{i-1}(k)$ from Eq. (8).

■ Comparison

From $\hat{X}'_{i-1}(k)$, $\hat{X}''_{i-1}(k)$, $\hat{H}_i(k)$, $\hat{H}_{i-1}^{CDP}(k)$, and Eq. (9-1), we can get $\hat{H}_i^{CDP}(k)$. Then, the update matrix of the k th subcarrier in the i th data field can be obtained as

$$M_i^{UP}(k) = \begin{cases} 1, & \text{if } \hat{X}'_{i-1}(k) = \hat{X}''_{i-1}(k) \text{ or } k \in S_p \\ 0, & \text{else} \end{cases} \quad (9-2)$$

■ Weighted SUM (Frequency Domain Averaging)

Using the channel correlation of adjacent subcarriers in the frequency domain, the finally estimated channel gain can be obtained by weighted sum as follows:

$$\hat{H}_i^{WSUM}(k) = \begin{cases} \frac{\sum_{\lambda=-\beta}^{\beta} \hat{H}_i^{CDP}(k+\lambda) M_i^{UP}(k+\lambda) \omega_\lambda}{\sum_{\lambda=-\beta}^{\beta} M_i^{UP}(k+\lambda) \omega_\lambda}, & \text{if } \sum_{\lambda=-\beta}^{\beta} M_i^{UP}(k+\lambda) \geq N \\ \hat{H}_{i-1}^{WSUM}(k), & \text{else} \end{cases} \quad (12)$$

In this paper, $\beta=1$ and $N=2$ is used.

For the i th data field, $\hat{H}_i^{WSUM}(k)$ of (12) can be used and then, for the next $(i+1)$ th data field, we can go to the step of Eq. (11).

3.3 Minimum Mean Square Error (MMSE) scheme

The MMSE scheme is a technique that designates arbitrary virtual pilot subcarriers in frequency-domain received symbols

and utilizes them so as to improve the channel estimation performance [6], [7].

■ **Initial Channel Estimation**

For $i=0$, we can use $\hat{H}_0(k)$ of (1). Then, the initial auto covariance matrix can be expressed as

$$\hat{\mathbf{R}}_{HH,0} = \hat{\mathbf{H}}_0 \left(\hat{\mathbf{H}}_0 \right)^H \quad (13)$$

where $\hat{\mathbf{H}}_0 = [\hat{H}_0(-26) \cdots \hat{H}_0(-1) \hat{H}_0(1) \cdots \hat{H}_0(26)]^T$ is a 52×1 column vector. We use $(\cdot)^T$ for transpose of a matrix and $(\cdot)^H$ for conjugate transpose of a matrix. Then, the initial MMSE weight matrix is obtained as

$$\mathbf{W}_0^{MMSE} = \hat{\mathbf{R}}_{HH,0} \left(\hat{\mathbf{R}}_{HH,0} + \sigma^2 \mathbf{I} \right)^{-1} \quad (14)$$

where σ^2 is a variance of complex additive white Gaussian noise (AWGN) and \mathbf{I} is the 52×52 identity matrix. From $\hat{\mathbf{H}}_0$ and \mathbf{W}_0^{MMSE} , the initially MMSE estimated channel matrix can be obtained as

$$\hat{\mathbf{H}}_0^{MMSE} = \mathbf{W}_0^{MMSE} \hat{\mathbf{H}}_0. \quad (15)$$

Note that for the convenience of notation in $\hat{\mathbf{H}}_0^{MMSE}$ of (15), we use

$$\hat{\mathbf{H}}_0^{MMSE} = [\hat{H}_0^{MMSE}(-26) \cdots \hat{H}_0^{MMSE}(-1) \hat{H}_0^{MMSE}(1) \cdots \hat{H}_0^{MMSE}(26)]^T$$

as the element assignment.

■ **MMSE Equalization**

Similar with Eq. (2), the received signal of the k th subcarrier in the i th data field, $Y_i(k)$, is equalized using the $(i-1)$ th estimated channel value of $\hat{H}_{i-1}^{MMSE}(k)$ as follows:

$$S_i(k) = Y_i(k) / \hat{H}_{i-1}^{MMSE}(k), \quad k \in S_d \quad (16)$$

Note that for $i=1$, $\hat{H}_0^{MMSE}(k)$ within (15) is used in (16).

■ **Constructing Data Pilot**

From Eq. (3) with $S_i(k)$ of (16), we can get $\hat{X}_i(k)$.

■ **Least Square (LS) Method**

From Eq. (4) with $\hat{X}_i(k)$, we can get $\hat{H}_i(k)$.

■ **Updating Auto Covariance Matrix**

From $\hat{\mathbf{H}}_i = [\hat{H}_i(-26) \cdots \hat{H}_i(-1) \hat{H}_i(1) \cdots \hat{H}_i(26)]^T$ and $\hat{\mathbf{R}}_{HH,i-1}$, the auto covariance for the i th data field is updated as

$$\hat{\mathbf{R}}_{HH,i} = \frac{1}{i+1} \left(\hat{\mathbf{H}}_i \left(\hat{\mathbf{H}}_i \right)^H + i \times \hat{\mathbf{R}}_{HH,i-1} \right). \quad (17)$$

■ **MMSE Estimation**

Similar with (14), the MMSE weight matrix can be updated from $\hat{\mathbf{R}}_{HH,i}$ of (17) as

$$\mathbf{W}_i^{MMSE} = \hat{\mathbf{R}}_{HH,i} \left(\hat{\mathbf{R}}_{HH,i} + \sigma^2 \mathbf{I} \right)^{-1}. \quad (18)$$

Then, the MMSE estimated channel matrix can be expressed as

$$\hat{\mathbf{H}}_i^{MMSE} = \mathbf{W}_i^{MMSE} \hat{\mathbf{H}}_i \quad (19)$$

with $[\hat{H}_i^{MMSE}(-26) \cdots \hat{H}_i^{MMSE}(-1) \hat{H}_i^{MMSE}(1) \cdots \hat{H}_i^{MMSE}(26)]^T = \hat{\mathbf{H}}_i^{MMSE}$.

For the i th data field, $\hat{H}_i^{MMSE}(k)$ in (19) can be used and then, for the next $(i+1)$ th data field, we can go to the step of Eq. (16).

4. PROPOSED CHANNEL ESTIMATION METHOD

In the previous MMSE scheme [6], the performance is highly dependent on the accuracy of both the instantaneously estimated channel vector (i.e., $\hat{\mathbf{H}}_i$ in (19)) and the auto covariance matrix (i.e., $\hat{\mathbf{R}}_{HH,i}$ in (18)). Therefore, in order to improve the performance of MMSE scheme, we apply WSUM scheme to the step of calculating the instantaneously estimated channel $\hat{\mathbf{H}}_i$ in (19). Note that STA scheme can give better performance at low SNR by applying time domain averaging as shown in (6). In order to implement a time domain averaging, we propose a time domain selective averaging method after WSUM scheme. As the accuracy of $\hat{\mathbf{H}}_i$ increases, the accuracy of $\hat{\mathbf{R}}_{HH,i}$ increases, so performance can be improved in the proposed scheme.

4.1 WSUM-TDA-MMSE (WTM) scheme

■ **Initial Channel Estimation**

In the proposed scheme, we utilize the initial channel estimation of WSUM so that, for $i=0$, we can get $\hat{H}_0^{CDP}(k) = \hat{H}_0(k)$ from (1) and $\hat{H}_0^{TDA}(k) = \hat{H}_0^{WSUM}(k)$ from (10). Note that $\hat{H}_0^{TDA}(k) (= \hat{H}_0^{WSUM}(k))$ can be more accurate

than $\hat{H}_0(k)$. Therefore, we can get the initial auto covariance matrix of

$$\hat{\mathbf{R}}_{HH,0} = \hat{\mathbf{H}}_0^{TDA} \left(\hat{\mathbf{H}}_0^{TDA} \right)^H \quad (20)$$

with $\hat{\mathbf{H}}_0^{TDA} = \left[\hat{H}_0^{WSUM}(-26) \dots \hat{H}_0^{WSUM}(-1) \dots \hat{H}_0^{WSUM}(26) \right]^T$.

From Eq. (14) with $\hat{\mathbf{R}}_{HH,0}$ of (20), we can obtain \mathbf{W}_0^{MMSE} and then, the initially estimated channel matrix can be given as

$$\hat{\mathbf{H}}_0^{WTM} = \mathbf{W}_0^{MMSE} \hat{\mathbf{H}}_0^{TDA} \quad (21)$$

with

$$\left[\hat{H}_0^{WTM}(-26) \dots \hat{H}_0^{WTM}(-1) \hat{H}_0^{WTM}(1) \dots \hat{H}_0^{WTM}(26) \right]^T = \hat{\mathbf{H}}_0^{WTM}.$$

■ WTM Equalization

Similar with Eq. (16), we can get

$$S_i(k) = Y_i(k) / \hat{H}_{i-1}^{WTM}(k), \quad k \in S_d \quad (22)$$

Note that for $i=1$, $\hat{H}_0^{WTM}(k)$ of (21) is used in (22).

■ Constructing Data Pilot

From Eq. (3) with $S_i(k)$ of (16), we can get $\hat{X}_i(k)$.

■ Least Square (LS) Method

From Eq. (4) with $\hat{X}_i(k)$, we can get $\hat{H}_i(k)$.

■ Equalization and Demapping

From $\hat{H}_i(k)$ and $\hat{H}_{i-1}^{WTM}(k)$, we can equalize the previous received data symbols as follows:

$$\begin{aligned} S'_{i-1}(k) &= Y_{i-1}(k) / \hat{H}_i(k), \quad k \in S_d \\ S''_{i-1}(k) &= Y_{i-1}(k) / \hat{H}_{i-1}^{WTM}(k), \quad k \in S_d \end{aligned} \quad (23)$$

Then, both $S'_{i-1}(k)$ and $S''_{i-1}(k)$ can be demapped to $\hat{X}'_{i-1}(k)$ and $\hat{X}''_{i-1}(k)$ from Eq. (8).

■ Comparison

From $\hat{X}'_{i-1}(k)$, $\hat{X}''_{i-1}(k)$, $\hat{H}_i(k)$, and $\hat{H}_{i-1}^{CDP}(k)$, Eq. (9-1) gives $\hat{H}_i^{CDP}(k)$ and Eq. (9-2) gives $M_i^{UP}(k)$.

■ Weighted SUM (Frequency Domain Averaging)

From Eq. (12), we can get $\hat{H}_i^{WSUM}(k)$.

■ Time Domain Selective Averaging

Next, by applying time domain averaging, we can get the estimated channel coefficient of

$$\begin{aligned} &\hat{H}_i^{TDA}(k) \\ &= \begin{cases} \frac{\hat{H}_i^{WSUM}(k) + \hat{H}_{i-1}^{WSUM}(k)}{2}, & \text{if } k \in S_p \text{ or } M_i^{UP}(k) = 1 \\ \hat{H}_i^{WSUM}(k), & \text{else} \end{cases} \end{aligned} \quad (24)$$

■ Updating Auto Covariance Matrix

From $\hat{\mathbf{H}}_i^{TDA} = \left[\hat{H}_i^{TDA}(-26) \dots \hat{H}_i^{TDA}(-1) \dots \hat{H}_i^{TDA}(26) \right]^T$

and $\hat{\mathbf{R}}_{HH,i-1}$, the auto covariance for the i th data field can be obtained as

$$\hat{\mathbf{R}}_{HH,i} = \frac{1}{i+1} \left(\hat{\mathbf{H}}_i^{TDA} \left(\hat{\mathbf{H}}_i^{TDA} \right)^H + i \times \hat{\mathbf{R}}_{HH,i-1} \right). \quad (25)$$

■ MMSE Estimation

From Eq. (18) with $\hat{\mathbf{R}}_{HH,i}$ of (25), \mathbf{W}_i^{MMSE} can be obtained. Similar with (21), the MMSE estimated channel matrix can be expressed as

$$\hat{\mathbf{H}}_i^{WTM} = \mathbf{W}_i^{MMSE} \hat{\mathbf{H}}_i^{TDA} \quad (26)$$

with

$$\left[\hat{H}_i^{WTM}(-26) \dots \hat{H}_i^{WTM}(-1) \hat{H}_i^{WTM}(1) \dots \hat{H}_i^{WTM}(26) \right]^T = \hat{\mathbf{H}}_i^{WTM}.$$

For the i th data field, $\hat{H}_i^{WTM}(k)$ in (26) can be used and then, for the next $(i+1)$ th data field, we can go to the step of Eq. (22).

5. SIMULATION RESULTS

In this section, we show simulation results of the proposed schemes. In simulation with QPSK, 16QAM, and 'Code Rate=1/2', we utilize two scenarios (Rural LOS with 144km/h and Highway LOS with 252km/h) in 'Cohda Wireless channel model' proposed by Malik Kahn [2].

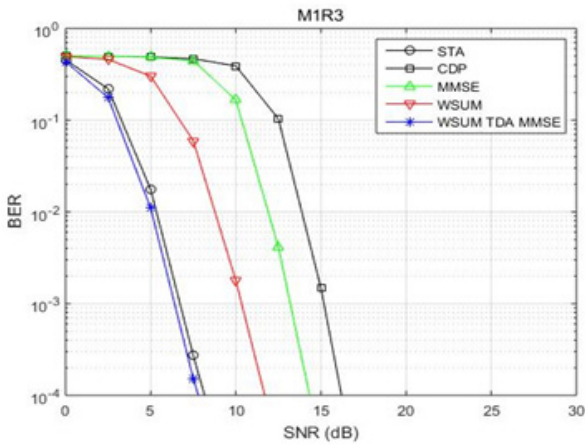

(a) Coded BER versus SNR (dB)

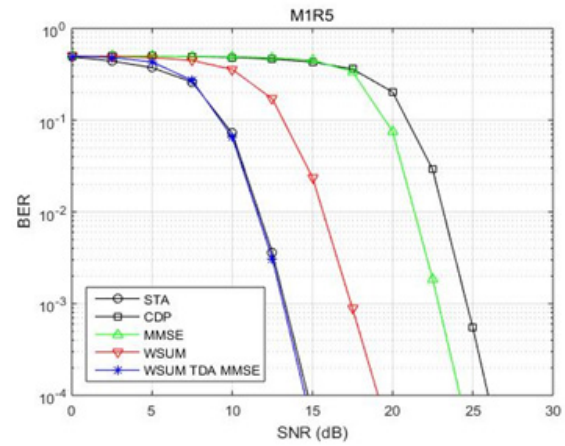

(a) Coded BER versus SNR (dB)

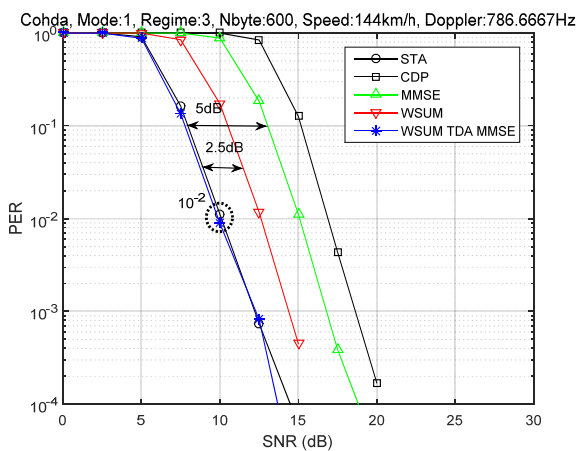

(b) PER versus SNR (dB)

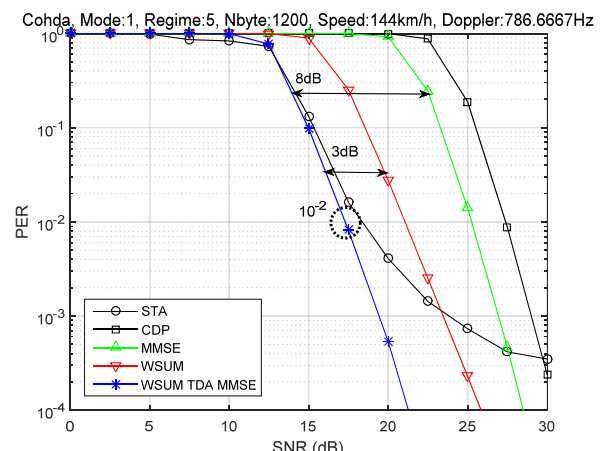

(b) PER versus SNR (dB)

Fig. 4. Error Performance Comparison with respect to Channel Estimation Schemes. (QPSK, Code Rate=1/2, Rural LOS, 144km/h)

Fig. 5. Error Performance Comparison with respect to Channel Estimation Schemes. (16QAM, Code Rate=1/2, Rural LOS, 144km/h)

Fig. 4 and Fig. 5 show coded bit error rate (BER) and packet error rate (PER) performance comparison with respect to channel estimation schemes under ‘Rural LOS with 144km/h’ for QPSK and 16QAM, respectively. Fig. 6 and Fig. 7 show BER and PER performance comparison with respect to channel estimation schemes under ‘Highway LOS with 252km/h’ for QPSK and 16QAM, respectively. In four figures, ‘WSUM TDA MMSE’ indicates the proposed scheme of subsection 4.1 with $[\omega_{-1}, \omega_0, \omega_1] = [0.5, 1.0, 0.5]$, $\beta = 1$, and $N = 2$.

From four figures, it is verified that the proposed scheme gives better error rate performance than the previous schemes at all SNR regions and regardless of modulation order (i.e., QPSK and 16QAM). It is shown from figures 5, 6, and 7 that ‘CDP’, ‘MMSE’, and ‘WSUM’ schemes can give the performance gain over ‘STA’ scheme at high SNR region but the performance gain of the proposed scheme can be obtained at all SNR regions. Therefore, the robustness of the proposed scheme is confirmed.

From Fig. 4, it is shown at 10^{-2} PER that the proposed scheme can give 2.5dB SNR gain over ‘WSUM’ and 5.0dB SNR gain over ‘MMSE’, respectively. In addition, from Fig. 5, we can see that those gains are increased for 16QAM. For Highway LOS environment, we can find same trend.

6. CONCLUSION

In this paper, we proposed the improved MMSE channel estimation scheme and its PER performance is verified by simulations. Furthermore, it is confirmed that the proposed one can outperform the conventional ‘STA’, ‘CDP’, ‘MMSE’, and ‘WSUM’ schemes at all SNR regions for both QPSK and 16QAM.

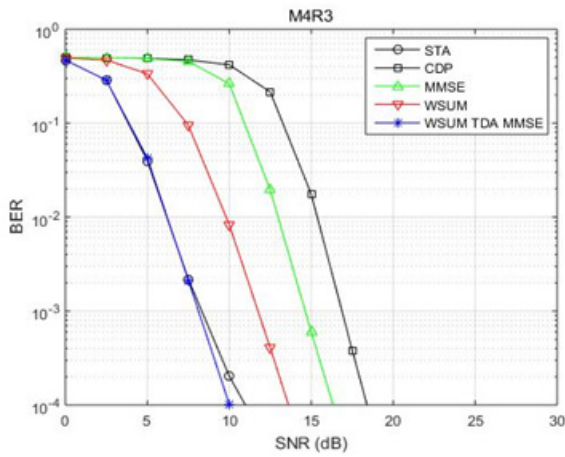

(a) Coded BER versus SNR (dB)

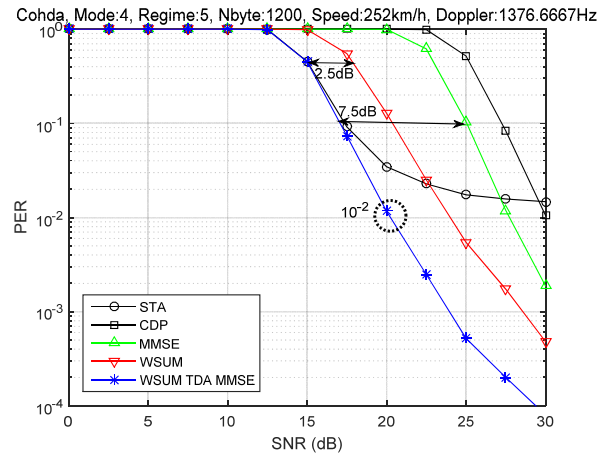

(b) PER versus SNR (dB)

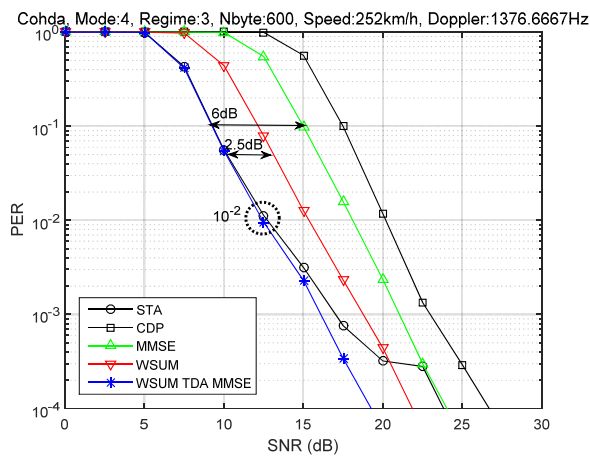

(b) PER versus SNR (dB)

Fig. 6. Error Performance Comparison with respect to Channel Estimation Schemes. (QPSK, Code Rate=1/2, Highway LOS, 252km/h)

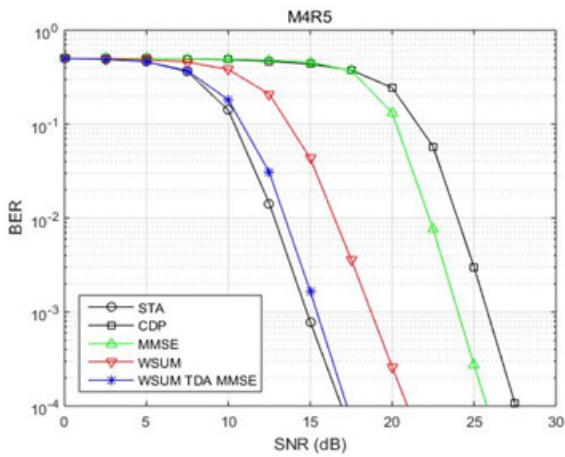

(a) Coded BER versus SNR (dB)

Fig. 7. Error Performance Comparison with respect to Channel Estimation Schemes. (16QAM, Code Rate=1/2, Highway LOS, 252km/h)

ACKNOWLEDGEMENT

The research was supported by a grant from the 2018 program for visiting professors overseas in Korea National University of Transportation.

REFERENCES

- [1] IEEE802.11p, IEEE Standard for Information Technology Telecommunication and Information Exchange Between Systems Local and Metropolitan Area Networks Specific Requirements. part 11: Wireless LAN MAC and PHY Specifications Amendment 6: Wireless Access in Vehicular Environments, 22 July 2014.
- [2] Malik Kahn, "IEEE 802.11 Regulatory SC DSRC Coexistence Tiger Team – V2V Radio Channel Models," Feb. 2014.
- [3] Sungmook Lim and Changick Song, "Iterative Channel Estimation Method to Enhance PER in V2V Communications Based on IEEE 802.11p," The Journal of Korean Institute of Information Technology, vol. 14, no. 12, Dec. 2016, pp. 79-88, doi: 10.14801/jkiit.2016.14.12.79
- [4] J. Zhao, X. Cheng, M. Wen, B. Jiao, and C. X. Wang, "Channel Estimation Schemes for IEEE 802.11p Standard," IEEE Intelligent Transportation Systems Magazine, vol. 5, no. 4, winter 2013, pp. 38-49, doi: 10.1109/MITS.2013.2270032
- [5] Yoon Kyeong Kim, Jang-Mi Oh, Yoo Ho Shin, and Cheol Mun, "Time and frequency domain channel estimation scheme for IEEE 802.11p," Intelligent Transportation Systems (ITSC), 2014 IEEE 17th International Conference on, 8-11 Oct. 2014, pp. 1085-1090, doi: 10.1109/ITSC.2014.6957832
- [6] J. Y. Choi, K. H. Yoo, and C. Mun, "MMSE Channel Estimation Scheme using Virtual Pilot Signal for IEEE 802.11p," Journal of Korean Institute of Information

Technology, vol. 14, no. 6, Jun. 2016, pp. 51-57, doi: 10.14801/jkit.2016.14.6.51

- [7] Joo-Young Choi, Cheol Mun, and Jong-Gwan Yook, "Adaptive Channel Estimation Based on a Decision Method Using a Long Preamble for the IEEE 802.11p," Proc. VTC2017-Spring, Sydney, Australia, 4-7 Jun. 2017, doi: 10.1109/VTCSpring.2017.8108356
- [8] Cho-Eun Park and Kyun-Byoung Ko, "Advanced Channel Estimation Schemes Using CDP based Updated Matrix for IEEE802.11p/WAVE Systems," International Journal of Contents, vol. 14, no. 1, Mar. 28, 2018, pp. 39-44, doi: <https://doi.org/10.5392/IJOC.2018.14.1.039>



DongSeon Jang

He received the B.S. and M.S. degrees in Department of Control and Instrumentation Engineering and Department of Information Technology Convergence at Korea National University of Transportation in 2016 and 2019, respectively. His current research

interests include wireless communications, cooperative relaying, and ITS.



Kyunbyoung Ko

He (corresponding author) received the B.S., M.S., and Ph.D. degrees in Electrical and Electronic Engineering at Yonsei University, Seoul, Korea in 1997, 1999, and 2004, respectively. From March 2004 to February 2007, he was a senior engineer in Samsung Electronics,

Suwon, Korea where he developed Mobile WiMAX systems for broadband wireless services. Since March 2007, he joined Korea National University of Transportation. From August 2018 to July 2019, he was a visiting scholar at Dept. of Electrical and Computer Engineering, Virginia Polytechnic Institute and State University. Currently, he is a Professor at Departments of electronics engineering and IT Convergence. His current research interests include the field of wireless communications focusing on multicarrier and multiantenna systems, cooperative relaying, and ITS.