

An Efficient Positioning Method for Multi-GNSS with Multi-SBAS

Kwi Woo Park¹, MinGyou Cho², Chansik Park^{1†}

¹Department of Electronics Engineering, Chungbuk National University/ Research Institute for Computer and Information Communication, Cheongju 28644, Korea

²Danam Systems Co.,Ltd, Anyang 13930, Korea

ABSTRACT

The current SBAS service does not provide a method to integrate multiple SBAS corrections. This paper proposes a positioning method to effectively integrate multiple SBAS and multiple GNSS. In the method, the final position is obtained by the weighted sum of the positions obtained from the combination of GNSS and SBAS. Since each position is independently computed and combined using flexible weights, it has a simple structure that can easily cope with various environments. In order to verify the operation and performance of the proposed method, raw measurements of GNSS and SBAS were collected using commercial receivers. The experiments using real signals show that the combined use of two SBAS corrections was more accurate by 0.05-0.4m(2dRMS) than using only one SBAS correction. To improve the position accuracy, this paper considered the integration of multi-GNSS and multi-SBAS, which was not found in other existing studies. The proposed method is expected to be a core technology for designing multi-GNSS navigation receivers considering multi-SBAS corrections. The importance of the method will be increased as KPS and KASS also available in near future.

Keywords: multi-SBAS, multi-GNSS, weighted sum, navigation solution

1. INTRODUCTION

The error of standalone Global Navigation Satellite System (GNSS) is several meters. Therefore, it is difficult to use for a precise positioning less than a meter, such as autonomous vehicles and precision mapping. In the aviation, besides accuracy and precision, availability and integrity are also strictly required. In order to satisfy these requirements, a Ground Based Augmentation System (GBAS) or Satellite Based Augmentation System (SBAS) is used to provide pseudo-range corrections and integrity information.

The SBAS is an augmentation system that transmits GNSS corrections and integrity information to a wide area using geostationary satellites. The SBAS provides fast correction and long-term correction to compensate for pseudo-range and satellite ephemeris, and ionospheric correction to

compensate ionospheric delay(ICAO 2006).

Currently, various GNSS such as GPS in the U.S., BDS in China, GLONASS in Russia, and Galileo in Europe are operating around the world. In addition, various SBAS are in operation around the world, such as Wide Area Augmentation System (WAAS) in the U.S., European Geostationary Navigation Overlay System (EGNOS) in Europe, MTSAT Satellite-based Augmentation System (MSAS) in Japan, GPS and GEO Augmented Navigation (GAGAN) in India, and System for Differential Correction and Monitoring (SDCM) in Russia (Lim et al. 2016). Korea also has a plan to build Korea Augmentation Satellite System (KASS) aiming at starting the operation in 2022 (Park et al. 2016).

MSAS and SDCM corrections are available in Korea (Lim et al. 2016). MSAS provides GPS corrections, and SDCM provides GPS and GLONASS corrections (Russian Space System 2012). Therefore, GPS has two corrections from MSAS and SDCM while GLONASS has one correction from GLONASS. The method to combine MSAS and SDCM corrections for GPS is required, however, there is no standard method to integrate and use multiple SBASs (ICAO 2006, Tsai

Received Aug 02, 2018 Revised Aug 20, 2018 Accepted Aug 29, 2018

†Corresponding Author

E-mail: chansp@cbnu.ac.kr

Tel: +82-43-261-3259 Fax: +82-43-268-2386

& Low 2014). The requirements of combining multi-SBAS corrections for multi-GNSS will be increased as the more GNSS and SBAS, such as Korean Positioning System (KPS) and KASS, are planned to deploy (GPSworld 2018).

Two studies on combining multiple SBAS corrections have been reported by Sakai et al. (2014) of the Electronic Navigation Research Institute (ENRI) in Japan and by Tsai & Low (2014) of Nanyang University in Singapore. Sakai et al. (2014) presented criteria for selecting appropriate ones from multiple SBAS corrections and compared the performance through experiments. Representatively, the elevation angle, protection level, number of satellites, and degradation of correction information were used as a criteria to select the corrections and the strengths and weaknesses of each selection were summarized. In this method, only one SBAS correction is selected by a criteria, the combination of multi-SBAS corrections is not considered.

On the other hand, Tsai & Low (2014) proposed a way to integrate and use multiple SBAS corrections. A weighted sum of each SBAS correction is computed and applied as a correction, where the weights are determined using fast and long-term degradation confidence, user ionospheric range error confidence, airborne receiver error confidence, and tropospheric error confidence. It demonstrated that integration of MSAS and GAGAN in Singapore can improve the accuracy. In this method, multiple SBAS corrections for a GNSS is considered, multiple GNSSs are not considered. To meet the requirement of the multiple GNSSs, the differences in time and coordinate system between GNSS systems should be considered. To the best of the authors' knowledge, no research has yet been performed to apply multiple SBAS corrections to multiple GNSSs.

This paper proposes a technique that can effectively obtain navigation solution using multiple GNSSs with multiple SBAS corrections. The weighting sum of positions obtained from each GNSS with each SBAS correction is determined as final solution, where the weights are used as appropriate design parameters. Since the implementation and tuning is very simple, the method can be easily applied to existing receivers without any changing of the receiver signal processing structure. The experiment was performed using various GNSS and SBAS combinations, and the results were compared and analyzed based on 2D accuracy and altitude accuracy.

This paper consists of 5 chapters. Chapter 2 describes the positioning process using a single GNSS with and a single SBAS correction. It includes a correction process and a description of the degradation factor to be used as weights. Chapter 3 describes the proposed positioning method using multiple GNSS with multiple SBAS corrections. The characteristics of the method is also given. Chapter 4

describes the experimental method and results using real signals obtained by the off-the-shelf commercial receivers. The experiment was performed using various GNSS and SBAS combinations, and the horizontal and vertical accuracy were compared and analyzed. The final chapter draws the conclusion.

2. SINGLE GNSS POSITIONING TECHNIQUE USING A SINGLE SBAS

2.1 The Correction Technique using SBAS

The position of the receiver is calculated by using GNSS satellite position and pseudo-range between the satellite and receiver. However, an error exists in the satellite position and atomic clock of the satellite included in the ephemeris. Besides, satellite position and clock error, the pseudo-range measurement includes clock error of the receiver, the ionospheric delay and tropospheric delay, and receiver noise. Even if the ephemeris includes the compensation information of satellite position, satellite clock error, and ionospheric delay, an error of several meters still occurs in the case of standalone GNSS (Jeong & Kim 2009).

The SBAS provides 3 types of corrections to the wide area DGPS using geostationary satellites to complement GNSS position accuracy and integrity performance. First, the fast correction can roughly compensate the errors contained in the pseudo-range. Since it is transmitted every 6 to 60 seconds, relatively quickly, it can be used immediately in the receiver. Second, long-term correction eliminates satellite position and satellite clock error more accurately than fast correction. This requires a relatively long time as correction information is transmitted every 120 seconds. Third, ionospheric correction provides ionospheric delay information for the service area. The receiver can eliminate the ionospheric errors included in pseudo-range by using ionosphere passage point of propagated wave and the surrounding ionospheric delay information. Fig. 1 shows the position calculation process using 3 corrections provided by SBAS.

In a SBAS, information necessary for calculating fast correction, long-term correction, and ionospheric correction is divided into some message types (MT) for transmission. The fast correction $\delta\rho$ can be calculated by Eqs. (1) and (2) using the Pseudo Range Correction (PRC) included in MT 2-5. The PRC transmitted from SBAS satellite is a correction value corresponding to the transmission time t_{off} and the Range Rate Correction (RRC) of Eq. (2) is used to convert it to correction value of current time t . The RRC refers to

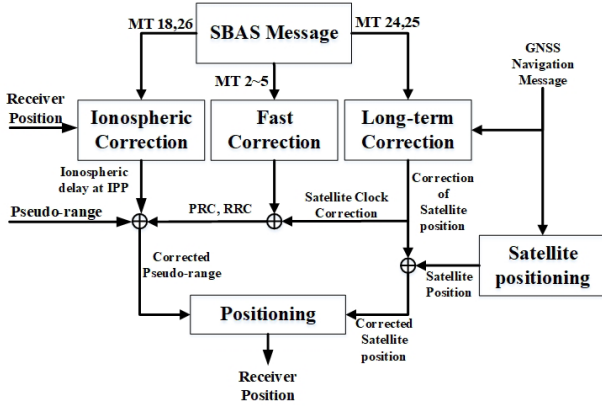

Fig. 1. A concept of SBAS based on measurements correction.

the amount of change in PRC during t_{of} and the previous transmission time $t_{of,previous}$. The position accuracy can be improved by adding the calculated $\delta\rho$ to the pseudo-range measurement.

$$\delta\rho(t) = PRC(t_{of}) + RRC(t_{of}) \cdot (t - t_{of}) \quad (1)$$

$$RRC(t_{of}) = \frac{PRC(t_{of}) - PRC(t_{of,previous})}{t_{of} - t_{of,previous}} \quad (2)$$

The long-term correction is calculated using MT 24 and 25, the coefficients for compensating satellite clock error δa_{f_0} and δa_{f_1} , time t_o , satellite position and velocity error, $[\delta x \ \delta y \ \delta z]^T$ and $[\delta \dot{x} \ \delta \dot{y} \ \delta \dot{z}]^T$. The satellite clock compensation value is calculated using Eq. (3), applying clock error change by the difference between the transmitted time t_o and current time t . $\delta a_{f_{G0}}$ is the time offset between GPS and GLONASS, it compensates the satellite clock including the fractional part value for GLONASS (Lim et al. 2016). The compensated satellite clock is used to improve pseudo-range and satellite position.

$$\delta \Delta t_{SV}(t) = \delta a_{f_0} + \delta a_{f_1}(t - t_o) + \delta a_{f_{G0}} \quad (3)$$

The satellite position correction value can be calculated using Eq. (4). The calculated satellite position error $[\delta \hat{x} \ \delta \hat{y} \ \delta \hat{z}]^T$ compensates satellite position computed using the ephemeris.

$$\begin{bmatrix} \delta \hat{x} \\ \delta \hat{y} \\ \delta \hat{z} \end{bmatrix} = \begin{bmatrix} \delta x \\ \delta y \\ \delta z \end{bmatrix} + \begin{bmatrix} \delta \dot{x} \\ \delta \dot{y} \\ \delta \dot{z} \end{bmatrix} (t - t_0) \quad (4)$$

It is difficult for SBAS to provide ionospheric delay values for all regions where receivers locate. Therefore, ionospheric correction defines the Ionospheric Grid Point (IGP), which divides the regions at regular intervals and provides

ionospheric delay value of the corresponding point. The ionospheric delay value of each IGP is included in MT 26 and the receiver must calculate latitude (ϕ_{pp}) and longitude (λ_{pp}) of the Ionospheric Pierce Point (IPP) to obtain ionospheric delay value of its location. Since elevation angle (E), azimuth (A), Earth's radius (R_e), and ionospheric height (h_i) are known, the earth-centered angle (ψ_{pp}) can be calculated by Eq. (5), and latitude of the IPP can be calculated by Eq. (6).

$$\psi_{pp} = \frac{\pi}{2} - E - \sin^{-1} \left(\frac{R_e}{R_e + h_i} \cos E \right) \quad (5)$$

$$\phi_{pp} = \sin^{-1} (\sin \phi_u \cos \psi_{pp} + \cos \phi_u \sin \psi_{pp} \cos A) \quad (6)$$

The longitude of the IPP (λ_{pp}) can be calculated with Eq. (7) using earth-centered angle (ψ_{pp}), the receiver's latitude (ϕ_u), and the receiver's longitude (λ_u).

$$\lambda_{pp} = \lambda_u + \pi - \sin^{-1} \left(\frac{\sin \psi_{pp} \sin A}{\cos \phi_u} \right) \quad (7)$$

When the IPP latitude and longitude are given, ionospheric delay value of the IPP point can be computed using ionospheric delay of the surrounding IGPs. Three or four IGPs may exist around the IPP, and the calculation method of ionospheric delay using three or four IGPs is found in RTCA_MOPS (2006). The standard SBAS does not provide tropospheric correction and it is independently compensated using the model at the receiver. The typical tropospheric correction models include the Saastamoinen model, the Hopfield model, and the Collins model, and this study applied the Collins model which is provided in the RTCA standard document (RTCA_MOPS 2006).

2.2 Integrity and Degradation Factors

In addition to corrections introduced in the previous section, a SBAS also provides integrity and degradation information of each corrections. Using this information, we can calculate the variance of fast correction and long-term correction (σ_{fl}^2) and the variance of ionospheric correction (σ_{UDRE}^2). The σ_{fl}^2 is calculated by Eq. (8) (Tsai & Low 2014). Where, is provided with the PRC from MT2-5, RSS_{UDRE} , ε_{fc} , ε_{rrc} , ε_{llc} , ε_{er} from MT 10, and $\delta UDRE$ from MT27.

$$\sigma_{fl}^2 = \begin{cases} [(\sigma_{UDRE}) \cdot (\delta UDRE) + \varepsilon_{fc} + \varepsilon_{rrc} + \varepsilon_{llc} + \varepsilon_{er}]^2 & RSS_{UDRE} = 0 \\ [(\sigma_{UDRE}) \cdot (\delta UDRE)]^2 + \varepsilon_{fc}^2 + \varepsilon_{rrc}^2 + \varepsilon_{llc}^2 + \varepsilon_{er}^2 & RSS_{UDRE} = 1 \end{cases} \quad (8)$$

The variance of ionospheric correction errors (σ_{UDRE}^2) can be calculated with Eq. (9) using the variance of ionospheric vertical delay errors of the IPP (σ_{UDRE}^2). Where, $F_{pp}(\theta_{EL})$ is the

obliquity factor which is calculated with Earth’s radius(R_e), ionospheric height (h_i), and elevation angle (θ_{EL}) (RTCA_MOPS 2006). Since the Earth radius and ionospheric height are constants, the obliquity factor can be defined as a function of elevation angle.

$$\sigma_{UIRE}^2 = F_{pp}^2(\theta_{EL}) \cdot \sigma_{UIVE}^2 = \left[1 - \left(\frac{R_e \cos \theta_{EL}}{R_e + h_i} \right)^2 \right]^{-1} \cdot \sigma_{UIVE}^2 \quad (9)$$

The SBAS provides the IGP ionospheric vertical delay accuracy indicator (σ_{GIVE}^2) and the performance degradation parameter of ionospheric compensation value (ϵ_{iono}). The pieces of data can be combined to calculate the variance of ionospheric vertical delay error for the IGP point (σ_{IGP}^2). The σ_{UIVE}^2 can be calculated using 3 or 4 σ_{IGP}^2 existing around the IPP. In this case, 3-4 values are combined using weights, which can be defined as a function of the positional relationship between the IGP and IPP (x_{pp}, y_{pp}). Calculating σ_{UIVE}^2 with σ_{IGP}^2 is as shown in Eq. (10) presented in RTCA_MOPS (2006).

$$\sigma_{UIVE}^2 = \sum_{n=1}^{3or4} [W_n(x_{pp}, y_{pp}) \cdot \sigma_{IGP,n}^2] \quad (10)$$

The variance of tropospheric delay compensation also varies according to elevation angle like ionospheric delay, and it is computed with Eq. (11) using $F_{pp}(\theta_{EL})$ (RTCA_MOPS 2006).

$$\sigma_{tropo}^2 = 0.12 F_{pp}^2(\theta_{EL}) \quad (11)$$

In this paper, the variance of SBAS correction errors (σ^2) is calculated as the sum of the 3 corrections as shown in Eq. (12), and it is used as the weight to obtain the position of the receiver.

$$\sigma^2 = \sigma_{fit}^2 + \sigma_{UIRE}^2 + \sigma_{tropo}^2 \quad (12)$$

2.3 Navigation Solution

This section describes the process of finding the position by applying obtained SBAS corrections to GNSS measurement. The Ψ in Fig. 2 is the ($L \times 1$) pseudo-range vector for L visible satellites measured from GNSS receiver. X is ($L \times 3$) GNSS satellite 3D position vector calculated by the ephemeris.

$\Delta\Psi$ denotes the ($L \times 1$) pseudo-range correction vector. It is the sum of corrections calculated using Eqs. (1, 3), ionospheric delay correction, and tropospheric delay correction. ΔX is ($L \times 3$) satellite position correction vector calculated by Eq. (4). W is a ($L \times L$) weighting matrix and

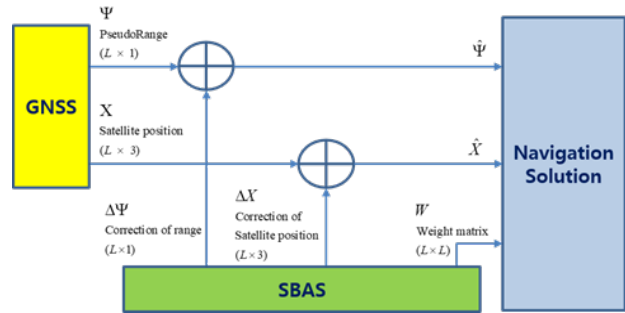

Fig. 2. A concept of a single SBAS single GNSS navigation.

is a diagonal matrix composed of the reciprocals of L degradation values obtained by Eq. (12). By combining GNSS measurements Ψ and X with SBAS corrections $\Delta\Psi$ and ΔX , the corrected pseudo-range $\hat{\Psi}$ and corrected satellite position \hat{X} can be obtained and these corrected pseudo-range and satellite position are used to calculate a design matrix H . The user position correction δP can be calculated through Eq. (13) applying the weighted least-squares method with the weighting W (Kaplan & Hegarty 2006).

$$\delta P = [H^T W^{-1} H]^{-1} H^T W^{-1} \delta \hat{\Psi} \quad (13)$$

where, the design matrix H is a ($L \times 4$) matrix composed of ($L \times 3$) LOS (Line of Sight) matrix and ($L \times 1$) vector with all 1 element. The ($L \times 1$) range error vector $\delta \hat{\Psi}$ is obtained by subtracting the computed distance between the initial user position P_0 and the satellite position from $\hat{\Psi}$. The position of the receiver P can be calculated by adding the calculated δP to P_0 .

3. A METHOD OF MULTI-GNSS POSITIONING WITH MULTI-SBAS

Currently, many GNSSs such as US GPS, Chinese BDS, Russian GLONASS, and European Galileo are operated. In addition, many SBASs such as US WAAS, European EGNOS, Japanese MSAS, Indian GAGAN, and Russian SDCM are under operation, and Korea has a plan of building KASS with the goal of operation in 2022. When multiple SBASs provide corrections, for a single GNSS multiple SBAS corrections may be provided. Thus, an efficient way to appropriately integrate these correction is necessary. This paper proposes an integration method that can effectively find the solution in a multi-GNSS environment with multi-SBAS corrections. For M SBAS and N GNSS, at first the proposed method finds M position solutions using a certain GNSS with M SBAS corrections. The same procedures are performed

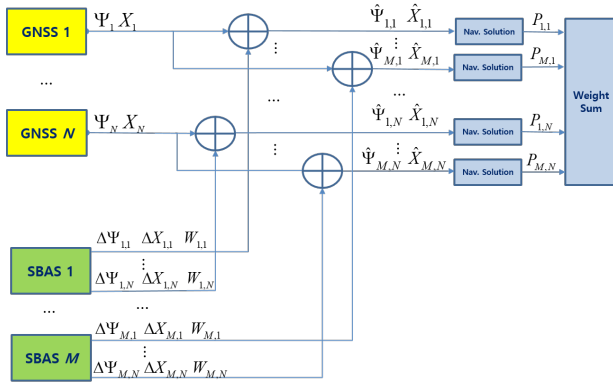

Fig. 3. A concept of multi-GNSS positioning with multi-SBAS.

for other N GNSSs to find total of MN position solutions. The final position is determined using a weighted sum of these MN positions. Details of the proposed method and its characteristics is given this chapter.

The method of estimating the position using N GNSSs and M SBASs is shown in Fig. 3. The n -th GNSS provides pseudo-range measurement vector Ψ_n and satellite position matrix X_n . To compensate measurements of the n -th GNSS, the m -th SBAS provides pseudo-range correction ($\Delta\Psi_{m,n}$), satellite position correction ($\Delta X_{m,n}$), and weight ($W_{m,n}$) calculated by the degradation factors. Even though the current SBAS does not provides corrections for all type of GNSS, in this paper, it assumed that a SBAS provides corrections for all GNSSs. It is strongly expected that most SBAS will provides multi-band, multi-constellation corrections in near future and if there are no corrections for certain GNSSs, by resetting the weighting as zero, they can be easily removed. The positioning equations using *one* GNSS (where L satellites are visible) and *one* SBAS correction is described in Section 2.3.

For N GNSSs and M SBAS, MN positional results $\{P_{1,1}, \dots, P_{M,N}\}$ can be obtained. If less than 3 satellites are visible for a certain GNSS, it is not possible to find a 3D position. In this case, the GNSS is excluded from final solution computation by resetting the weighting. The calculated positions are integrated into a final solution using the weighting $\alpha_{m,n}$. The weighting can be used as design parameters. It can be appropriate value, for example if there is no SBAS correction or no position solution since number of visible satellites are less than 3, then it is set to zero. If all weightings are set as 1, the final position is average of all positions.

It is well known that Dilution of Precision (DOP) indicates the precision of solution and is function of geometry and number of visible satellites. And the service range of a SBAS is limited and it is expected that the closer service range, the better performance expected, and vice versa. Therefore, DOP, number of satellites, and service range of SBAS can be

an alternative weighting since the geometry and number of satellites are different to each N GNSSs. Using the proper weightings and multiple positions $P_{m,n}$, $m=1, \dots, M$, $n=1, \dots, N$, a single final position P can be obtained.

$$P = \frac{1}{\sum_{n=1}^N \sum_{m=1}^M \alpha_{m,n}} \sum_{n=1}^N \sum_{m=1}^M \alpha_{m,n} P_{m,n} \quad (14)$$

In the Tsai & Low (2014) method a weighted correction is obtained by combining multiple SBAS corrections, and it is applied to a GNSS. Note a satellite without SBAS correction is usually excluded to find solution or it has very small weighting not to affect performance. Since the number of weighted correction is larger than each SBAS correction, the probability of having SBAS correction increases and in turn, the availability is increased.

Tsai & Low (2014) do not provide the method for multi-GNSS, but if we expand their method, the probability of having sufficient satellites for navigation is increased and it improves the availability. On the other hand, the proposed method uses each SBAS correction only and the number of visible satellites is not changed. It implies that there is the possibility of not to find position because of lack of visible satellites. However, this is very trivial problem since the satellites without SBAS correction can be used to find solution by controlling weighting, and as the rapid growth of GNSS and SBAS, sufficient number of satellites and corrections will be guaranteed to find positions at all times.

By the way, In the Tsai & Low (2014) method, the requirement to compensating time and coordinate system between different GNSSs is not easy. In other words, the structure of the receiver will become more complex, so the structure of the conventional off-the-shelf receiver have to change significantly. On the other hand, the proposed method is applicable even if the time is different, because each system finds the position independently using their own time and coordinate system

4. EXPERIMENTS AND PERFORMANCE ANALYSIS

4.1 Experimental method and environment

In order to verify the performance of the proposed method, raw measurements of GNSSs and SBAS are gathered using commercial off-the-shelf receivers and the positioning results are compared using navigation program implemented with MATLAB. The NovAtel 702-GGL antenna (NovAtel

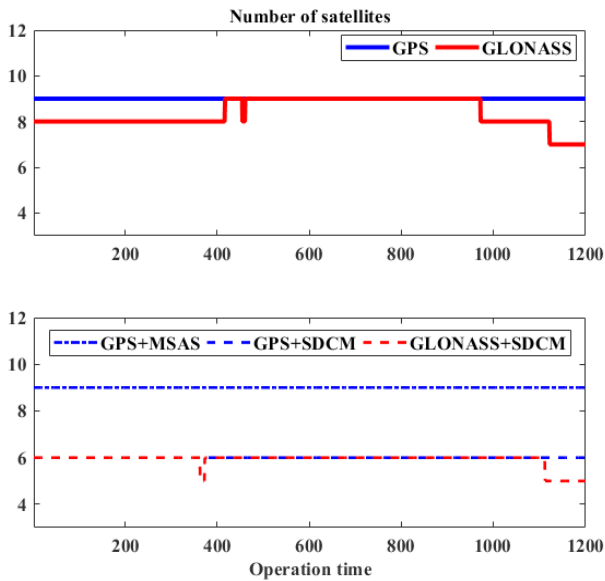

Fig. 4. Number of GNSS satellites and corrections from SBAS.

2013) and the Ublox EVK-M8T receiver (Ublox 2016) which provides raw data such as GNSS pseudo-range, navigation message, reception status, and SBAS message, was used to gather measurements. The Ublox receiver provides the raw data at 1Hz and is stored on PC. The positions from various combinations of GNSSs and SBASs are obtained using the stored data. The weighted least squares method with the measurements of an elevation angle of more than 5 degrees and a C/N0 greater than 30 dB/Hz was used to estimate a GNSS position. The position accuracy was evaluated using the precise reference position measured by the JAVAD DELTA receiver which uses Network RTK (JAVAD GNSS 2009).

The raw measurements of GPS, GLONASS, MSAS, and SDCM were collected using the EVK-M8T receiver for 20 minutes from 13:10 on December 26, 2017 at Chungbuk National University, Cheongju, Korea. The upper figure in Fig. 4 shows the number of GPS and GLONASS satellites. The lower figure shows the number of GNSS with SBAS corrections, where among 10 GPS satellites, 9 satellites corrections from MSAS are valid. And only 6 GPS satellites corrections and 5~6 GLONASS corrections from SDCM are valid. On average, 9 GPS satellites and 8.3 GLONASS satellites were received. At this time, 9 GPS satellites correction data from MSAS are acquired, equal to the number of satellites received. On the other hand, there were only 6 GPS satellites correction data received from SDCM. GLONASS correction data received only 5~6 satellites of approximately 8 satellites.

Compared with Fig.3, GPS and GLONASS are GNSS1 and GNSS2. And MSAS and SDCM corrections are SBAS1 and SBAS2. Since MSAS provides GPS correction only, 3

Table 1. Possible combination of multi-GNSS positioning with multi-SBAS.

No.	$\alpha_{1,1}$	$\alpha_{2,1}$	$\alpha_{2,2}$	Combination of GNSS and SBAS
1	1	0	0	GPS+MSAS
2	0	1	0	GPS+SDCM
3	0	0	1	GLONASS+SDCM
4	1	1	0	(GPS+MSAS)+(GPS+SDCM)
5	0	1	1	(GPS+SDCM)+(GLONASS+SDCM)
6	1	0	1	(GPS+MSAS)+(GLONASS+SDCM)
7	1	1	1	(GPS+MSAS)+(GPS+SDCM)+(GLONASS+SDCM)

Table 2. Positioning accuracy of combination No. 1, 4 and GPS.

	2D accuracy (m)	Altitude accuracy (m)
GPS	1.655	4.198
No. 1	1.106	1.124
No. 4	1.049	0.411

navigation solutions ($P_{1,1}$, $P_{2,1}$, $P_{2,2}$) are obtained excluding $P_{1,2}$. As shown in Table 1, 7 combinations are possible by combining the 3 navigation solutions using the proper weights. Note $\alpha_{1,2}$ is always 0 since no SBAS1 correction for GNSS2.

The proposed method combines the positions calculated independently by each combination, therefore, designer does not have to consider the difference of number of satellites of each combination. The experiment estimates the position using only satellites that provide correction values.

4.2 Experimental results and analysis

In order to confirm the effects and analyze the characteristics of the proposed method, the positions obtained in various combinations are compared.

First, in order to confirm the performance of single GNSS with multi-SBAS corrections, the GPS position with MSAS and SDCM was obtained and analyzed. The results are summarized in Figs. 5 and 6 and Table 2, where scenario No. 1 is the result of GPS with MSAS, and No. 4 is the result of GPS with MSAS and SDCM. The entire scenario can be found in Table 1. The position from standalone GPS and the JAVAD receiver are recorded for reference.

Figs. 5 and 6 shows 2D horizontal and vertical accuracy of each combination. The green dot is the reference position obtained by the JAVAD receiver. This position is regarded as true and the position error is the difference between true position and computed position under consideration. The standalone GPS position error are shown in black dots, GPS position error with MSAS correction (No. 1) in red dots, and GPS position error with MSAS and SDCM corrections (No. 4) in blue dots. The circles represent precision with radius of 2dRMS values calculated using 1200 position errors. Fig. 6 shows the vertical errors of three combinations. The solid line indicates the average error of each case.

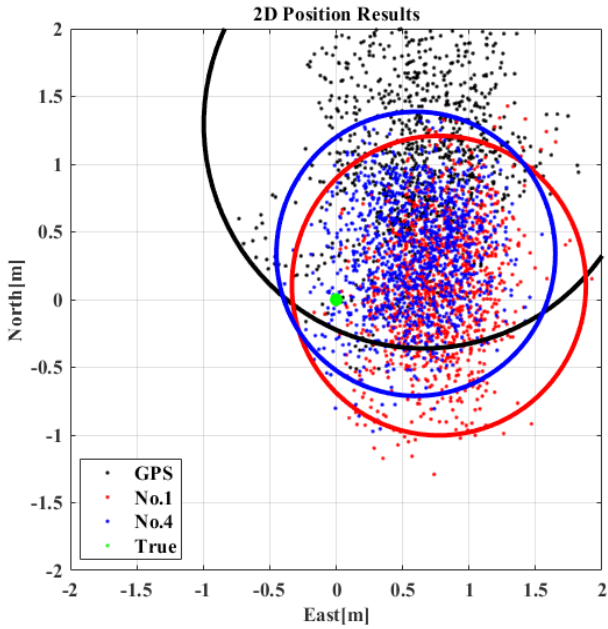

Fig. 5. 2D position error of combination No. 1, 4 and GPS.

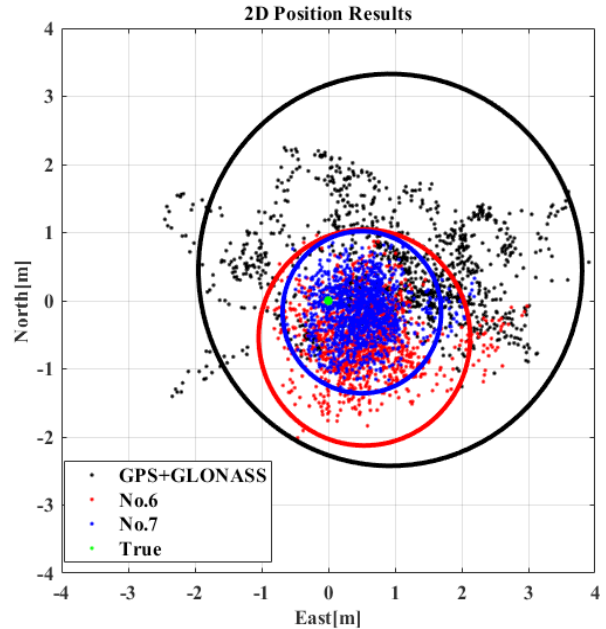

Fig. 7. 2D position error of combination No. 6, 7 and GPS+GLONASS.

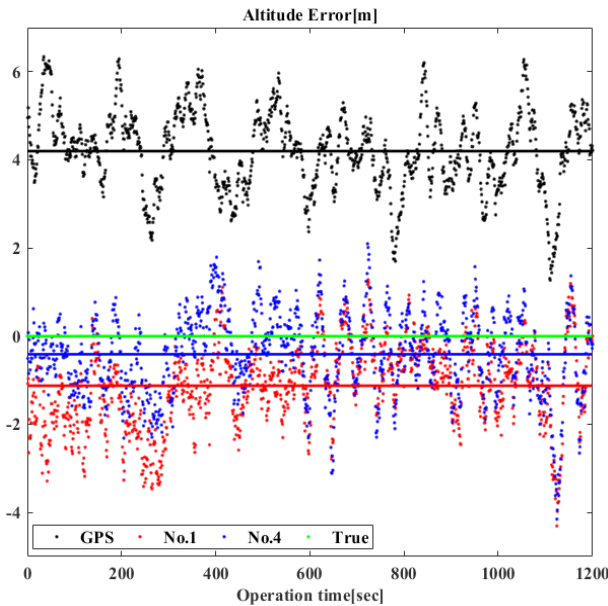

Fig. 6. Height error of combination No. 1, 4 and GPS.

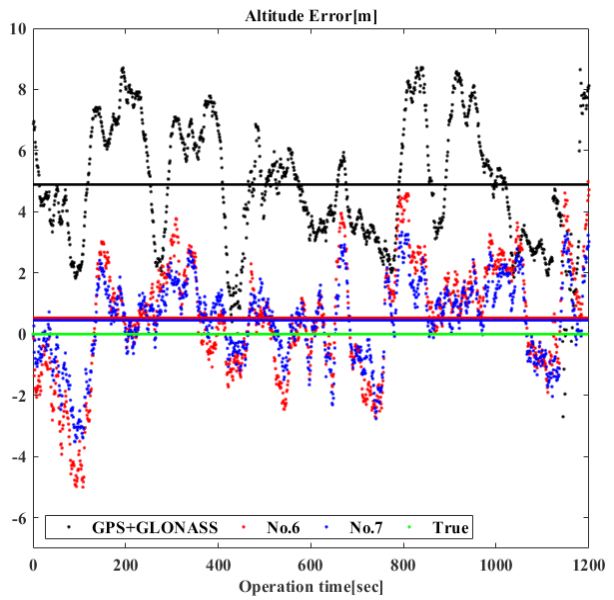

Fig. 8. Height error of combination No. 6, 7 and GPS+GLONASS.

Table 2 shows that by using SBAS corrections more than 0.5 m accuracy improvement is achieved. In particular, in the altitude, more than 3 m improvement is observed. Compared to No. 1, No.4 shows about 0.05 m accuracy improvement. In terms of altitude, No. 4 gives about 0.6 m accuracy improvement. Note that when correcting GPS with SDCM corrections, the number of satellites is reduced to 6 because the correction of 3 satellites (PRN No. 5, 24, 28) are not provided by SDCM while it is visible in far-east Korean region. Small number of visible satellites reduces PDOP,

Table 3. Positioning accuracy of combination No. 6, 7 and GPS+GLONASS.

	2D accuracy (m)	Altitude accuracy (m)
GPS+GLONASS	2.877	4.892
No. 6	1.585	0.532
No. 7	1.189	0.455

nevertheless, the result of using MSAS and SDCM corrections shows performance improvement.

In second experiment, the performance of the proposed method using multi-GNSS with multi-SBAS corrections is

evaluated. Two scenarios, No. 6 and No. 7, are considered. No. 6 is a combination of GPS position with MSAS correction and GLONASS position with SDCM correction. No. 7 combines GPS position with SDCM correction and the result of No. 6. Figs. 7 and 8 and Table 3 summarized the results.

Figs. 7 and 8 shows 2D horizontal and vertical accuracy of each combination. The results using GPS and GLONASS without SBAS corrections are expressed in black dots. The red dots are the result of using GPS and GLONASS with MSAS and SDCM corrections (No. 6). The blue dots are the result of using GPS with MSAS correction, GPS with SDCM correction, and GLONASS with SDCM correction (No. 7). The circles represent precision with radius of 2dRMS values calculated using 1200 position errors. Fig. 8 shows the vertical errors of three combinations. The solid line indicates the average error of each case.

As with single GNSS, multiple GNSS with SBAS corrections gives more accurate results. Table 3 shows that 2D horizontal accuracy improvement of 1.3 m (2dRMS) is obtained by using SBAS compared to standalone GPS and GLONASS positioning. The vertical accuracy is improved by 4.3 m when using SBAS corrections. By comparing No. 6 and 7, the more SBAS corrections, the better accuracy obtained. The horizontal and vertical accuracy of No. 7 is about 0.4 m and 0.07 m is improved by adding GPS with SDCM correction to No. 6. By using multiple SBAS corrections rather than single SBAS correction, the more accurate results are obtained. This experiment shows that the more GNSS and SBAS corrections, the better results are expected

It is remarkable that by adding GLONASS the performance is degraded as shown Table 2 and 3. The experiments shows 2D horizontal accuracy of standalone GLONASS and GLONASS with SDCM correction is 5.5 m (2dRMS) and 3.0 m (2dRMS), respectively. The position accuracy of GLONASS is three times worse than that of GPS. Therefore, the result of the proposed method where every positions are combined as a weighted sum, will rather be degraded by adding GLONASS. This result implies that adequate weighting selection methods are needed where the performance of each GNSS are properly considered. In future, research should be performed on weighting selection methods using GNSS and SBAS information such as PDOP, satellite signal reception status, and the accuracy of known systems.

5. CONCLUSIONS

Multiple SBAS signals will exist when KASS of Korea is operational in 2022, but there are no standards for applying multi-SBAS yet. In particular, multi-GNSS environments are

not considered. This paper proposed an efficient positioning method using multi-GNSS with multi-SBAS corrections. The method can be easily applied without any changing of the structure of the receiver. Since the weight of the proposed method can be used as appropriate design parameters, it is easy to implement and flexible to apply in a multi-constellation environment. It is also simple because there is no need to compensate for the differences in time and coordinate system between each GNSSs.

In order to verify the operation and performance of the proposed method, raw measurements of GPS, GLONASS, MSAS, and SDCM using off-the-shelf commercial receivers are collected and processed by the implemented algorithm using MATLAB. The experiments show that, in the horizontal plane, the combined use of two SBAS corrections was more accurate by 0.05-0.4 m (2dRMS) than using only one SBAS correction, while in the vertical plane by 0.07-0.7 m. The proposed method is expected to be a core technology for designing multi-GNSS navigation receivers considering multi-SBAS corrections. The importance of the method will be increased as KPS and KASS also available in near future.

REFERENCES

- GPSworld, Korea will launch its own satellite positioning system [Internet], cited 2018 Oct 08, available from: <http://gpsworld.com/korea-will-launch-its-own-satellite-positioning-system/>
- ICAO 2006, International Standards and Recommended Practices (SARPs): Aeronautical Telecommunications, Annex 10, vol.1, 6th edition. http://web.tuke.sk/lf-klp/Durco%20Stanislav/LP%20II/LITERATURA/Annex10_Vol1_2007-org.pdf
- JAVAD GNSS 2009, JAVAD DELTA GNSS Receiver Operator's Manual Version 1.4, <http://gnss.lt/saugykla/javad/Delta/delta-operators-manual-090504.pdf>
- Jeong, M.-S. & Kim, J.-R. 2009, Analysis of MSAS correction information and performance in Korea, *Journal of the Korean Society for Aeronautical & Space Sciences*, 37, 372-382
- Kaplan, E. D. & Hegarty, C. J. 2006, *Understanding GPS: Principles and Applications*, 2nd ed. (Boston: Artech House Inc.)
- Lim, C.-S., Park, B., So, H., Jang, J., Seo, S., et al. 2016, Analysis on the Multi-Constellation SBAS Performance of SDCM in Korea, *JPNT*, 5, 181-191, <http://doi.org/10.11003/JPNT.2016.5.4.181>
- NovAtel 2013, GPS-701-GGL and GPS-702-GGL USERGUIDE, OM-20000117. <http://www.novatel.com/assets/>

Documents/Manuals/om-20000117.pdf

Park, J.-I., Lee, E., Heo, M.-B., & Nam, G. 2016, Latest Technology Trending for Satellite Based Augmentation System, Current Industrial and Technological Trends in Aerospace, 14, 191-202

RTCA-MOPS, 2006, Minimum Operational Performance Standards for Global Positioning System / Wide Area Augmentation System Airborne Equipment, RTCA document 229-c. <https://standards.globalspec.com/std/1014192/rtca-do-229>

Russian Space System 2012, Radiosignals and digital data structure of GLONAS Wide Area Augmentation System, System of Differential Correction Monitoring, Interface Control Document, 2012. http://www.sdcm.ru/smglo/ICD_SDCM_1dot0_Eng.pdf

Sakai, T., Hoshinoo, K., & Ito, K. 2014, SBAS Satellite Selection and Performance Monitoring at the Region Where Multiple SBAS are Available, in ION GNSS+ 2014, 8-12 Sep. 2014, Tampa, Florida, pp.3331-3342.

Tsai, Y.-F. & Low, K.-S., 2014, Performance assessment on expanding SBAS service areas of GAGAN and MSAS to Singapore region, in Position, Location and Navigation Symposium-PLANS 2014, 5-8 May. 2014, Monterey, CA. <http://doi.org/10.1109/PLANS.2014.6851433>

Ublox 2016, NEO/LEA-M8T u-blox M8 concurrent GNSS timing modules data sheet, UBX-14006196-R06. https://www.u-blox.com/sites/default/files/NEO-LEA-M8T-FW3_DataSheet_%28UBX-15025193%29.pdf



Chansik Park received his B.S., M.S., and Ph.D. degrees in Electrical Engineering from National University in 1984, 1986 and 1997, respectively. He was a Professor with the School Electronics Engineering, Chungbuk National University, Cheongju, Korea, since 1997. His research interests include GNSS, PNS, SDR, integer ambiguity resolution algorithm and Error Analysis.



Kwi Woo Park received his B.S. and M.S. degrees from Chungbuk National University, Korea in 2013 and 2015, respectively. He is currently a Ph.D. candidate in Department of Control and Robotics Engineering at the same university. His research interests include GNSS signal processing, SDR and navigation.



MinGyou Cho received his B.S. degree in Department of Electronic Engineering from Chungbuk National University. He is a M.S. candidate in the Department of Control and Robotics Engineering at Chungbuk National University in Korea. His research interests include multi-constellation Attitude Determine and Heave estimation.