

Status and Prospect of Test Methods of Quality Silicone Water Repellent for Protecting Reinforced Concrete

H. Y. Sun^{1,3,†}, Z. Y. Yuan^{1,2}, Z. Yang^{1,3}, G. L. Shan^{1,3}, and M. X. Shen²

¹Nanjing Hydraulic Research Institute, Nanjing 210029, Jiangsu, China

²College of Mechanics and Material, Hehai University, Nanjing 210098, Jiangsu, China

³State Key Laboratory of Hydrology-Water Resources and Hydraulic Engineering, Nanjing 210029, Jiangsu, China

(Received February 08, 2017; Revised April 28, 2017; Accepted May 02, 2017)

Impregnating with quality silicone water repellent on the concrete surface is an effective method of protecting concrete. Quality silicone water repellent has been widely used in the engineering profession because of its desirable properties such as hydrophobicity, keeping concrete breathable and preserving the original appearance of the concrete. The companies in China that produce silicone water repellent are listed. Test methods in the specifications or standards about silicone water repellent in China are summed. The test methods relative to durability of concrete impregnated with silicone water repellent (such as resistant to chloride ion penetration, resistant to alkali, resistance to freezing and thawing and weatherability etc.) and the constructive quality (such as water absorption rate, impregnating depth and the dry velocity coefficient etc.) are compared and analyzed. The results indicate that there are differences among test methods relative to different specifications with the same index and therefore, confusion has ensued when selecting test methods. All test methods with the exception of the method of water absorption rate by using a Karsten flask are not non-destructive methods or conducted in a laboratory. Finally, further research on silicone water repellent during application is proposed.

Keywords: silicone water repellent, reinforced concrete, specification, anticorrosion, silane

1. Introduction

If not protected, the reinforced concrete in corrosion environment may be corroded. The corrosion may affect the safe running of the structures and may shorten the service life of structures. The methods to improve the durability of reinforced concrete are to use high performance concrete, corrosion inhibitor admixed in concrete, anti-corrosion coatings on concrete surface, rebar coated with epoxy resin powder coating, controlled permeability formwork liner during construction, cementitious capillary crystalline materials, electrochemical protection and silicone water repellent (hereinafter referred to as SWR) coated on concrete surface, etc.. SWRs have been widely used in harbour, bridge, water resources engineering and so on. There is not a uniform standard to specify the test methods of properties of concrete impregnated with silicone water repellent, such as the SWR product performance, durability and construction properties of concrete.

2. The SWR Products

The varieties of SWR widely used by now include the methyl silicate, alkyl alkoxy silane, siloxane, silane oligomers and silane/siloxane mixture, which are 100% pure product, emulsion, paste or creme and products diluted with organic solvent. Several years ago the silane used on the reinforced concrete surface are mainly from foreign companies, such as Wacker Chemie BS® 1701, BS® 290 and BS® Creme C, Dow Corning® Z-6403, Z-6341 and 520 silane emulsion and Degussa TEGOSIVIN® HE328, HE 860 and HE Creme 800 etc.. The SWRs can be produced in China now, but the scale and yield of domestic companies is smaller than that of foreign companies. The Chinese companies and their products are listed in Table 1.

3. The Principle of SWR for Protecting Reinforced Concrete

Using SWRs is one of protection methods of reinforced concrete. While applied on the concrete surface, the differences between waterproof coatings (Fig. 1a & 1b) and SWRs (Fig. 1c) are as follow: the coatings will completely

[†] Corresponding author: rehaaha@163.com

Table 1 The companies and products of silicone water repellent in China

Company name	Product variety
Wuhan Daoer Chemical-industry Co.,Ltd (http://www.daoerchem.com)	DB-H538 isobutyl triethoxysilane, DB-H580silane creme, DR-506 isooctyl triethoxysilane, DR-H520 silane/siloxane emulsion, dodecyl triethoxysilane, methyl silicate etc.
Nanjing Hydraulic Research Inst.[1,2] (http://www.nhri.cn)	GM901 multifunctional protection silicone, YJG silane oligomer
Quanzhou Sikang New Materials Co.,Ltd (http://www.sicongprotect.com)	SP-603 silane creme, SP-205 isobutyl triethoxysilane, SP-206 isooctyl triethoxysilane, SP-207 dodecyl triethoxysilane
Zhangjiagang Guotai-Huarong New Chemical Materials Co., Ltd [3,4] (http://www.gthr.com.cn)	WRG octyl silane creme, WRL octyl silane, WRE silane/siloxane emulsion, SCA series of alkyl alkoxy silanes
Nanjing Chengong silicone Co., Ltd (http://www.njcghg.com)	isobutyl silane, octyl silane, dodecyl silane, cetyl silane
Qingdao Runbang Chemical Building-materials Co., Ltd (http://www.runbang.cn)	RBS-1500 capillary crystalline silane waterproof and anti-corrosion agent, isobutyl triethoxysilane
Shanghai Municipal Engineering Design Institute Co., Ltd[5] (http://www.smedi.com)	SK-220 isooctyl triethoxysilane

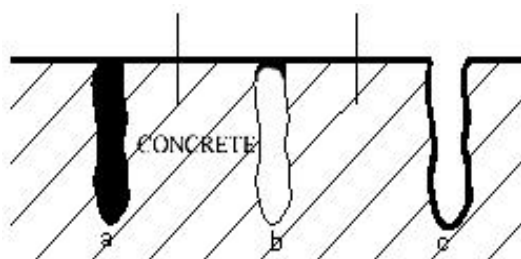
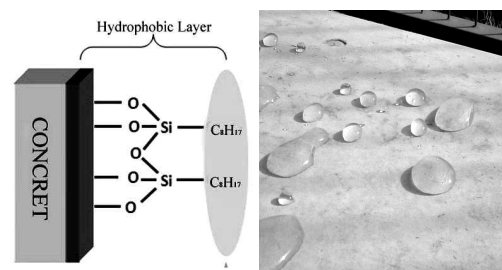
**Fig. 1** Three measures to protect concrete.**Fig. 2** The protection principle of water repellent.

isolated concrete from the environment by clogging pores (Fig. 1a) or closing the pores on the surface (Fig. 1b); by the permeable performance of concrete, the SWRs can permeate into a certain depth of concrete, form hydrophobic layer and keep the respiratory function of concrete without clogging the pores of concrete (Fig. 1c). The bubbling and cracking does not occur while using SWRs because it cannot form film unlike the other film-forming coatings. The protection principle of silicone water repellent is shown in Fig. 2.

4. The Specifications or Standards about SWRs

There are many standards about SWRs applied on concrete. In abroad, they are the UK Highways Agency standards (BD43/03) [6], European standard EN1504-2-2004

[7], American Concrete Institute ACI 546R [8] and International Concrete Repair Institute ICRI 03732 [9].

The application and research of SWRs were started from 1990s in China. The first specification including SWRs was JTJ275-2000 [10] which was released by the Ministry of Transportation of China. Then other standards including SWRs were released in China, such as JTG/T B07-01-2006 [11], JG/T 337-2011 [12], CCES 01-2004 [13], TB 10005-2010 [14] and TB/T 3228-2010 [15].

5. The Test Methods about SWRs in Specifications

The requirements about SWRs in these specifications are shown in Table 2.

In Table 2, the freezing and thawing resistance, the resistance to UV aging and the resistance to chloride pene-

Table 2 The requirements about SWR in specifications

Performance index		JTJ 275	JTG/T B07-01 BD 43/03 EN 1504-2	TB/T 3228	JG/T 337 ^a
Water absorption rate[mm/min ^{1/2}]		<0.01			
Water absorption ratio[%]			<7.5	<7.5	≤10
Water absorption ratio after exposure to alkali[%]			<10 ^b	<10	≤12
Impregnation depth in concrete [mm]	≤C45	3-4	3-4	<C40, 4-10	
	> C45	2-3	2-3	C40, ≥1-4	
	W/C=0.70		10		W/C=0.6, ≥6
Rate of resistance to chloride penetration[%]		≥90		>80	≤7mm ^c
Drying rate coefficient[%]			>30	≥30	
Freezing and thawing resistance (comparing with normal concrete in salt solution)			20 times cycling more ^d	W/C=0.70 : 15 times cycling more	
Resistance to UV aging [%](water absorption rate after 1000h UV radiation)					≤10

a. Chloride environments; b. the index is not in EN1504-2; c. the chloride ion penetration depth; d. the index is not in BD 43/03 and EN 1504-2

Table 3 The property indexes of SWRs from 3 foreign companies

category	model	appearance	active principle /%	density /g/cm ³	viscosity	pH	flash point/°C
100% SWR	Wacker BS 1701	Colorless or light yellow	99	0.90	1.90mm ² /s		70
	Dow corning 6341		98	0.88		63	
	Tegosivin HL 250		100	1.03	10-20mPa·s	>80	
emulsion	Wacker BS 45	Milky white	50	1.04	1000mPa·s	5	
	Dow corning 520		40	0.985		4.5	>100
	Tegosivin HE 328		50±2	1.0	40-55s ^a		
creme	Wacker BS creme C	White paste	80	0.90		6	74
	Tegosivin HP 800		80	0.90			
	Chinese standard ^b			0.9±0.1		7±1	
Test method		Visual inspection	Gas chromatography	GB/T611-2006		GB/T8077-2012	GB/T 261-2008

a ISO cup (3mm/23°C), b. The requirement of chloride ion content is ≤50mg/L in the standard JT/T991-2015 “Silane Paste Coating Material for Surface Protection of Bridge Concrete Structure”

tration are the durability of concrete. On site, these parameters including water absorption rate or water absorption ratio, impregnation depth, dry velocity coefficient, hydrophobicity and resistance to chloride penetration are the main properties of controlling quality. But there is not requirement about the resistant to salt fog and the resistant to carbonation about SWRs in these specifications.

5.1 The product indexes of SWR

The SWRs have 100% pure product, emulsion, paste or creme and products diluted with organic solvent. The index of different products may be different. The indexes of several products from 3 companies which are Wacker Chemie Co., Dow Corning Co. and Degussa Co. are listed in Table 3.

From Table 3, it indicates that the difference may exist in the same category product of different company and the property may also be difference.

5.2 The durability of reinforced concrete impregnated with SWR

The durability of reinforced concrete impregnated with SWR includes these properties such as resistant to chloride ion penetration, resistant to alkali, resistant to freezing and thawing, resistant to carbonation and resistant to UV aging etc.. The properties of the resistant to alkali and the resistant to UV aging are used to determine the property of SWR. There is not a specification including the test of the property of resistant to carbonation of concrete impregnated with SWRs by now.

5.2.1 The property of the resistant to chloride ion penetration of the concrete impregnated with SWRs

The property of resistant to chloride ion penetration can be expressed with the rate of resistance to chloride penetration and the Cl^- penetrating depth. The property of resistant to Cl^- is tested with the method of DC electrical penetration in JTJ275 [10] and JTJ/T B07-01 [11]. The test methods of resistant to Cl^- are introduced as follow.

(1) The rate of resistance to chloride penetration

The rate of resistant to Cl^- penetration is $\geq 90\text{wt}\%$ in JTJ275 [10] and $> 80\text{wt}\%$ in TB/T 3228 [15]. The test method is as follow. Six test cubes (three treated and three untreated) shall be cast with water-cement ratio of 0.45 and cured for 28 days in standard condition. No oil or release agent shall be permitted on the surface. The solvent-free epoxy resin coating shall be used to seal other faces and the region with less than 5mm width from edge of original test face of the cube. The treated cubes shall be conditioned on a bench in the laboratory (temperature $(21\pm 2)^\circ\text{C}$ and relative humidity $(60\pm 10)\%$) for 7 days. The

treated face shall be put facedown into the 5 mol NaCl solution ($(23\pm 2)^\circ\text{C}$) and kept in solution with immersion liquid 10mm height from treated face and then be removed after 24 hours. Then the test cubes shall be dried at 40°C in oven for 24 hours and the 2mm piece that is cut from treated face must be discarded. Then the test samples which shall be powdered are obtained by cutting test cube according 0 ~ 10 mm, 11 ~ 20 mm, 21 ~ 30 mm from the treated face. The chloride content of concrete can be measured and the rate of resistant to Cl^- penetration can be calculated as equation $\Delta CU = (CU - CU_1)/CU$, where: ΔCU is the rate of resistant to Cl^- penetration, CU is the mean chloride ion content of these samples of the untreated cubes at 3 different depths and CU_1 is the mean chloride ion content of these samples of the treated cubes at 3 different depths.

(2) The Cl^- penetration depth

The content of Cl^- at different depth is used to express the Cl^- penetration depth in JG/T 337 [12]. Except the treated face and its opposite face of the test cube the other 4 faces shall be sealed with solvent-free epoxy resin coating. 3 test cubes shall be impregnated with SWR. The test cubes which are dried at 50°C for 48h in the oven shall be removed and be conditioned to the room temperature at $(20\pm 2)^\circ\text{C}$ and $\text{RH}(60\pm 5)\%$. 2 $\Phi 10$ mm glass rods shall be put at the bottom of a flat container and then the test cubes with treated face adown shall be put on the glass rods. The 3.5wt% NaCl solution with temperature $(20\pm 2)^\circ\text{C}$ shall be added into the container until the liquid level is 1mm~2mm higher than the treated face. After 24h the test cubes shall be removed and put in the oven for dry 24h at 50°C . The powders which are collected by grinding concrete layer by layer with the unit of 1mm from the treated face shall then be put into the oven for dry 2h at $(105\pm 5)^\circ\text{C}$. The powders shall be removed out and put in desiccator for cooling at room temperature. 5 ~ 20 g powder sample shall be weighed and put into triangular flask and then the content of chloride ion shall be analysed. The other 9 powders of per mm depth shall be obtained according to the procedure above. The Cl^- penetration depth is expressed with the depth of the 0wt% concentration of Cl^- .

(3) The rapid chloride permeability test method.

The rapid chloride permeability test method is used widely and proposed in specifications such as AASHTO T259 [16], AASHTO T277 [17], ASTM C1202 [18] and JTJ275 [10]. The concrete specimens with $\Phi 100$ mm \times 50 mm shall be saturated with water under vacuum conditions and be fixed on the test chamber with the side face sealed. The copper mesh electrodes shall be placed at both ends of the specimen, while one end is immersed

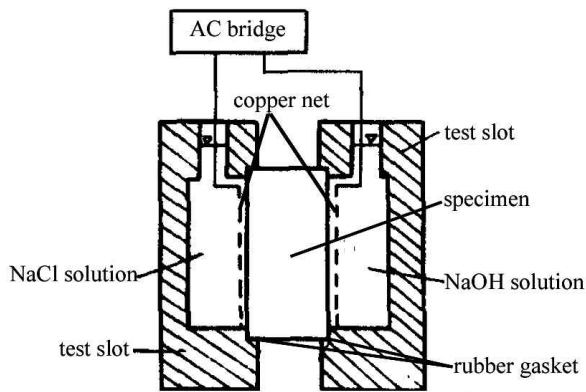

(a) The electricity test method

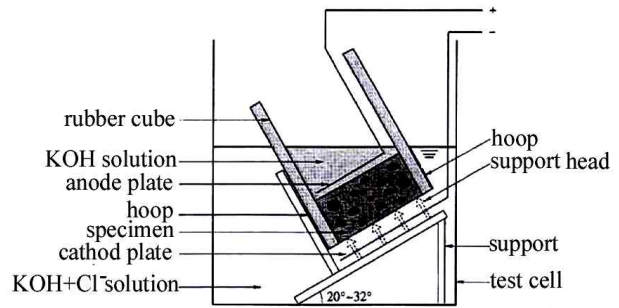

(b) The electro-migration test method

Fig. 3 Setup diagrams of two methods.

in 0.3 mol/L NaOH solution (anode) and the other end is immersed in 3wt% NaCl solution (cathode). During the test for 6 hours under 60 V DC voltage, the electric current is used to evaluate the permeability of concrete. The setup diagram is shown in Fig. 3a.

The specimen size and test parameters in this method are demanded especially. The test temperature is too high. Although the concentration of 3wt% NaCl solution is enough, the time 6h is too short to form a stable migration of chloride ion in concrete. The test results can not reflect the property of resistance to chloride ion permeability of concrete because it can be affected by the chemical composition in concrete pore.

(4) The electro-migration test method (RCM).

The electro-migration test method is shown in several specifications such as JTG/T B07-01 [11]. This method was first proposed by Luping Tang [19] and then be adopted by Nordic standards [20]. The thickness of concrete specimen is 50 mm. Two solution cells shall be fixed on two sides of the concrete, the anode solution cell contains 5wt% NaCl of 0.2 mol/L KOH solution and the cathode solution cell contains 0.2 mol/L KOH, The 30 V DC voltage shall be added between the anode and cathode solution. The test time will be determined by the start electric current. After the end of electro-migration test, the test specimen will be split and 0.1 mol/L AgNO₃ solution shall be sprayed on the flash split face. The white dividing line with the precipitate of AgCl shall be shown after about 15min. The impregnating depth of chloride ion is the width from white dividing line to the specimen original face. The chloride ion diffusion coefficient can be calculated by the penetrating depth of chloride ion. The advantage of this method is the short test time period. The disadvantage is that the calculate formula is complex

and the test error of Cl⁻ penetrating depth is lager. The setup diagram is shown in Fig. 3b.

(5) Discussion

4 methods above cannot be compared with each other. The method (1) and method (2) above are in-site test method by core-drilling and the method (3) and method (4) above are the lab test. But because the concrete specimen impregnated with SWR in the method (3) and method (4) must be water saturation by vacuumed and the hydrophobic layer is broken, the test method (3) and method (4) are not suitable for testing the concrete impregnated with SWR. In addition there is not the test method of resistant to salt fog of reinforced concrete impregnated with SWRs in these specifications.

5.2.2 The property of resistant to freezing-thawing of reinforced concrete impregnated with SWR

The test method in TB/T 3228 [15] is as follow: 8 concrete test cubes (W/C=0.70) shall be cast and cured for 28 days at (20±2) °C and relative humidity 95 %. Then they shall be conditioned for 60d at (21±2) °C and relative humidity (60±10) %. 4 test cubes shall be impregnated with SWR and then be cured for 14d at (21±2) °C and relative humidity (60±10) %. That the test cubes shall be put into 3wt% NaCl solution for 16h at -15 °C and then put into water for 8h at 20 °C is referred to as a cycle. The total cycle number must be more than 50 cycles and the weight loss of cubes must be tested per 5 ~ 10 cycles. The test time of that the test cubes shall be cured for 60d at (21±2) °C and relative humidity (60±10) % after 28d at standard cure condition in this method is too long. The specification JT/T991-2015 was released by the Ministry of Transportation of China about silane paste water repellent “Silane Paste Coating Material for Surface Protection of Bridge Concrete Structure”. By comparing

it with TB/T 3228, some modifies will be showed in this specification: 1) water cement ratio is modified to W/C=0.6 from 0.7, 2) the cure time is modified to 7d from 60d, 3) the number of test cubes is modified to 6 from 8, and 3 cubes shall be impregnated with SWR, 4) the criterion of judging property is modified as: the weight loss shall be tested per 5 cycles; the cycle number shall be recorded at once and the test can be stopped while the weight loss comes to more than 5wt% .

5.2.3 The property of resistant to UV aging of reinforced concrete impregnated with SWRs

The test method of resistant to UV aging in JG/T 337 [12] is as follow: 6 test cubes with 100 mm × 100 mm × 100 mm (W/C=0.6) shall be cast and then cured for 28d at standard environment. The other 4 faces except the treated face and its opposite face of the test cube shall be sealed with solvent-free epoxy resin coating. 3 test cubes shall be impregnated with SWR and be conditioned for 14d at (20±2) °C and RH(60±5) %. The test cubes which are dried at 50 °C for 48h in the oven shall be removed and be conditioned at (20±2) °C and RH(60±5) %. The treated cubes shall be put into the QUV aging instrument with QUV-A radiation, 1.5 W/m² radiation strength, at 50 °C and for 1000h test time. Then the water absorption rate of concrete after UV radiation according to the method of water absorption rate in JG/T 337 shall be tested.

There is a disadvantage in this method that the test cubes with 100 mm × 100 mm × 100 mm cannot be put into the QUV instrument because the requirement about sample size is that the thickness must be less than 10 mm and with width of 75 mm and length 125 mm. Wang Xuechuan *et al.* [21] studied the resistance to ultraviolet-light aging property of SWR which is impregnated on the cement mortar surface with mortar size 125 mm × 75 mm × 10 mm.

5.2.4 The property of resistant to alkali of concrete impregnated with SWRs

(1) The methods in JTG/T B07-01 [11] and JG/T 337 [12]

6 test cubes with size 100mm×100mm×100mm (W/C=0.45) shall be cast and then cured for 28d. The treated method is the same as that in clause 5.2.3 above. 3 test cubes shall be impregnated with SWR and then conditioned for 14d at (20±2) °C and RH(60±5) %. Then the test cubes shall be dipped in the 0.1mol/L KOH solution for 21d and then removed. Then they shall be condition for 7d at (20±2) °C and RH(60±5) % and weighed. The water absorption rate of test cubes after dipped in alkali is used to express the property of resistant to alkali.

But the difference of test method between JTG/T B07-01 and JG/T337 is that the test cubes shall be dried in air to constant weight (±2g) in JTG/T B07-01. Sun Hongyao *et al.* [22] discussed the test method of water absorption rate in specifications and found that it is difficult to reach the constant weight for concrete. So this method must be revised in the future.

(2) The test method in EN BD43/03 [6] and TB/T 3228 [15]

After the test of water absorption rate of reinforced concrete as section 5.3.1(2), the three treated test cubes shall be placed in individual beakers containing sufficient 0.1mol/L KOH solution to fully cover a test cube supported on a spacer with a head of (25±5) mm. The beakers are securely covered with cling film and left for (21±0.1) days. The test cubes shall be removed from the beakers and dried, suitably supported on a bench to allow air to circulate around each of the 6 faces, in the laboratory, until their weight is within ±2 g of their weight prior to the start of the immersion test (i_1). A second immersion test shall be carried out and the rate of increase in weight of each treated test cube after the alkali test $I_{t(alk)}$ is calculated. The absorption ratio (AR_{alk}) shall be calculated by the equation $AR_{alk}=(I_{t(alk)}/I_{um})\times 100\text{wt}\%$, where $I_{t(alk)}$ is the mean rate of weight gain of the three treated test cubes after immersion in alkali and I_{um} is the mean rate of weight gain of the three treated test cubes after immersion in alkali in grams

The requirement of resistant to alkali is less than 10wt% in the 2 methods above. But the research result of Sun Gaoxia [23] showed that the method (2) is easy to operate and has better repeatability.

5.3 The construction indexes of SWR

The construction indexes of SWR contain water absorption rate of concrete, the impregnating depth of SWR and drying rate coefficient.

5.3.1 The water absorption rate of concrete impregnated with SWRs

The test methods of water absorption rate of concrete impregnated with SWRs are not the same in standards listed in Table 2.

(1) Karsten flask method.

Karsten flask method which is given in specification of ZTV-SIB90 [24] and the papers of Basheer PAM [25] and Jiang Zhengwu [26] is a better test method of water absorption rate of concrete. Karsten flask is a graduated flask with different bottom size which has horizontal and vertical model (see Fig. 4 & Fig. 5).

The test procedure is as follow: the Karsten flask is fixed on the concrete surface and is sealed by seal material

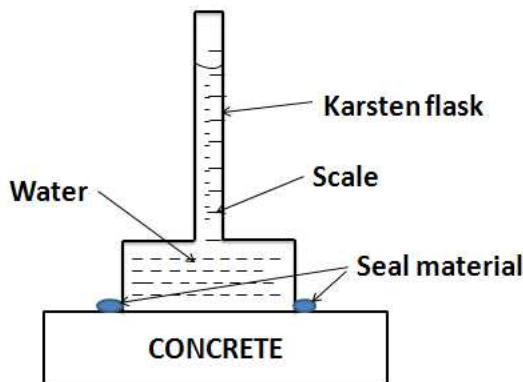

Fig. 4 Karsten flask on top face of concrete.



Fig. 5 Karsten flask on side face of concrete.

such as plasticine. Water is added into the flask to a certain scale, and then a drop of liquid paraffin is added to the surface of water to prevent evaporation of water. The start mark of water and start timing shall be record at once. The water absorption rate with time will be calculated according to the record of the mark of water at different time.

(2) The test method in EN BD43/03 [6] and TB/T 3228 [15]

Nine (100 mm × 100 mm × 100 mm) concrete test cubes shall be cast from a single batch of concrete (W/C=0.45) and cured for 28d at (20±2) °C and relative humidity 95 %. No oil or release agent will be permitted on the surface of the moulds. The test cubes shall be surface dried with an absorbent paper towel. Six test cubes, suitably supported to allow air to circulate around each of the 6 faces, shall be conditioned on a bench in the laboratory (at (21±2) °C and RH (60±10) %) for 7d until the moisture reached to (5.0±0.5) wt%. The remaining three test cubes shall be oven dried at (105±5) °C for 7d, cooled in a desiccator cabinet containing silica gel. Three test cubes from the batch shall be treated in a fume cupboard with the fan on immediately after conditioning. Each cube shall be treated by dipping each face with the SWR. One side of the cube, supported on the 2 mm plastic spacers, shall be dipped in the material for (120±5)s and then removed. The above procedure shall be repeated on the remaining six faces of each cube. The cubes shall be stored, suitably supported to allow air to circulate around all 6 faces, in the fume cupboard for (48±1) h after the start of treatment with the fan off. The treated cubes shall then be stored over a saturated potassium sulphate solution in an airtight box. The absorption test shall commence 14d after treatment. Sufficient demineralized water

(Conductivity < 50 µS) shall be placed into each of the 6 beakers so that each test cube supported on a spacer will be fully covered with a head of (25±5) mm (see Fig. 6). The three treated and the three untreated test cubes shall each be weighed (i_1) and immersed in demineralized water. The treated and untreated test cubes shall be removed from the water after (24.0±0.1)h and (1.00±0.02)h respectively, surface dried with an absorbent cloth and reweighed (i_2). The rate of increase in weight for each test cube (I_t) shall be calculated from the equation $I_t=(i_2-i_1)/t^{1/2}/S$, where t is 24.0 for treated cubes and 1.00 for untreated cubes and S is the surface area 0.06m². The absorption ratio (AR) shall be calculated: $AR=(I_m/I_{um})\times 100\%$, where I_m is the mean rate of weight gain of the three treated test cubes and I_{um} is the mean rate of weight gain of the untreated cubes.

(3) The test method in JTG/T B07-01-2006 [11]

The preparation of concrete test cubes is the same as the test method of the BD43/03 from the UK highway agency. Each test cube supported on a spacer shall be fully covered with a head of (25±5) mm of demineralized water for (21±0.1)d (see Fig. 6). Test cubes, suitably supported to allow air to circulate around each of the 6 faces, shall be weighed to the constant weight ±2g, and the water absorption rate (W_A) shall be calculated from the equation $W_A=(Wt_2-Wt_1)/(Wu_2-Wu_1)$, where Wt_2 and Wt_1 are the weight of treated cubes after immersion and before immersion respectively, Wu_2 and Wu_1 are the weight of untreated cubes after immersion and before immersion respectively.

(4) The test method in JTJ 275 [10]

The water absorption test shall commence at least 7d after treatment with SWR. The test cubes shall be obtained by drilling core with diameter 50 mm and depth (40±5)

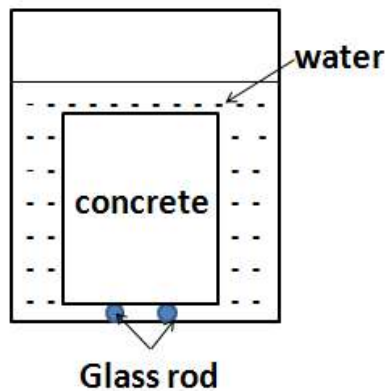

Fig. 6 Sketch map of test method in (2) and (3).

mm. The solvent-free epoxy resin coating shall be used to seal other faces except the test face and the region with less than 5 mm width from edge of original test face of the core sample. All test cores shall be weighed after drying for 48 hours at 40 °C. Several glass rods with Ø5mm shall be placed on the bottom of suitable container. The test cores with the test face down shall be put upon the glass rods and sufficient demineralized water at 23.0 °C shall be added into the container with the water level 1~2cm above the glass rods (see Fig. 7). The test cores shall be removed from the container and then weighed and then put into the container immediately after weighing at the time point 5, 10, 30, 60, 120 and 140 min. The variation of weight of water absorption at the time interval shall be converted to the variation of height (mm) of water absorption. The slope of the linear relationship ($\text{mm}/\text{min}^{1/2}$) shall be the water absorption rate, with the height (mm) as the vertical axis and with the square root of time interval ($\text{min}^{1/2}$) as the horizontal axis.

(5) Discussion

According to four methods above, only the Karsten flask method is a non-destructive test method of water absorption rate of concrete impregnated with SWR. The other test methods are done by core drilling or in the laboratory. The Karsten flask method is a suitable method for in-site test. According to the test results of the paper [22], the test method (4) is a suitable method for test the water absorption of concrete impregnated with SWR in laboratory.

5.3.2 The test method of impregnating depth of SWRs

Concrete is a porous material. The impregnating depth of SWR is relationship with the pore size, the amount of impregnants, environment and impregnating time. The

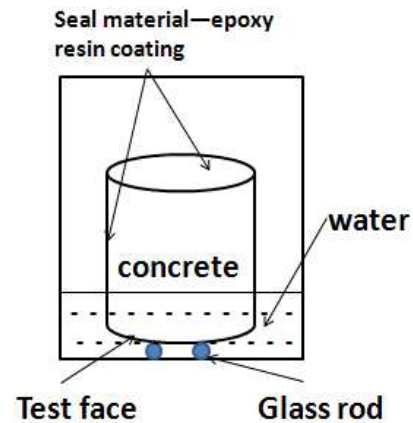

Fig. 7 Sketch map of test method in (4).

test methods of impregnating depth are given as follows.

(1) Dye indicator method

The method in JTJ 275 [10] is that: The test cores with diameter 50 mm and depth of 40 ± 5 mm shall be drilled out and sealed with sealed bags at least 7 d after impregnating of SWRs. The core specimens shall be split along the diameter direction after drying 24h at 40 °C. The water-based dye with short action time shall be sprayed on the split surface and the region without dye shall indicate the impregnating region of SWR. The impregnating depth can be gauged. The method is used increasingly popularly.

(2) Pyrolysis gas chromatography method

The method in JTJ 275 [10] is that: The test cores shall be drilled out and sealed with sealed bags at least 7d after impregnating of SWRs. The core specimens shall be split at the depth of 3-4 mm ($\leq C45$) or 2-3 mm ($> C45$) from the original face. Several powder samples shall be obtained from the flash face of the split cores and be pyrolysis for gas chromatography analysing. The average of weight percentage of impregnant to cement paste powder shall be calculated and the value of percentage should not be less than 0.1wt%. The method is so complicated that it is seldom used in practice.

(3) Spray water method

The method for determining the impregnating depth in JTG/T B07-01 [11] and in TB/T 3228 [15] is very simple. The test specimens shall be split and the water shall be sprayed on the flash region of split specimens, the region including impregnant will not be wet. The depth can be gauged from the not-wet region. Sun Gaoxia [23] described the test procedure in detail. The method is also used widely.

5.3.3 The test method of drying rate coefficient

Six test cubes shall be prepared and treated according to section 5.2.4(2). The 3 treated and 3 untreated test cubes shall be weighed (48 ± 1)h after the start of treatment (W_0) and then placed in the cabinet with a controlled environment of $(30\pm 2)^\circ\text{C}$ and $(40\pm 5)\%$ R.H. These test cubes shall be reweighed after (24.0 ± 0.1) h (W_1). The drying test shall then continue for further (24.0 ± 0.1) h. The test cubes shall then be reweighed (W_2) and the drying rate (D_i) of each test cube and the drying rate coefficient (DRC) shall be calculated: $D_i = (W_1 - W_2) / 24 / 0.06$ in $\text{g}/(\text{m}^2 \cdot \text{h})$ & $DRC = (D_i / D_{um}) \times 100\%$, where D_i is the mean drying rate of the three treated test cubes and D_{um} is the mean drying rate of the three untreated test cubes.

6. The Future Research Work about SWR

The SWR has been applied on the concrete surface for about 20 years. Many research works about SWR have been done by scientific workers and several specifications or standards have been released or published. But the results above show that a lot of works about SWR need future research such as follow.

(1) The test methods except Karsten flask method which is non-destructive method are core-drilling or done in laboratory, so the non-destructive method in-site need researched for controlling the quality efficiently.

(2) There are not the test methods about the property of resistant to salt fog and the property of resistant to carbonation of concrete in these specifications above. The concrete impregnated with SWR has the respiratory character and the water vapour may be penetrated into the concrete pore with Cl^- and CO_2 . If the environment temperature decreases quickly the liquid water may occur and may corrode the concrete. So the property of resistant to salt fog and property of resistant to carbonation need further study.

(3) The requirement of the drying rate coefficient is more than 30wt% in several specifications. But it is not suitable as an index of SWR, because it shall not be helpful for increasing the property of resistant to carbonation and resistant to freezing-thawing with the high gas permeability. The suitable value of drying rate coefficient need further research to determine.

(4) According to the sum of test methods above, that the test methods are not the same for the same index in different specifications is not helpful to control the quality. So the single suitable test method for the same index need further research to determine.

7. Conclusions

The SWR is impregnated on the concrete surface to prevent the infiltration of harmful medium and the treated concrete has the property of respiratory and keeping the original appearance of concrete. The SWR does not form film, so the hydrophobic layer has not the defects of bubble and loss of coatings. The SWR products were mainly from foreign companies in the early days of SWR application. After the efforts and research of domestic scientific workers, the domestic companies are able to produce qualified products of SWR in China. That several specifications have been released since the first specification about SWR was released in 2000 can play a guiding role in application of SWR. The properties of SWR contain the product property, the durability of concrete and the in-site construction quality control. These test methods about SWR in these specifications are summed. It is not helpful to control the quality that the test methods are not the same for the same index in different specifications. Finally the future research works are proposed about the future application of SWR such as the research of non-destructive method, the research of the property of resistant to salt fog and the property of resistant to carbonation and the suitable value of drying rate coefficient etc.

Acknowledgments

This work is financially supported by the National Natural Science Foundation of the P. R. China (51279110).

References

1. Z. H. Hu, *Port Waterw. Eng.*, **5**, 13 (1994).
2. G.-X. Sun, L.-x. Bie, H.-X. Liu, H.-Y. Sun, *Mod. Paint Finish.*, **6**, 3 (2010).
3. J. C. Dai and J. Z. Li, *Concrete*, **5**, 70 (2010).
4. J. C. Dai and J. Z. Li, *Journal of Highway and Transportation Research and Development: Applied Technology Edition*, **11**, 176 (2011).
5. M. J. Xie and S. Chen, *Urban Roads Bridges & Flood Control*, **1**, 116 (2011).
6. The Highways Agency of British, BD 43/03, The impregnation of reinforced and prestressed concrete highway structures using hydrophobic pore-lining impregnants (2003).
7. EN1504-2, Products and systems for the protection and repair of concrete structures (2004).
8. ACI 546R, Concrete repair guide (2001).
9. ICRI 03732, Selecting and specifying concrete surface preparation for selecting, coating and polymer overlays. (2005).
10. JTJ 275, Corrosion prevention technical specification for concrete structures of marine harbour engineering. (2000). (in Chinese)

11. JTG/T B07-01, Specification for deterioration prevention of highway concrete structures (2006). (in Chinese)
12. JG/T 337-2011, Agents of surface coating for protection of concrete structures (2011). (in Chinese)
13. CCES 01-2004, Guide to durability design and construction of reinforced structures (2004). (in Chinese)
14. TB10005, Code for durability design on concrete structure of railway (2010). (in Chinese)
15. TB/T 3228-2010, Durability repair and protection for railway concrete structure (2010). (in Chinese)
16. AASHTO T259, Standard method of test for resistance of concrete to chloride ion penetration (1992).
17. AASHTO T277, Standard method of test for rapid determination for the chloride permeability of concrete (1992).
18. ASTM C1202, Standard test method for electrical indication of concrete's ability to resist chloride ion penetration (1997).
19. T. Luping and N. L. Rapid, *ACI Materials Journal*, **1**, 49 (1992).
20. NT Build 492, Migration coefficient from non-steady-state migration cell experiments (1999).
21. X. Wang, H. Y. Sun, M. Shen, *et al.*, *Hydro-Science and Engineering*, **5**, 96 (2016).
22. H. Y. Sun, G. X. Sun, and C. Lu, *Highway*, **10**, 176 (2009).
23. G. X. Sun, *MD Thesis*, Nanjing Hydraulic Research Institute, Nanjing (2009).
24. ZTV-SIB90, Concrete surface protection Technical Specifications (1990).
25. P. A. M. Basheer, L. Basheer, D. J. Cleland, A. E. Long, *Const. Build. Mater.*, **11**, 413 (1997).
26. Z. Jiang, *China Harb. Eng.*, **6**, 27 (2006).