

A Study on the Simulator and Trouble Prediction Monitoring Methodology of the Automotive Air Conditioner

Il-Moon Son^{1*} and Hyo-Yean Kwak²

¹Dept. of Automotive Engineering, TongMyong University

²Dept. of Industrial Management, Suwon Science College

자동차 공조기의 시뮬레이터 및 고장예측 모니터링 기술에 관한 연구

손일문^{1*}, 곽효연²

¹동명대학교 자동차공학과, ²수원과학대학교 산업경영과

Abstract There has been an increasing interest in the market of vehicle maintenance and repair equipments to decrease air pollution. However, most of the existing air conditioning system equipment in Korea have poor performance as well as non-protection against air pollution. The purpose of this paper is to develop the monitoring technology of recovering and recharging refrigerant for air conditioning system, and also to develop its related diagnostic system. This technology and system can supply the exact amount of refrigerant from the charger to the air conditioning system by precisely diagnosing and monitoring their statuses. This technology can also control recovering and recharging of refrigerant exactly by altering the recovering pressures of refrigerant according to circumstance temperatures.

요약 자동차의 유지보수 및 수리를 위한 장비에서 환경오염에 대한 관심이 증대되고 있음에도 불구하고, 국내 자동차 공조시스템에 대한 대부분의 이러한 장비는 환경오염에 대해 무관심뿐만 아니라 그 기능도 뒤떨어진 것이 사실이다. 이 논문에서는 자동차 공조시스템의 냉매의 회수 및 재충전을 위한 모니터링 기술과 진단 시스템을 개발하였다. 이러한 개발된 기술과 시스템은 냉매상태의 정확한 진단과 모니터링을 통하여 자동차 공조시스템에 정확한 냉매량을 충전가능하게 해준다. 또한 이러한 기술은 주변 온도에 따라서 냉매의 회수압력을 조절함으로써 냉매의 회수와 충전에 대한 정확한 제어를 가능하게 해준다.

Key Words : Automotive Air Conditioning Simulator, Air Ventilation System, Diagnosis-Analysis System, Fully-Automatic Automotive Air Conditioner, Trouble Prediction Monitoring System

1. Introduction

For better fuel efficiency, R&D must be performed to improve the functionality of not only the engine, but also accessories such as air conditioning system driven by the power of the engine[1,2,3].

Also, recent air conditioning systems in vehicles are fully automatic systems. They not only serve as cooling and

heating systems, but also have air ventilation systems that keep the indoor air clean by shutting out harmful air coming in from the outside.

In other words, these systems automatically prevent harmful outside air from coming inside, and removes harmful air generated inside, thereby always keeping the air in the comfortable state, and automatically controlling the temperature, ventilation, purification and humidity of

*Corresponding Author : Il-Moon Son(TongMyong Univ.)

Tel: +82-51-629-1623 email: imson@tu.ac.kr

Received March 12, 2013

Revised (1st March 28, 2013, 2nd April 4, 2013)

Accepted April 11, 2013

the indoor air by means of electronic control[4].

In case a problem occurs in the automotive air conditioning system, the cooling and heating system may not function properly, and as a result, energy efficiency and the convenience of the driver may deteriorate[5,6].

Accordingly, this study is going to develop an automotive air conditioner diagnosis system equipped with the air conditioner refrigerant recovery/recycling/charging system necessary for not only checking the refrigerant inside the air conditioning system, but also the maintenance and inspection in case of trouble in the parts related to the air conditioner refrigerant.

In addition, this study intends to develop, as a means of analyzing the state of the refrigerant inside the air conditioning system, an automotive air conditioner monitoring system that can analyze the state of the refrigerant on a real-time basis and predict trouble when the air conditioning system of the vehicle develops electrical or mechanical trouble.

2. Experimental Apparatus and Methodology

2.1 System Configuration

Fig. 1 illustrates the schematic diagram of the system used in this study. The system developed in this study largely consists of the air conditioner refrigerant recovery/recycling/charging system, automotive air conditioning simulator, monitoring system, diagnosis system, analysis system, and control system.

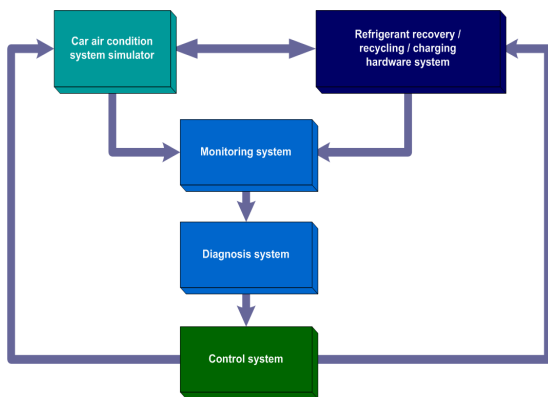

[Fig. 1] System schematic diagram

2.2 Air Conditioner Refrigerant Recovery Recycling Charging System

Fig. 2 illustrates the configuration of the air conditioner refrigerant recovery recycling charging. The air conditioner refrigerant recovery charging system consists of compressor, condenser, vacuum pump, accumulator, oil separator, refrigerant tank, solenoid valve, pressure switch, pressure and temperature sensor, and oil exchanger.

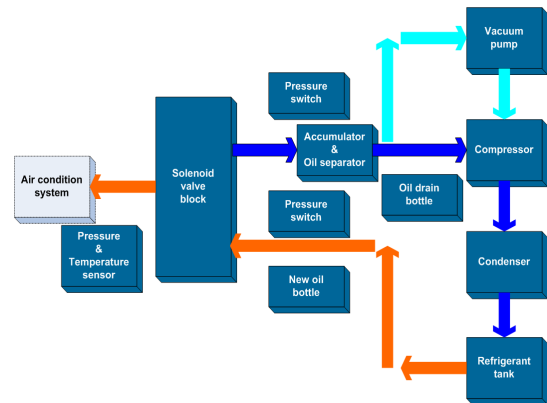

[Fig. 2] Composition of Refrigerant Recovery/ Recycling/ Charging System

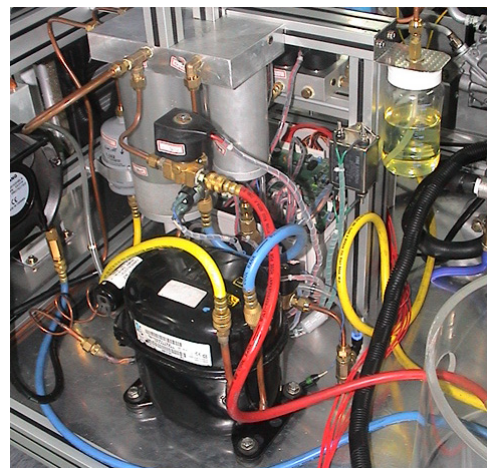

[Fig. 3] Refrigerant Recovery/Recycling/Charging System

Fig. 3 shows the photograph of the actual air conditioner refrigerant recovery recycling charging system. For real-time measurement of the pressure and temperature at the high-pressure and low-pressure lines of the automotive air conditioning system, the pressure sensor and the temperature sensor were installed.

The amount of the refrigerant in the refrigerant tank can be measured by means of the load cell, and 9 solenoid valves and 3 pressure switches were installed on each line.

Meanwhile, the air conditioner refrigerant recovery/recycling/charging system was installed inside the air conditioning simulator, and for the initial test, an additional analog pressure gauge was installed on the high-pressure and the low-pressure lines respectively.

[Table 1] Solenoid Valve Movements

Classification	Recovery and Recycling	Waste Oil	Vacuum	New Oil	Charging	Diagnosis
High pressure solenoid valve	On	Off	On	Off	Off	On
Low pressure solenoid valve	On	Off	On	Off	Off	On
Recovery solenoid valve	On	Off	Off	Off	Off	Off
Vacuum solenoid valve	Off	Off	Off	Off	Off	Off
Oil drain solenoid valve	Off	On → Off (3x)	Off	Off	Off	Off
New oil solenoid valve	Off	Off	Off	On	Off	Off
Charge solenoid valve	Off	Off	Off	Off	On	Off
Recycle solenoid valve	Off	Off	Off	Off	On	Off
Air purge solenoid valve	On → Off (3x)	Off	Off	Off	Off	Off
Compressor	On	Off	On	Off	Off	Off
Condenser fan	On	On	On	On	On	Off
Vacuum pump	Off	Off	On	Off	Off	Off
Pressure	8 bar → -20 inHg	-20 inHg	-30 inHg	-30 inHg	5 bar	

Table 1 shows the movement of the solenoid valves according to the operating modes of the air conditioner refrigerant recovery/recycling/charging system. Each solenoid valve uses the pressure sensor installed at the connection between the high-pressure line and the low-pressure line to control feedback as to whether each processor is normally working during recovery, vacuum and charging, and if the normal pressure is reached, the valve moves to the next process.

When the recovery, recycling and charging process is completed, the automotive air conditioning system is activated to detect the refrigerant pressure on the high-pressure and low-pressure lines, and decide whether or not the automotive air conditioner is working properly and

whether or not additional refrigerant needs to be charged and recovered, and if necessary, it performs the corresponding process.

2.3 Pressure and Temperature Sensor

Fig. 4 illustrates the pressure sensor and the temperature sensor installed on the high-pressure and low-pressure lines of the automotive air conditioning system. The pressure sensor is exclusively for refrigerant. The low pressure sensor can measure -1~10kg/cm², and the high-pressure sensor can measure -1~35kg/cm² so that the entire range of changes in the pressure of the refrigerant in case of trouble can be measured. The temperature sensor uses a CA-type thermocouple.

Fig. 5 illustrates the result of validating the measurements of the pressure sensor for monitoring and analyzing the pressure of the high-pressure line and the low-pressure line. The range of the output voltage is F.S. 5V, and shows linearity.



[Fig. 4] Pressure and Temperature Sensors

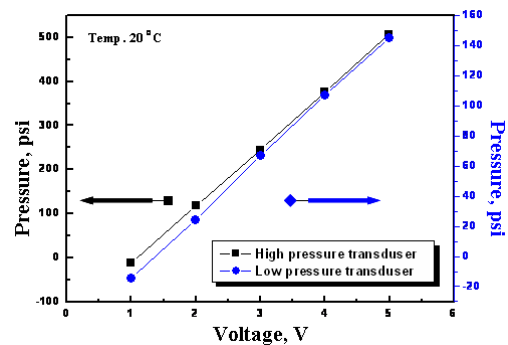

[Fig. 5] Verification Analysis of Sensors

2.4 Automotive Air Conditioning Simulator

2.4.1 Air Conditioning Simulator Motor and Heater Temperature Controller (A in Fig. 6, Fig. 7)

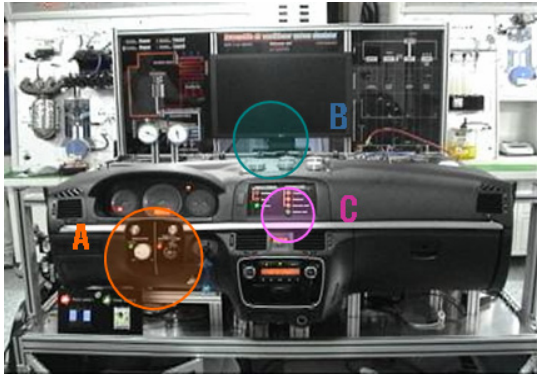

[Fig. 6] Automotive Air Conditioning Simulator



[Fig. 7] Speed Regulator and Heater Temperature Regulator

1) Speed Controller

A motor rpm controller is installed so that a 3-phase induction motor can be used to implement a compressor driven by the shaft power of ordinary engine load in a way fit to the engine load and rpm. This makes it possible to check the operating characteristics of the air conditioning system, including the idling state (800rpm) and the acceleration state (~1800rpm), on the basis of rpm control.

2) Heater Temperature Controller

A device, which enables the air conditioning system to

control the temperature of the cooling water of the heater system without actually running the engine, is installed. Temperatures can vary between 0 and 120 °C, and such values correspond to the temperature value of the water temperature sensor.

2.4.2 Air Conditioner Sensor Output Signal Controller (B in Fig. 6, Fig. 8)

A device, capable of arbitrarily controlling the changes in the outputs of the sensor installed in the system, is installed to enable mode conversion and automatic control of the air conditioning functions in various modes according to the sensor output value of the fully-automatic system.



[Fig. 8] Air Conditioner Sensor Output Signal Controller

2.4.3 Mechanical Trouble Controller of Air Conditioning Simulator (C in Fig. 6, Fig. 9)

1) Refrigerant Amount Controller

A control switch can be installed to vary the refrigerant amount so that it is possible to check the excess or shortage of the refrigerant due to overcharging and non-charging.

2) Air Conditioner Component Trouble Controller

In Fig. 9, the switch of the trouble system is operated to open and close the solenoid valve on the line through which the air conditioner refrigerant flows so that trouble of main components, i.e. compressor, condenser, and expansion valve, can be arbitrarily created.

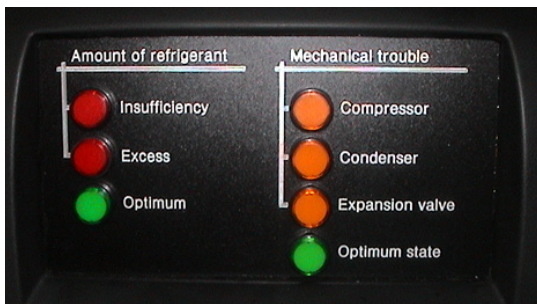

[Fig. 9] Component and Regulator of Mechanical Trouble

3) Trouble System

To arbitrarily create mechanical trouble of the normally working air conditioning system, solenoid valves, as shown in Fig. 10, in necessary places create trouble in the compressor, condenser and expansion value on the line, and then the individual valves are turned ON/OFF.

Lines and joints, which are the same as those on a real vehicle, were selected during the design stage, and the pressure sensor and the temperature sensor were installed to prevent refrigerant from leaking at the joints and to monitor the state of refrigerant, thereby making it possible to gather data on a real-time basis.

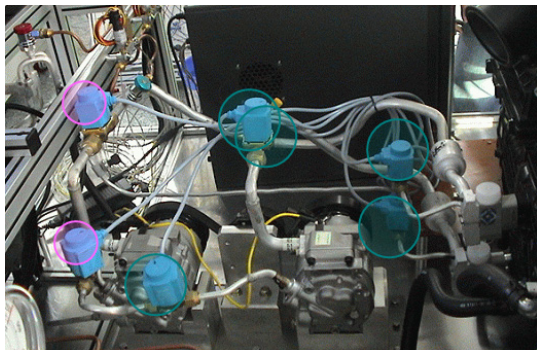

[Fig. 10] Mechanical Trouble System

Fig. 11 illustrates the schematic diagram of the air conditioner trouble system. Piping loss was minimized to keep it from interfering with the flow of refrigerant, and solenoid valves for new refrigerant were used to prevent trouble or any problem rising from the amount of refrigerant so that they can withstand high internal pressure (30kg/cm²). Also, setup tests and solenoid tests were conducted to check if there is any cooling loss and solenoid malfunction due to interference at the junctions. Durability tests and operation

tests were also performed to check for any problem in the trouble cycle.

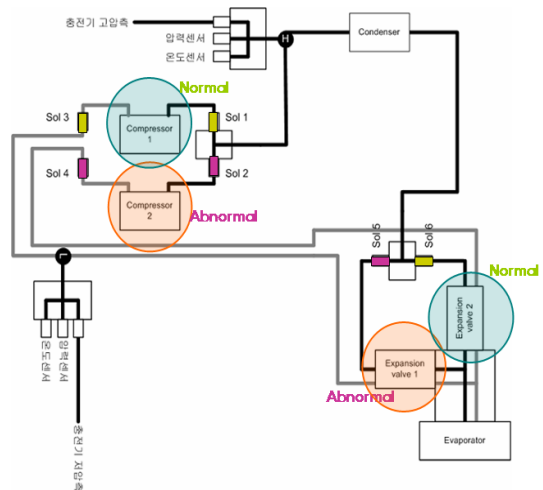

[Fig. 11] Scheme Diagram of Mechanical Trouble System

[Table 2] Solenoid Valve Movements (sol.: ON)

Trouble No.	Sol 1	Sol 2	Sol 3	Sol 4	Sol 5	Sol 6
Normal						
Compressor						
Condenser	Intermittence					
Expansion al.						

3. Diagnosis System and Data Analysis

This system analyzes the pressure and temperature data of each measured part for self-diagnosis so that performance of the air conditioner affected by the electrical trouble and mechanical trouble in case of system trouble, and the performance of the air conditioner refrigerant recovery/recycling/charging system can be analyzed.

The trouble system is configured in such a way that the charging system can diagnose general states of the mechanical trouble including implementation of normal state, lack of condensation due to excess of refrigerant, shortage of cooling water due to gas leak, lack of compression of the refrigerant due to the trouble of the compressor, problems caused by the trouble of the expansion valve, and poor circulation of refrigerant due to the trouble of the condenser.

3.1 Analysis Program

The analysis program shown in Fig. 12 samples the output and control voltage values of the sensor and actuator for the same input items as the monitoring items, and graphically represents the changes in the refrigerant and related conditions according to the operating status of the automotive air conditioning system for self-diagnosis and acquisition of data.

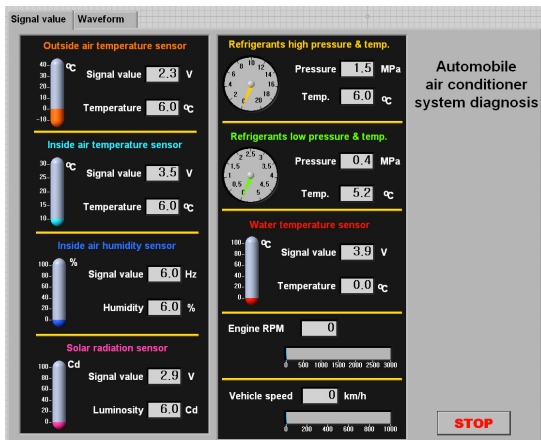

[Fig. 12] Output Data Values of Sensor & Actuator

Fig. 13 illustrates the analysis of the temperature and pressure measurements under different conditions. The air conditioning simulator was used to create the normal state of the air conditioning system, shortage or excess of the refrigerant amount, compressor trouble, expansion valve trouble, and condenser trouble.

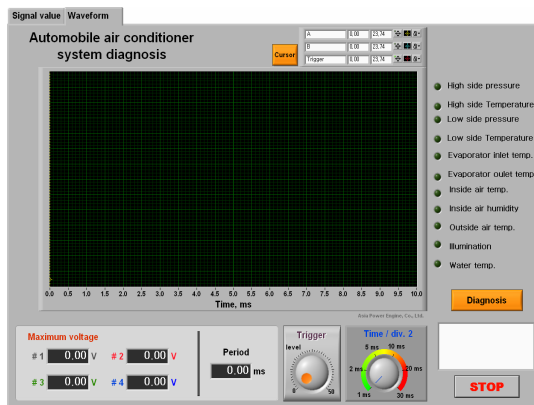

[Fig. 13] Refrigerant and Connection Condition Change Graph Construction and Diagnosis Program

The air conditioner recovery/recycling/refrigerant charging system uses the output values of the temperature and pressure sensor installed on the high-pressure and low-pressure lines of the automotive air conditioning system to measure temperature and pressure in each condition, and measure the temperature at the inlet and outlet of the evaporator coming from the air conditioning simulator at the same time.

3.2 Examination of the Result of Trouble

Fig. 14, Fig. 15 and Fig. 16 show the resulting pressure and temperature values measured in each conditions to validate trouble prediction.

The results suggest that, as temperature and pressure do not vary much from condition to condition, they can be utilized as air conditioner diagnosis data. Besides, in the normal state, the variation in temperature and pressure appears in a different area than in other conditions.

The pressure was lower near the high-pressure line than in the normal state when the refrigerant amount varied, and near the low-pressure line, the excessive amount of refrigerant led to high pressure distribution. In case of mechanical trouble, the impact of the compressor and the condenser seemed to be greater than that of the expansion valve. The temperature in case of trouble was lower than in the normal state.

Accordingly, the analysis program can predict the state of the air conditioner refrigerant in the normal state, or mechanical trouble.

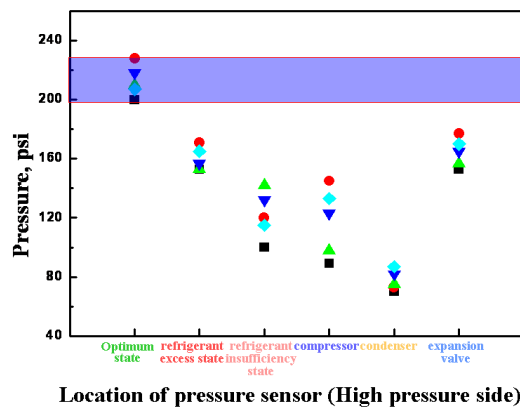

[Fig. 14] Pressure Data in High Pressure Line

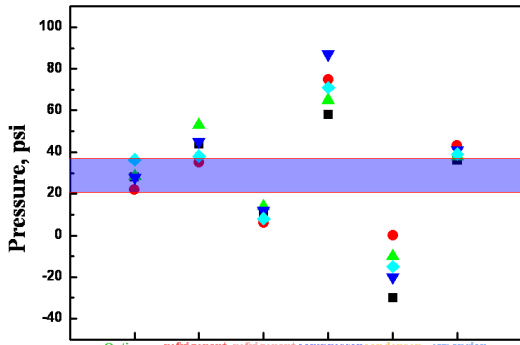

Location of pressure sensor (Low pressure side)

[Fig. 15] Pressure data in Low Pressure Line

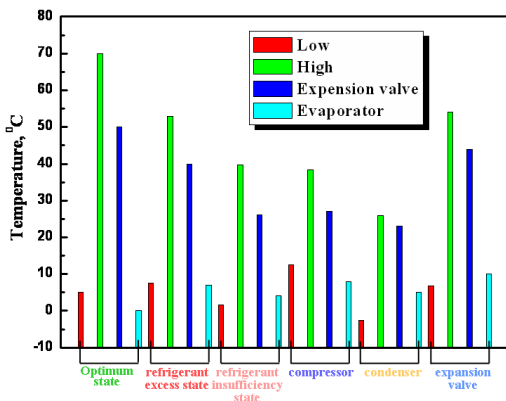

[Fig. 16] Result Data by Temperature Change

4. Conclusion

The developed automotive air conditioner simulator can be useful in education and research for parts of the air conditioner system.

And, this study developed a diagnosis and monitoring system capable of checking the refrigerant of the automotive air conditioning system on a real-time basis, and the analysis program for more efficient operation with validated effectiveness.

But, as future research, it is recommended to study more strictly on the failure mode and effect analysis and the reliability of trouble prediction monitoring.

Postscript

The authors owe great thanks to the parties concerned of the Research Institute attached to Asia Power Engine Co., Ltd. for their help with the development and research of the system used in this paper.

References

- [1] S. Y. Yang and Y. K. Song, "Design Technology of Automobile Air Conditioning System", Transaction of KSAE Vol.18, No.6, pp.46~61, 1996.
- [2] M. Y. Lee, C. W. Cho, H. S. Lee, and J. P. Won, "Performance Characteristics of the Electrical Air Conditioning System for the Zero Emission Passenger Vehicle", Journal of the KAIS, 12 (12), 2011.
- [3] M. Y. Lee, J. P. Won, D. Y. Lee, and C. W. Cho, "Study on the Performance Characteristics of the Roof Mounted Electrical Air Conditioning System Using Inverter Scroll Compressor", Journal of the KAIS, 12 (10), 2011.
- [4] C. W. Kim, Theory and Practice of Automotive Air Conditioners, Published by Mijun Science, 2006.
- [5] Goen Ho Lee, Jong Dae Jeong, Gyu Hwan Choi, Jeong Yeol Yoo, "Experimental Study of the Performance of Automotive Air Conditioners According to the Change in Refrigerant Amount," SAE. No.98370041, pp203~211, 1998.
- [6] D. S. Jung, Development Trend of New Alternative Refrigerant, KRAIA, Vol.25, No.6, pp.479-488,1996.

Il-Moon Son

[Regular member]



- Feb. 1986 : Dong-A Univ., Dept. of Industrial Engineering, MS
- Feb. 1994 : Dong-A Univ., Dept. of Industrial Engineering, PhD
- Mar. 2006 ~ current : TongMyong University, Dept. of Automotive Engineering, Associate Professor

<Research Interests>

Automotive Ergonomics, Safety Engineering of Transport, Automation and Control, Engineering Education

Hyo-Yean Kwak

[Regular member]



- Feb. 1992 : Dong-A Univ., Dept. of Industrial Engineering, MS
- June 1999 : Dong-A Univ., Dept. of Industrial Engineering, PhD
- Mar. 2002 ~ current : Suwon Science College, Dept. of Industrial Management, Assistant Professor

<Research Interests>

Factory Automation, Industrial Ergonomics, Safety & Health Management, Job Stress, Engineering Education