

논문 2010-2-22

# 가변성 고속 비트율을 위한 새로운 AOCG-OFDM 변조 기술

## A Novel AOCG-OFDM Modulation Technique for Variable-high-bit-rate

공형윤\*

Hyung Yun Kong\*

요 약 다중 부호 변조는 무선 환경에서 고속의 데이터 전송을 위해 개발되었지만 직교 부호(OC)의 제한된 자원과 높은 평균 전력 대 최대 전력 비(PAPR)와 같은 치명적인 두 가지 문제점을 가지고 있다. 본 논문에서는 위와 같은 문제점을 해결하고 사용자의 요구된 서비스 질(QoS)에 따라 네 가지 변수들로 조절 할 수 있는 가변성 고속 비트율을 얻기 위하여 AOCG(Advanced Orthogonal Code Group)-OFDM(Orthogonal Frequency Division Multiplexing) 이라 부르는 새로운 변조 기술을 제안한다

**Abstract** The Multi-code (Mc) modulation has been developed for high-speed data transmission over the wireless environments, but it suffers two critical problems due to the limited resource of Orthogonal Codes (OC) and high Peak-Average Power Ratio (PAPR). In this paper, we propose a novel modulation technique called AOCG [1] (Advanced Orthogonal Code Group)-OFDM (Orthogonal Frequency Division Multiplexing) to solve the above problems and obtain the variable high bit rates which can be controlled by the four parameters depending on the quality of services (QoS) required by users.

**Key Words :** OFDM, AOCG, Multi-code.

### I. Introduction

Recently, communication systems are expected to meet a drastically increasing demand of information, communication and entertainment services such as voice, data, image, video and etc, and users want be accessed anywhere at anytime. There are multiple solutions to achieve this aim and one of them is the devise of the advanced modulation and demodulation techniques. In W-CDMA, Mc-modulation has been proposed for supporting high data rates as well as

multi-media wireless communications, but it has two critical problems. First, it uses typically so many orthogonal sequences<sup>[2]-[3]</sup> that the hardware complexity to implement increases dramatically. Second, the linear combination of orthogonal codes also creates high PAPR. In <sup>[1]</sup>, we investigated and proposed the technique called AOCG to reduce the number of orthogonal sequences for the high-speed data transmission without increasing the number of OCs. To continue our work in lessening the second disadvantage of Mc-modulation, we apply OFDM. Therefore, instead taking linear summation of signals after spread by the orthogonal codes, each one is transmitted by the

\*정회원, 울산대학교/전기전자정보시스템공학부  
접수일자 2010.03.14, 수정일자 2010.4.12

different overlapping-orthogonal subcarriers. It is easy to recognize PAPR reduction. Consider an example of the simplest case in which two equal-value quantities are added together before modulated by a single carrier (the case of conventional Mc-technique). Obviously the resulting signal will have the amplitude of square root of 2 times that of the composite signal generated by modulating them with two in-phase and quadrature-phase carriers. Expanding such reasoning to the cases of many orthogonal subcarriers makes OFDM possible to achieve a lower PAPR. Moreover, OFDM application can take its advantages such as high spectral efficiency, robustness against frequency selective multi-path fading, and especially, the complete ISI (inter-symbol interference) suppression by inserting a guard interval with length greater than the maximum delay spread of channel. Furthermore, the proposed ACOG-OFDM modulation technique will be proved to have a very high flexibility in adjusting the data rate with respect to four parameters depending on the requested QoS. The rest of the paper is organized as follows. All details on the suggested AOCG-OFDM modulation technique is introduced in section 2. For the simulation, we describe the channel environment in part 3 and the simulation results are shown in section 4. Also, there is a thorough discussion of the proposed technique in this part, too. Finally, it is ended with conclusion with further research topics in part 5.

## II. Modulation Technique

The block diagram of the proposed modulation is shown in Fig. 1. First, the polar NRZ input data stream (see Fig. 2) is split into MD parallel sequences, where M is the number of advanced orthogonal codes of

d=1				d=2				...	d=D			
a <sub>1,1</sub>	a <sub>2,1</sub>	...	a <sub>M,1</sub>	a <sub>1,2</sub>	a <sub>2,2</sub>	...	a <sub>M,2</sub>	...	a <sub>1,D</sub>	a <sub>2,D</sub>	...	a <sub>M,D</sub>

그림 2. D 데이터 그룹의 구조체  
Fig. 2. Structure of D data groups

length-L and D is the subcarrier number. Then each subblock of M consecutive symbols is spread by the same ACOG and summed together before spread once again by the orthogonal code that is used to distinguish this subblock from the other subblocks.



그림 1. 변조 기법의 블록도  
Fig. 1. Modulation block

Finally, the resulting spectrum-spread signals are modulated by different overlapping orthogonal subcarriers and added up to generate a composite signal for the  $k^{th}$  data block as follows

$$s(t) = \sum_{d=1}^D \sum_{i=1}^M a_{i,d}(k) [AOCG_i p(t - nT_{AOCG} - kT)] * [OC_d p(t - jT_c - kT)] \cos(2\pi d\Delta ft),$$

for  $k = 1 \sim \infty, j = 1 \sim N, n = 1 \sim L$

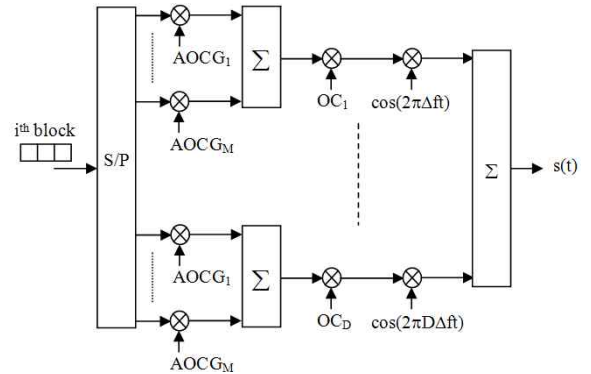
(1)

where

- $a_{i,d}$  : the  $i^{th}$  data symbol of the  $d^{th}$  subblock
- $AOCG_i$  : the  $i^{th}$  advanced orthogonal code of length L
- $OC_d$  : the  $d^{th}$  orthogonal code of length N
- $T_c$  : the chip duration of OCs
- $T = MDT_b$  : the time duration of a data block
- M : the number of advanced orthogonal codes of length-L

- D : the subcarrier number
- $T_b$  : the original data period
- $p(t-T)$  : the unit-amplitude rectangular pulse with duration T

$$p(t-T) = \begin{cases} 1, & 0 < t < T \\ 0, & elsewhere \end{cases} \quad (2)$$

- $\Delta f$  : the frequency spacing between two adjacent subcarriers.

To guarantee the orthogonality of subcarriers,  $\Delta f$  must be proportional to an integer number of chip rate  $R_c$ . In this paper, it is adopted as  $\Delta f = 1/T_c$ .

Fig. 3 demonstrates some time durations of the orthogonal code  $OC_i$ , the advanced orthogonal code  $AOCG_i$  and symbol on each branch.

It is easy to infer that

$$T_c = \frac{MDT_b}{N} \quad \text{or} \quad r_b = \frac{MD}{NT_c} \quad (3)$$

where

- $r_b = 1/T_b$  : the data rate

Also the number of symbols of each subblock must be less than the length of the advanced orthogonal codes AOCs (see Fig.1); that is,

$$M \leq L \quad (4)$$

From Eqs. (3) and (4), it can be found that in order to vary the bit rate of the system while remaining the chip rate of the main orthogonal code unchanged as for the conventional Mc-technique(CMT) used for multi-rate services [4], the new modulation technique offers a more flexible selection of the decisive

parameters. In the case of the Mc-technique, the bit rate can be only adjusted by two parameters D and N. Because of the shortage of the number of OCs, Mc-technique is limited for use in the high-speed applications. On the contrary, the proposed method is superior to the Mc-technique by adding two new variables M and L without increasing the number of OCs (explained below). Therefore, it is suitable for the variable bit-rate systems that are required for the future demands of various services. Fig. 4 shows the relation between  $r_b$ , M, D in the three-dimension space for the fixed values  $N=64$  and  $L=16$ . Naturally, data rate can reach the maximum value of 8 times the chip rate.

The processing gain of  $OC_i$  with respect to  $AOCG_i$  is given by

$$G = \frac{T_{AOCG}}{T_c} = \frac{N}{L} \quad (5)$$

For any system using spread spectrum technique, the processing gain G has a significant effect on the BER performance of the system.



그림 4. M, D,  $r_b$ 의 그래프

Fig. 4. Relation of M, D,  $r_b$

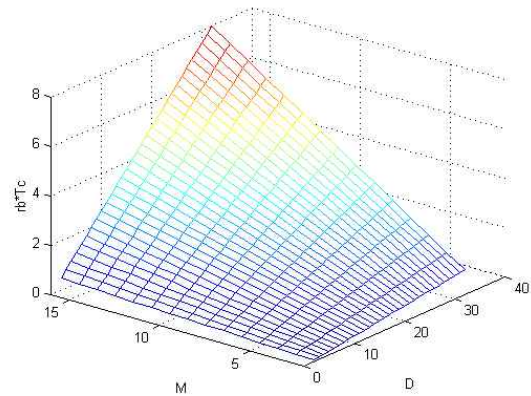

그림 3. L=4, N=16 일 때 시간 주기

Fig. 3. Time periods of some signals (L=4, N=16)

The larger G, the lower BER the system attains. This system has also such a similar property. Also, the above processing gain is independent on the number of the OCs.

The bandwidth of the signal s(t) is given by

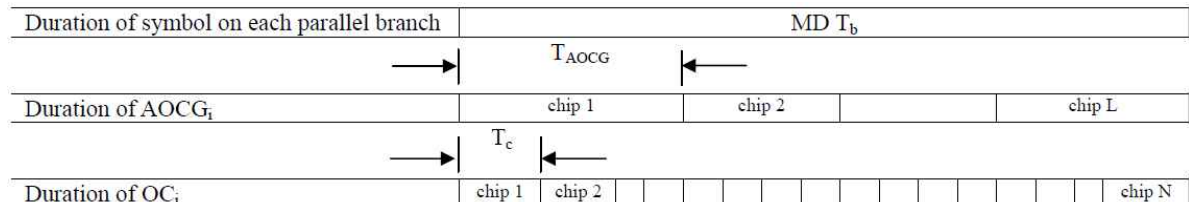
$$BW = D\Delta f = \frac{D}{T_c} \quad (6)$$

By combining with (3) and (5), we have

$$BW = \frac{N}{M} r_b \quad (7)$$

Consider a Hadamard matrix of size 8x8 as in Fig.5. The maximum number of the OCs is 8 and they are chosen from each row of the matrix  $H_{8 \times 8}$ . At that time, [1] proved that there exists AOCGs that can be used in combination with all OCs to distinguish among the branches in Fig. 1. Therefore, AOCGs were designed to reduce the number of OCs, which is the critical drawback of the Mc-technique in obtaining a high information data rate. These AOCGs are adopted from the lower-right square matrices of the elemental Hadamard matrices. For a certain NxN Hadamard matrix, multiple AOCGs with different size can be created with respect to a tree structure as in Fig. 6.



그림 5. OCs와 AOCGs의 하다마드 행렬  
Fig. 5. Hadamard matrix for OCs and AOCGs

For the specific example of Fig. 5, the AOCGs are surrounded by the boxes.

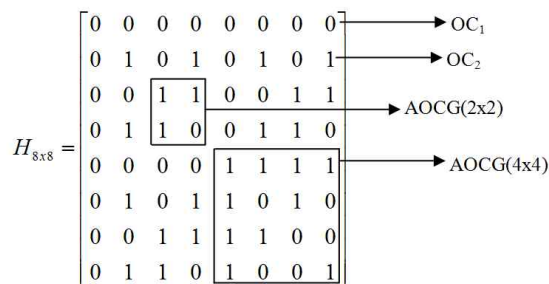

그림 6. AOCGs와 하다마드 행렬(검은색으로 칠해진 부분은 NxN의 하다마드 행렬을 만들기 위한 AOCGs)  
Fig. 6. Construction of Hadamard matrix and AOCGs (the filled areas are the AOCGs for any Hadamard matrix with size NxN)

Another problem of the Mc-technique is to cause a high PAPR that deteriorates the performance of the RF amplifiers. To solve it, the new modulation technique suggests utilizing the overlapping orthogonal multi-carriers to transmit each signal spread by the distinct OCs.

The demodulation process is performed in the inverse way of the modulation part as shown in Fig.7.

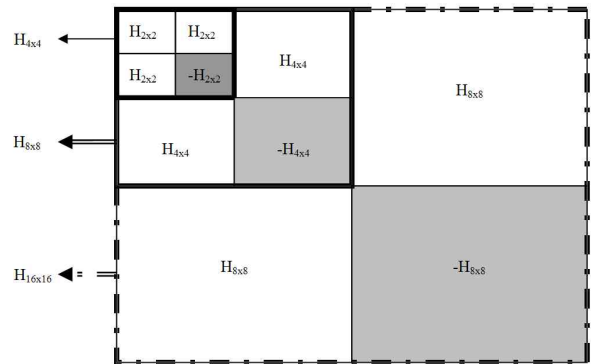

그림 7. 복조 기법의 블록도  
Fig. 7. Demodulation Block

First, the received base-band signal is multi-carrier-demodulated to form the separate signals for each subcarrier. Assuming that the carrier synchronization is perfect, the resultant signal on each parallel branch is of the following form

$$r_d = \sum_{i=1}^M a_{i,d}(k) [AOCG_i p(t - nT_{AOCG} - kT)] \quad (8)$$

$$* [OC_d p(t - jT_c - kT)] a_{d,j},$$

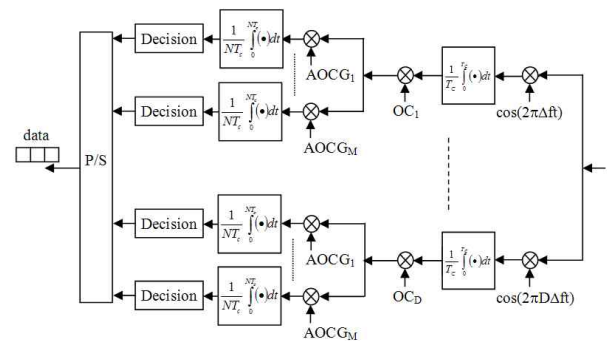
for  $k = 1 \sim \infty, j = 1 \sim N, n = 1 \sim L$

where  $\alpha_{d,j}$  is the channel gain on the  $j^{th}$  chip of the  $d^{th}$  orthogonal code. Subsequently, they are despread twice by its own orthogonal codes  $OC_d$  and advanced orthogonal codes  $AOCG_i$  to recover the original data symbols  $a_{i,d}(k)$ . The detected symbols are given by

$$a'_{i,d} = \text{sgn} \left( \frac{1}{NT} \int_0^{NT} r_d [OC_d p(t - jT_c - kT)] \right)$$

$$* [AOCG_i p(t - nDT_b - kT)] dt$$

for  $k = 1 \sim \infty, j = 1 \sim N, n = 1 \sim L$

(9)

Here,  $\text{sgn}(\cdot)$  is the signum function. Finally, the restored symbols  $a'_{i,d}$  are parallel-to-serial converted to regenerate the order of the transmitted data stream.

### III. Channel Model under BER investigation

The complex equivalent low-pass time-variant impulse response of p-path frequency selective Rayleigh fading channel is given by <sup>[5]</sup>

$$h(t, \tau) = \sum_{i=1}^p g_i(t) \delta(t - \tau_i) \quad (10)$$

where  $g_i(t), \tau_i$  are gain and delay of the  $i^{th}$  path in the power delay profile of channel. This paper assumes the channel to be WSSUS (Wide Sense Stationary Uncorrelated Scattering), and thus,  $g_i(t)$  is a mutually independent complex Gaussian random process with zero mean, variance  $\sigma_{gi}^2$  (Jakes-like

algorithm for  $g_i(t)$  coefficients generation found in <sup>[5]</sup> and the autocorrelation function <sup>[5]</sup>:

$$R_{g_i}(\Delta t) = \sigma_{gi}^2 J_0(2\pi f_{dmax} \Delta t) \quad (11)$$

in which  $J_0(\cdot)$  and  $f_{dmax}$  are the zero-order Bessel function of the first kind and maximum Doppler frequency, respectively.

If the condition  $\Delta f \ll B_C \ll BW$  ( $B_C$  : coherent bandwidth of channel,  $BW$ : total bandwidth of system) is satisfied, then each subcarrier only undergoes a flat fading. Therefore, the Fourier transform of  $h(t, \tau)$  is the channel's frequency domain transfer function  $H_n$  of the following form:

$$H_n = \alpha_n e^{j\phi_n} \quad (12)$$

where  $\alpha_n$  is the amplitude and  $\phi_n$  the phase in the  $n^{th}$  subchannel or the  $n^{th}$  subcarrier due to fade;  $\alpha_n, \phi_n$  are constant during each symbol interval but fluctuate over longer periods of time.

### IV. Simulation Results and Discussions

The different propagation environments such as purely AWGN and AWGN plus frequency selective Rayleigh fading are under investigation. For the case of fading channel, we assume that the fade is flat and unchanged during each chip time of the orthogonal codes OCs but swings from a chip to another. Moreover, the length of OCs is restricted to  $N=64$  by using Walsh-Hadamard codes. BER performance is evaluated over the variation in the length of AOCs  $L$ , the number of AOCs  $M$  and of OCs  $D$ .

(1) Case 1:  $M=L$

Fig. 8 shows the performance of the proposed modulation technique for different values of  $D$  and  $M$  under AWGN channel. It is realized that BER is independent on  $D$  for any certain value of  $M$ . It is true because the AOCs are chosen without the same shape in the time domain as the OCs [1]; that is, the orthogonality of OCs are remained to completely separate each subblock from the others. From Eq.(3) and Fig. 8, we also infer that for the previously required QoS that is equivalent to the preset value  $M$ , the bit rate can be significantly increased by adding the OCs without increasing the transmission bandwidth as well as BER. The same remarks can also be obtained for the case of the fading channel. However, due to fading, the OCs are not orthogonal to each other and thus leading to the degradation in the performance compared to the AWGN channel.

The reason causing the performance deterioration of the new technique when  $L$  increases is the decrease of the processing gain (see Eq.(5)). As a result, there is still a tradeoff between data speed and modulation performance. However, compared to the  $M_c$ -technique, the new one is more dynamic owing to having two more parameters  $L$  and  $M$  to control the bit rate.



그림 8. AWGN 채널 상에서의 BER 성능 그래프  
Fig. 8. BER performance under AWGN channel

(2) Case 2:  $L < M$

The following simulation results consider the

constant values of  $L=8$ ,  $D=4$  and  $N=64$  while  $M$  is varied. Fig. 9 illustrates that the larger the number of AOCs, the worse the performance. Moreover, the characteristic of the channel also has the adverse effect on the performance, especially, fading destroys the orthogonality of OCs and AOCs and therefore leading to the considerable decrease in performance in comparison to AWGN channel.

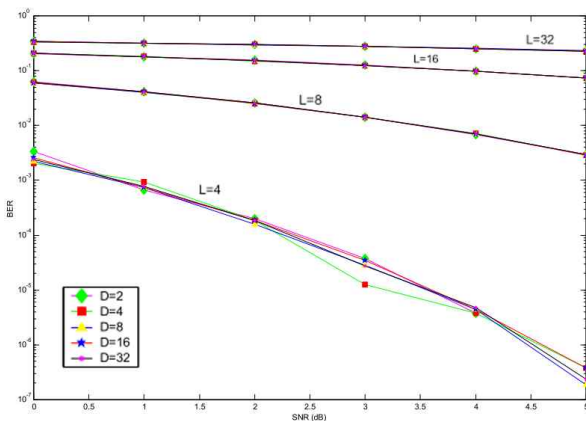

그림 9. M에 따라 달라지는 BER 성능  
Fig. 9. BER performance for M variation

### V. Conclusion

In this paper, we proposed a new modulation technique that combines AOCG and OFDM to overcome two critical problems of the conventional multi-code modulation: the shortage of the orthogonal codes and high PAPR. For this technique, the bit rate of the system can flexibly be changed in a large scale according to the four parameters:  $D$ ,  $N$ ,  $M$  and  $L$ . When  $N$ ,  $M$  and  $L$  are fixed, the data rate can increase in  $D$  without bandwidth expansion and performance degradation and it obtains  $M$  times that of the CMT. Moreover, if keeping the same condition as the CMT; which means  $D$  and  $N$  are unchanged, the data speed can vary according to  $M$  and  $L$  at the expense of performance decrease. Therefore, it is a promising modulation technique to be considered in the next generation of high-speed transmission systems on the demand of QoS.

## Reference

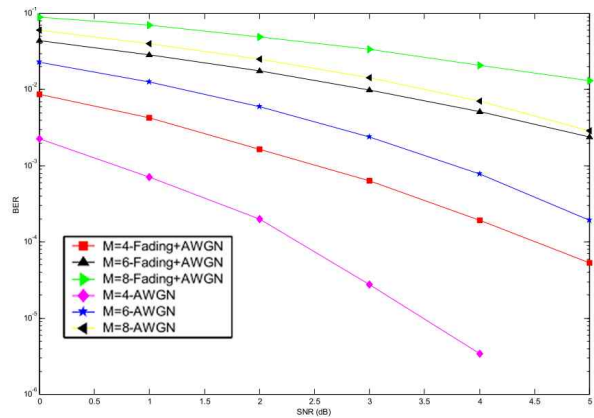
- [1] Hyung-Yun Kong, Il-Seung Woo, Kwang-Chun Ho "Design of New Multi-Code CDMA System Based on SOC Technique", Vol.E84-A No.12 p.3182~3186, *IEICE Transactions on Communication*, December, 2001.
- [2] N. Guo and L. B. Milstein, "On Sequence Sharing For Multi-Code Ds/Cdma Systems", MILCOM'98, October, 1998, Boston, USA, VOL.1, pp.238-242.
- [3] N. Iwakiri, "Evaluation of Multilayer High-speed Data Transmission based on Multi-code Technology", ICT'98, June, 1998, Porto Carras, Greece, VOL.1, pp.489-493.
- [4] Po-Wei Fu, Kwang-Cheng Chen, "Multi-rate MC-DS-CDMA with Multi-user Detections for Wireless Multimedia Communications", IEEE, 2002.
- [5] James K. Cavers, *Mobile Channel Characteristics*, Kluwer Academic Publishers, 2000.

## 저자 소개

공 형 윤(정회원)



- 1989년 2월 : New York Institute of Technology(미국) 전자공학과 학사
  - 1991년 2월 : Polytechnic University (미국) 전자 공학과 석사
  - 1996년 2월 : Polytechnic University (미국) 전자 공학과 박사
  - 1996년~1996년 : LG전자 PCS팀장
  - 1996년~1998년 : LG 전자 회장실 전략 사업단
  - 1998년~현재 : 울산대학교 전기전자정보시스템공학부 교수
- <주관심분야> 모듈레이션, 채널 부호화, 검파 및 추정 기술, 협력통신, 센서네트워크