

# A Design and Measurement of a Reference Signal Generator for a Radar System

Dong-Sik Kim<sup>1</sup> · Min-Chul Kim<sup>1</sup> · Su-Ho Lee<sup>1</sup> · Seung-Hun Baik<sup>1</sup> · Ho-Sang Kwon<sup>2</sup> · Myung-Deuk Jeong<sup>2</sup>

## Abstract

This paper discusses the design and fabrication of a reference signal generator for a naval radar system, including the vibration environment test. The transmit signals of the S-band radar system are synthesized by the reference signal and the phase noise must lower than  $-130$  dBc/Hz at a 10 kHz offset frequency. To achieve this specification, the phase noise of the reference signal needs to be less than  $-165$  dBc/Hz at a 10 kHz offset. For achieving very low phase noise performance by the reference signal generator, the phase locked loop technique is applied with a 10 Hz loop bandwidth. Also, this reference signal generator has  $\pm 0.35$  ppb short-term stability to minimize instant phase errors and high vibration sensitivity against a ship's shaking, unbalanced rotating of antennas and so on.

**Key words** : Radar System, Phase Noise, Spurious, Vibration, Stability.

## I. Introduction

In a radar system, the phase noise, the spurious noise and the frequency stability are the most important factors in determining a radar's performance. These factors include MTI(Moving Target Indicator), Doppler characteristics, coherency, clutter suppression, dynamic range and so on<sup>[1]~[5]</sup>. In addition, a radar system mounted on a ship must have high vibration sensitivity to reduce the noise caused by vibrations from the environment, such as the ship's shaking and the unbalanced rotating of antennas<sup>[6]~[8]</sup>. In this paper, the reference signal generator for a naval defense radar system is fully analyzed with respect to the electrical requirements and the vibration sensitivity. One major limiting factor for radar performance is the phase noise from the system signal source. Due to this phase noise, weak targets can be hidden by strong unwanted echoes, even if they are separated by Doppler shifts. This is especially critical in the case of small Doppler shifts as shown in Fig 1.

In order to satisfy the requirements of the radar system, a frequency signal source with a high degree of spectral purity is absolutely essential<sup>[9]</sup>.

Another important factor is the spurious signal. When this signal is within the unambiguous range, it will appear in the range profile and reduce the dynamic range of the receiver. Therefore, the spurious level beyond the signal must be suppressed below the level of the system's requirements. Also, frequency errors during the transmitting and receiving of a signal generate a phase error and degrade target resolution, so the short-

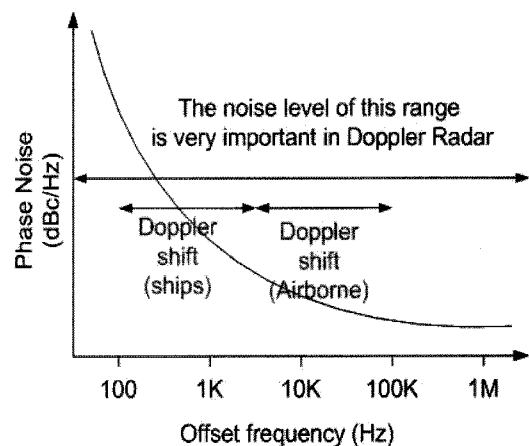

Fig. 1. Phase noise is an important factor in the Doppler radar system.

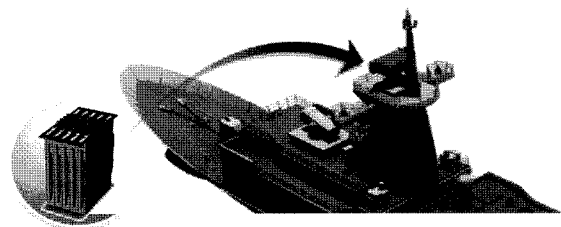

Fig. 2. Most parts of the radar system are positioned in the mast.

term stability of a reference signal is very important. As mentioned above, vibration sensitivity is an important specification for the oscillator, which is used on moving

Manuscript received June 17, 2009 ; revised August 28, 2009. (ID No. 20090617-024J)

<sup>1</sup>Department of Microwave Lab., LIGNex1, Yongin, Korea.

<sup>2</sup>Agency for Defense Development, Daejeon, Korea.

objects, especially ships, because most naval radar systems are positioned on the mast as shown in Fig. 2. In this paper, we show the phase noise performance in vibration conditions and the vibration sensitivities at each axis.

## II. Design and Fabrications

The block diagram of a reference signal represented in Fig. 3. Each Phase Locked Loop(PLL) block of the reference signal generator is divided into a primary channel and an auxiliary channel for emergency conditions. This has the function of monitoring the lock detection.

The specifications of the 10 MHz reference Oven Controlled Crystal Oscillator(OCXO) and the 80 MHz Voltage Controlled Oven Controlled Crystal Oscillator(VCOCXO) are described in Table 1. Since the phase noise of VCOCXO is better than that of the 10 MHz OCXO above 30 Hz, the loop bandwidth needs to be within 30 Hz so as not to degrade the phase noise performance.

The 80 MHz VCOCXO is locked onto the 10 MHz reference OCXO, which is referred to as PLL. It has the merit of phase noise and stability performances<sup>[10]</sup>.

The designed reference signal generator is shown in Fig. 4. The 10MHz reference OCXO is situated on the

Table 1. Specifications of oscillators.

		OCXO	VCOCXO
Frequency(MHz)		10	80
Phase noise	dBc/Hz@10 Hz	-120	-100
	dBc/Hz@100 Hz	-150	-130
	dBc/Hz@1 kHz	-160	-158
	dBc/Hz@10 kHz	-165	-174
	dBc/Hz@100 kHz	-165	-174

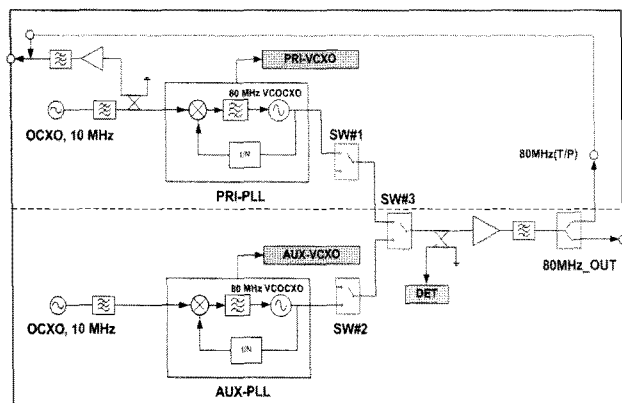
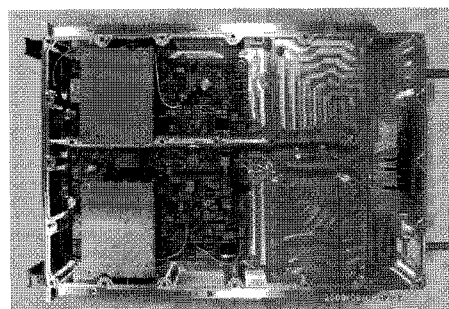
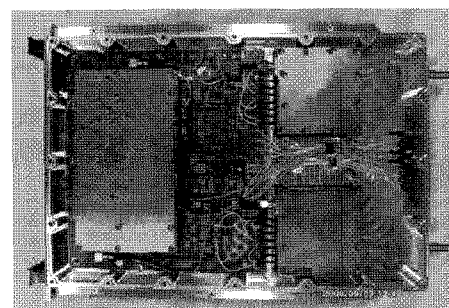

Fig. 3. Block diagram of the reference signal generator.



(a) Top view



(b) Bottom view

Fig. 4. Designed reference signal generator.

top side as in(a) and the PLL part, including 80 MHz VCOCXO, is configured as shown in (b).

This unit was designed as a vibration-proof structure with high vibration sensitivity by spacing each component symmetrically. It is noteworthy that the designed unit shows high vibration immunity, good frequency stability and very low noise performance.

## III. Measurements

### 3-1 Phase Noise Characteristics

Results of the phase noise and spurious level of the 80 MHz output signal are shown in Fig. 5. Measurements were performed by using the Agilent E5052B Signal Source Analyzer, which has single side band(SSB) phase noise sensitivity of -178 dBc/Hz at a 100 kHz offset frequency. The measured phase noise is -167 dBc/Hz at a 10 kHz offset and that of the second harmonic is -70.3 dBc.

Table 2 shows that the measured results satisfy the requirements for the reference signal generator.

### 3-2 Frequency Stability Characteristics

The frequency stability affects system coherency and degrades the resolution that reduces the probability of detection of the radar and the accuracy of distance measuring devices. Frequency stability is mostly affected by

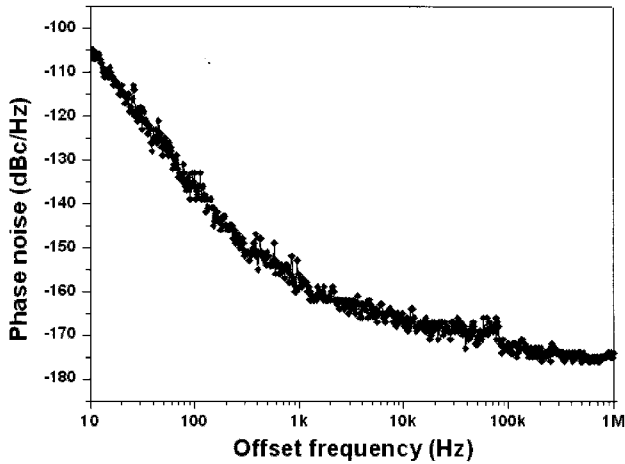

(a) Phase noise measurement

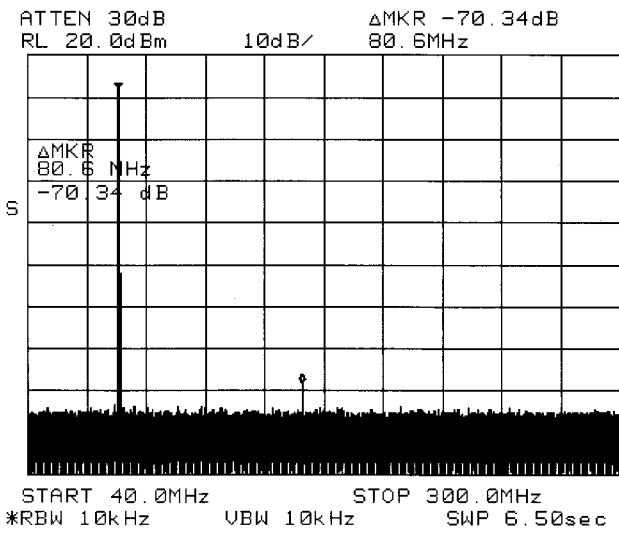

(b) Spurious level measurement

Fig. 5. Measurement results of the phase noise and the spurious level.

Table 2. Specifications and measurements of the reference signal generator.

		Spec.	Measurement
Frequency(MHz)		80	80
Power(dBm)		10±1	10.1
Harmonic(dBc)		-60	-70.3
Phase noise	dBc/Hz@100 Hz	-125	-139
	dBc/Hz@1 kHz	-145	-157
	dBc/Hz@10 kHz	-165	-167
	dBc/Hz@100 kHz	-170	-173

the reference oscillator and the loop bandwidth in the phase locked loop.

There are several methods for estimating the fre-

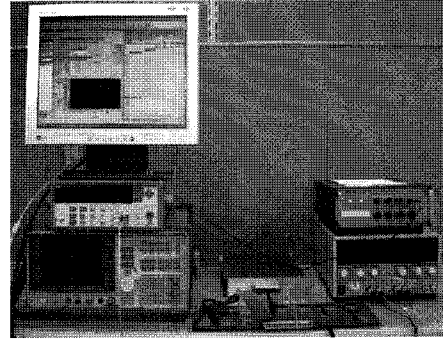

Fig. 6. The measurement setup for the frequency stability.

quency stability of the signal<sup>[11]</sup>. In practice, the root Allan variance is used for the short-term stability and is described in equation (1).

$$\sigma_y(\tau) = \sqrt{\frac{\sum_{i=1}^{n-1} (X_{i+1} - X_i)^2}{2(n-1)}} \quad (1)$$

where,

y=fractional frequency deviation

τ=measurement time for each frequency reading

X<sub>n</sub>=frequency reading

n=number of frequency readings

The measurement setup for the short-term stability is shown in Fig. 6. The frequency stability is measured by using an Agilent 53131A frequency counter and an Agilent VEE Pro 7.5. Fig. 7 plots the output frequency generated by the phase locked loop. It is measured as the real time frequency per second of the PLL output signal for 10 minutes after the power is turned on. The output frequency is stabilized to 80 MHz after 5 minutes for warming up the VCOCXO and Fig. 8 shows the calculated result of the accumulated Allan variance after warming the VCOCXO by equation (1).

The estimated Allan variance of the 80 MHz output frequency is 0.35 ppb after stabilizing and the stabilized frequency after VCOCXO warming is 80000006.34 Hz.

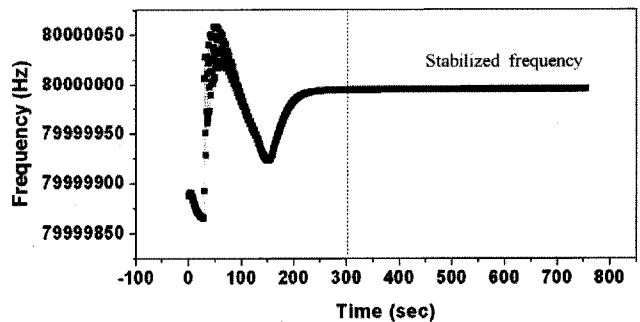

Fig. 7. Output frequency of the reference signal generator for about 10 minutes.

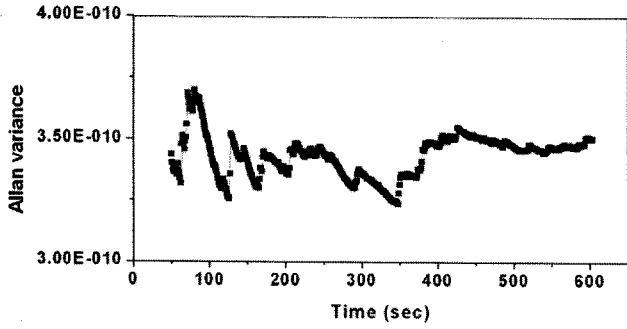

Fig. 8. Frequency stability estimates by the Allan variance, which is derived from equation (1).

So, the initial frequency accuracy of the 80 MHz output signal is about 0.08 ppm.

### 3-3 Vibration Tests

In general, shipboard equipments must have high vibration sensitivity against operational vibration conditions. The vibration power spectral density profile is shown in Table 3. This is defined in mil-std 167-1A<sup>[6]</sup>. The designed reference signal generator was fabricated for a naval radar system where military standards must be met.

Fig. 9 shows the reference signal generator mounted on the vibration platform. The selected vibration platform is the V860-HD-C by Ling Dynamic System. The vibration performance is measured on three orthogonal

Table 3. Vibratory displacement of environmental vibration for mast-mounted equipment.

Frequency range(Hz)	Table single amplitude(inch)
4 to 10	0.100±0.010
11 to 15	0.030±0.006
16 to 25	0.020±0.004
26 to 33	0.010±0.002

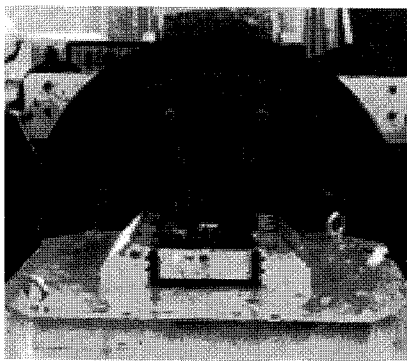
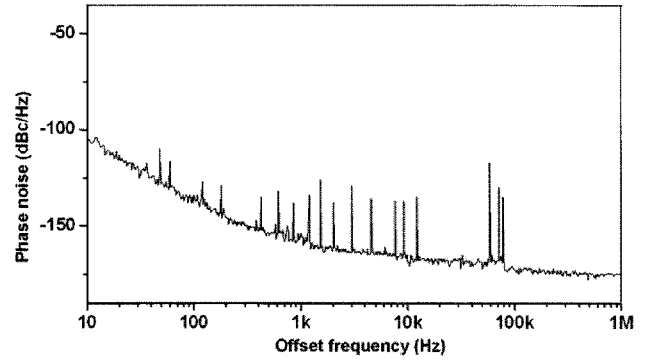
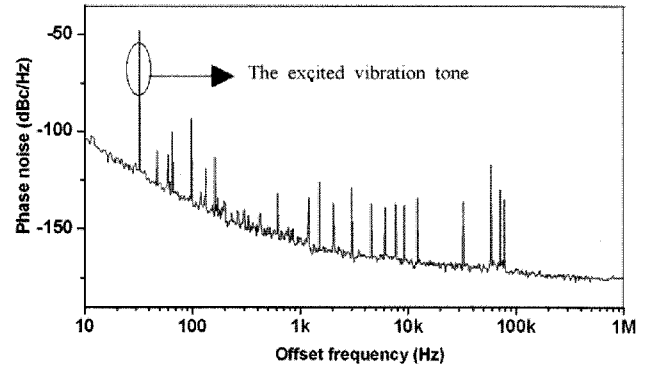

Fig. 9. The reference signal generator on the vibration test facility.



(a) Phase noise of before the test



(b) Phase noise of during the test

Fig. 10. Phase noise measurements of the x-axis in the vibration conditions with a 33 Hz frequency.

axes to determine the vibration sensitivity.

Fig. 10 shows the phase noise results in vibration conditions. The blue line is the pre-test results and the red line represents results during the test with vibration along the x-axis. As a result, the vibration has no effect on the phase noise curve, but the excited vibration tone appears in the phase noise spectrum related to the vibration sensitivity.

The vibration sensitivity on the specific axis can be expressed as the fractional frequency change due to sinusoidal acceleration.

$$\Gamma_i = \frac{2f_v}{a f_a} 10^{\left[ \frac{L(f_v)}{20} \right]} \quad (2)$$

$f_v$  : Offset frequency(the frequency of the vibration tone)

$f_a$  : The carrier frequency

$a_i$  : The vibration magnitude determined by the accelerometer output

$L(f_v)$  : The magnitude of the rms phase tone measured from the SSB phase noise plot

The vibration sensitivity of 33 Hz vibration tone on the x-axis is calculated as follows.

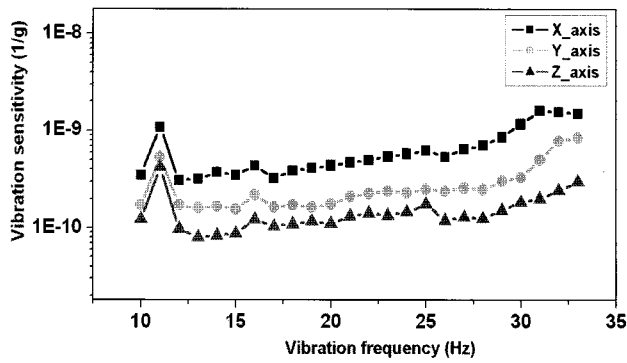

Fig. 11. Vibration sensitivity of each axis from 10 Hz to 33 Hz.

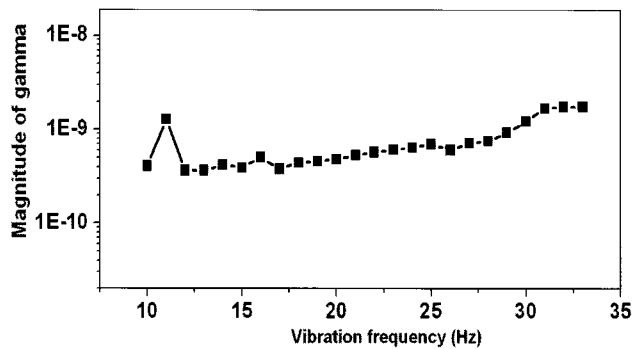

Fig. 12. Vibration sensitivity of the reference signal generator.

$$\begin{aligned}
 f_v &= 30 \text{ Hz} \\
 a_i &= 1.8 \\
 f_a &= 80 \text{ MHz} \\
 L(f_v) &= -51 \text{ dBc/Hz}
 \end{aligned}$$

So, derived.

$$\Gamma_{x-33Hz} = 1.17 \times 10^{-9}$$

Fig. 11 shows the vibration sensitivity of the reference signal generator along the X, Y and Z directions.

The vibration tones were excited from 10 Hz to 33 Hz and their magnitudes were measured from the SSB phase noise plot. The vibration sensitivity was derived by equation (2) in the X, Y and Z directions respectively. Combining the vibration sensitivity on each axis gives gamma, which means the vibration sensitivity of the reference signal generator. The magnitude of gamma is shown in equation (3).

$$|\Gamma| = \sqrt{\Gamma_x^2 + \Gamma_y^2 + \Gamma_z^2} \tag{3}$$

The calculated gamma for the reference signal generator is shown in Fig. 12.

The vibration sensitivity(gamma) of the reference signal generator is about  $7.51 \times 10^{-10}/g$ .

#### IV. Conclusion

In this paper, we showed that the proposed reference signal generator has good noise performance, including short-term stability and vibration sensitivity.

In a radar system, MTI, clutter suppression and resolution are very important characteristics. The frequency synthesizer and the reference oscillator make the main contributions to these results. Since the transmit signal is synthesized from an 80MHz reference signal, this reference signal should have low noise performance and good stability.

The designed reference signal generator exploits the PLL system to achieve the phase noise specification of the S-band transmit signal and to satisfy the need for short-term stability. Also, naval radar systems are exposed to vibrations such as the ship's shaking and the antennas' rotation. Therefore, equipment mounted on ships needs to have sufficient vibration sensitivity.

From these results, we showed that this reference signal generator provides good performance and can be used in naval radar systems.

#### References

- [1] J. J. Stagliano, Jr. J. Helvin, J. L. Alford, and D. Nelson, "Phase noise, coherency, and clutter suppression", *32nd Conference on Radar Meteorology*, Jan. 2005.
- [2] W. Tao, T. Xiaohong, X. Fei, "Research on the effect of frequency synthesizer on the performance of MMW stepped frequency radar", *GSMM 2008 Proceeding*, 2008.
- [3] B. J. Harker, Z. Dobrosavljevic, E. P. Craney, C. M. Tubbs, and G. L. Harris, "Dynamic range improvements and measurements in radar systems", *Radar, Sonar & Navigation, IET*, pp. 398-406, Dec. 2007.
- [4] M. Skolnik. *Introduction to Radar systems*, 3rd edition, McGraw Hill, pp. 149-197, 2001.
- [5] B. J. Harker, "Dynamic range enhancements in radar systems", *2nd EMRS DTC Technical Conference*, Edinburgh, 2005.
- [6] Department of Defense Test Method Standard, Mechanical Vibration of Shipboard Equipment, MIL-STD-167-1A, Nov. 2005. URL: <http://assist.daps.dla.mil>.
- [7] T. Wallin, L. Josefsson, and B. Lofter, "Phase noise performance of sapphire microwave oscillators in airborne radar systems", *GigaHertz2003, Proceedings from the Seventh Symposium*, Nov. 2003.
- [8] S. Huang, M. Tu, S. Yao, and L. Maleki, "A turn-key optoelectronic oscillator with low acceleration

sensitivity", *IEEE/EIA International Frequency Control Symp.*, pp. 269-279, 2000.

- [9] P. Stockwell, C. McNeilage, M. Mossammaparast, D. M. Green, and J. H. Searls, "3-axis vibration performance of a compact sapphire microwave oscillator", *IEEE International Frequency Control Symposium*, Jun. 2001.

- [10] B. G. Goldberg, *Digital Frequency Synthesis Demystified*, LLH Technology Publishing, 1999.

- [11] C. A. Greenhall, "Frequency stability review", *The Telecommunications and Data Acquisition Report*, pp. 200-212, Feb. 1987.

**Dong-Sik Kim**



received B.S. degree from Kwangwoon University, Seoul, Korea, in 2000 and M.S. degree in electronics engineering from the Yonsei University in 2005. In 2000, he joined Samsung electro-mechanics Ltd., Suwon, as a research engineer. In 2005, he joined SK teletech Ltd., Seoul, as a research engineer. Since 2007, he has been

working at the microwave center in LIG Nex1. His research interests include phase locked loop, frequency synthesizer, microwave active circuit design and radar system.

**Seung-Hun Baik**



received the B.S., M.S. degrees in the dept. of electronic and electrical engineering from Sogang University, Seoul, Korea in 1986. Currently, he is a chief research engineer at the microwave center in LIG Nex1. His research interests include passive/active antenna and active phased array radar design.

**Min-Chul Kim**



received the B.S. degree from Sungkyunkwan University, Gyeong-do, Korea, in 2005 and the M.S. degree in dept of electronics engineering from Seoul National University, Seoul, Korea, in 2007. Currently, he is a research engineer at the microwave center in LIG Nex1. His research interests include frequency synthesizer, microwave

active circuit design and radar system.

**Ho-Sang Kwon**

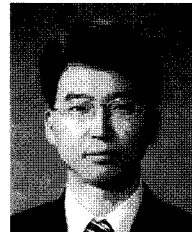

received the B.S., M.S. degrees in the dept. of electronics engineering from Kyungpook National University, Daegu, Korea in 1995 and 1997. During 1997~1999, he worked in Daewoo electronics, Ltd. Since 1999, he has been working at the Agency for Defense Development, where he is currently a senior researcher. His

research interests include radar transmitter and receiver system design.

**Su-Ho Lee**



received the B.S., M.S. from Inha University, Incheon, Korea in 1992. Currently, he is a chief research engineer at the microwave center in LIG Nex1. His research interests include microwave passive/active circuit and active phased array radar design.

**Myung-Deuk Jeong**



received the Ph.D. degree in the dept. of electronics engineering from Chungnam National University, Daejeon, Korea in 2003. Since 1991, he has been working at the Agency for Defense Development, where he is currently a principal researcher. His research interests include active phased array radar systems.