

A Comparison of TDMA, Dirty Paper Coding, and Beamforming for Multiuser MIMO Relay Networks

Jianing Li, Jianhua Zhang, Yu Zhang, and Ping Zhang

Abstract: A two-hop multiple-input multiple-output (MIMO) relay network which comprises a multiple antenna source, an amplify-and-forward MIMO relay and many potential users are studied in this paper. Consider the achievable sum rate as the performance metric, a joint design method for the processing units of the BS and relay node is proposed. The optimal structures are given, which decompose the multiuser MIMO relay channel into several parallel single-input single-output relay channels. With these structures, the signal-to-noise ratio at the destination users is derived; and the power allocation is proved to be a convex problem. We also show that high sum rate can be achieved by pairing each link according to its magnitude. The sum rate of three broadcast strategies, time division multiple access (TDMA) to the strongest user, dirty paper coding (DPC), and beamforming (BF) are investigated. The sum rate bounds of these strategies and the sum capacity (achieved by DPC) gain over TDMA and BF are given. With these results, it can be easily obtained that how far away TDMA and BF are from being optimal in terms of the achievable sum rate.

Index Terms: Broadcast strategy, multiuser relay networks, sum rate.

I. INTRODUCTION

The future generation wireless systems are envisaged to offer ubiquitous high data rate coverage in large areas. Cooperative transmission [1], [2] has recently gained a lot of interest to achieve this goal. The core idea is to introduce relay nodes [3] to assist data packets transmission between the source and the destination.

Prior works [2], [4] mainly focus on cooperative transmission in the non-centralized network, where the role of the source, destination, and relay are all performed by mobile terminals, i.e., "user cooperative." However, in cellular systems, it is likely only a few infrastructure relays will be available, e.g., use pre-located relay station to boost coverage and link capacity in regions with significant shadowing [1]. Consequently, each relay node will need to support multiple users. This is the motivation to study the point-to-multipoint relay channels, where the fixed relay stations have some signal processing abilities to benefit the transmission in terms of high data rate and wide coverage. A natural solution is to exploit the multiple-input multiple-output (MIMO) technology [5].

Manuscript received December 17, 2007.

The authors are with the Wireless Technology Innovation Institute (WTI), Telecommunications Engineering Department, Beijing University of Posts and Telecommunications. Key Laboratory of Universal Wireless Communication, Ministry of Education, email: {lijianing, zhangjianhua, zhangyu, zhangping}@mail.wtilabs.cn.

This work was supported by Electronics and Telecommunications Research Institute (ETRI), Korea, the National 863 Projects, China (No. 2006AA01Z283) and National Natural Science Foundation of China (60772113).

The spatial multiplexing in the MIMO relay channel has been studied in [6]–[8] by considering a single source destination pair. In this paper, we focus on the sum rate [9] issue in MIMO relay broadcast channel with time division multiple access (TDMA) to the strongest user, dirty paper coding (DPC), and beamforming (BF) strategies, which define the sum of the coding rates intended to the downlink users with vanishing decoding error probability as the coding block length grow. In the conventional MIMO broadcast channel (BC), the TDMA sum rate is known to be the largest channel norm user capacity. The sum rate capacity can be achieved by using DPC [10] and media access control-BC (MAC-BC) duality [11], [12] in the multiuser MIMO BC. Assigning different beamforming directions for users and treating multiuser interference as noise, BF is a sub-optimal technique for supporting multiuser transmission, which has reduced complexity relative to DPC. Although the sum rate of these broadcast strategies is well known for the MIMO broadcast channel [13], it is not cleared for the multiuser MIMO relay channel. To solve this problem, a joint design method is proposed, which expresses the sum rate of MIMO relay channel as the function of the processing matrices at the base station (BS) and relay. We derive the received signal-to-noise ratio (SNR) of the cooperative MIMO relay channel, and prove that the optimal power allocation of the BS and relay is a standard convex optimization problem [14]. Denoting the sum rate achieved by DPC as the sum capacity of the MIMO relay BC channel, the gain over TDMA and BF are given. The motivation is to obtain that how much of a performance boost DPC provides over the other two strategies in the multiuser MIMO relay channel. The multiuser MIMO relay channel is first introduced in [15], where the zero-forcing DPC (ZF-DPC) is used to derive the sum rate. In this paper, we extend this model to a common scenario with considering the direct link between the source and the destination users.

The paper is organized as the following. In Section II, we present the system model and main assumptions. A brief review of MIMO BC strategies is also given. The joint design method and the optimal processing structures for the single user MIMO relay channel are proposed in Section III, these results are extent to the multiuser case in Section IV by applying different BC strategies, and the sum rate comparisons are also given, both in the fixed gain and Rayleigh fading channel. Finally, the numerical results are presented to demonstrate the analysis.

Notation: Throughout this paper, bold upper letter is used to denote matrices and bold lower letter to denote vectors. For a matrix \mathbf{X} , the superscripts $(\cdot)^T$ and $(\cdot)^H$, stand for transposition and conjugate transposition, the subscripts i , j stand for the i th row the j th column entry. Tr denotes the trace. E denotes the expectation operator.

II. SYSTEM MODEL AND BC STRATEGY

A. System Model and Main Assumptions

The infrastructure MIMO relay station which supports multi-user transmission in a downlink cellular system is shown in Fig. 1. Assuming multiple relays transmit on the orthogonal channels, i.e., frequency division multiple access, the focus can be shifted on a single relay station mode.

Data packets are broadcasted from the BS with n_t antennas to K potential users each with m receive antennas, by the assistance of a fixed relay station with n_r antennas. We assume that $n_t \geq n_r \geq m$ which the typical values of the cellular system are.

Although the full duplex relay [6] can achieve better capacity, it is difficult to have the nodes transmit and receive simultaneously in the same frequency. Thus, the investigation is restricted to the orthogonal relay transmission, i.e., TDM relaying. The data packets transmission occupies two equal length time slots. In the first time slot, the BS broadcasts the signal to the desired users and relay. In the second time slot, relay re-transmits the signal to users after proper processing and the source keeps silent. The destination maximal ratio combining (MRC) combines the delayed buffered signal received in the first time slot with the new version from the relay in the second time slot. Our discussion is based on the analog non-regenerative (amplify-and-forward) relaying mode, where the information data are not regenerated at the relay except that the baseband symbols are reproduced. Additional, all the terminals in the network are assumed to be perfectly synchronized.

The $n_r \times n_t$ MIMO channel \mathbf{H}_1 is created for the BS-relay link, $\mathbf{H}_0 = [\mathbf{H}_{0,1}^T, \mathbf{H}_{0,2}^T, \dots, \mathbf{H}_{0,K}^T]^T$ is the multiuser broadcast channel for the BS-users' link, where $\mathbf{H}_{0,k}$ is the $m \times n_t$ channel matrix from the BS to the k th user. $\mathbf{H}_2 = [\mathbf{H}_{2,1}^T, \mathbf{H}_{2,2}^T, \dots, \mathbf{H}_{2,K}^T]^T$ is the multiuser relay channel between the relay and users, where $\mathbf{H}_{2,k}$ is the $m \times n_r$ channel matrix between the relay and the k th user. During the two time slots transmission, \mathbf{H}_0 , \mathbf{H}_1 , and \mathbf{H}_2 are assumed to remain constant. The channel state information (CSI) is known perfectly at the two terminals of each link, it means that the BS has the CSI of \mathbf{H}_0 and \mathbf{H}_1 , the relay knows \mathbf{H}_1 and \mathbf{H}_2 , the user knows $\mathbf{H}_{1,k}$ and $\mathbf{H}_{2,k}$.

B. Signal Model and Problem Formulation

An $n_t \times n_t$ linear processing matrix \mathbf{F} is used to process the transmitted signal \mathbf{s} as $\mathbf{x}_S = \mathbf{F}\mathbf{s}$, and an $n_r \times n_r$ matrix \mathbf{W} is used to process the re-transmitted signal \mathbf{y}_R at the relay. The received signal in the first time slot at the relay and the k th destination user can be written as

$$\begin{aligned} \mathbf{y}_R &= \mathbf{H}_1 \mathbf{F} \mathbf{s} + \mathbf{n} \\ \mathbf{y}_k^{TS1} &= \mathbf{H}_{0,k} \mathbf{F} \mathbf{s}_k + \sum_{j=1, j \neq k}^K \mathbf{H}_{0,k} \mathbf{F} \mathbf{s}_j + \mathbf{n}. \end{aligned} \quad (1)$$

The relay station normalizes, processes and re-transmits the signal by processing matrix \mathbf{W} . Without loss of any generality, let

$$\mathbf{W} = \tilde{\mathbf{W}} \Xi^{-1/2} \quad (2)$$

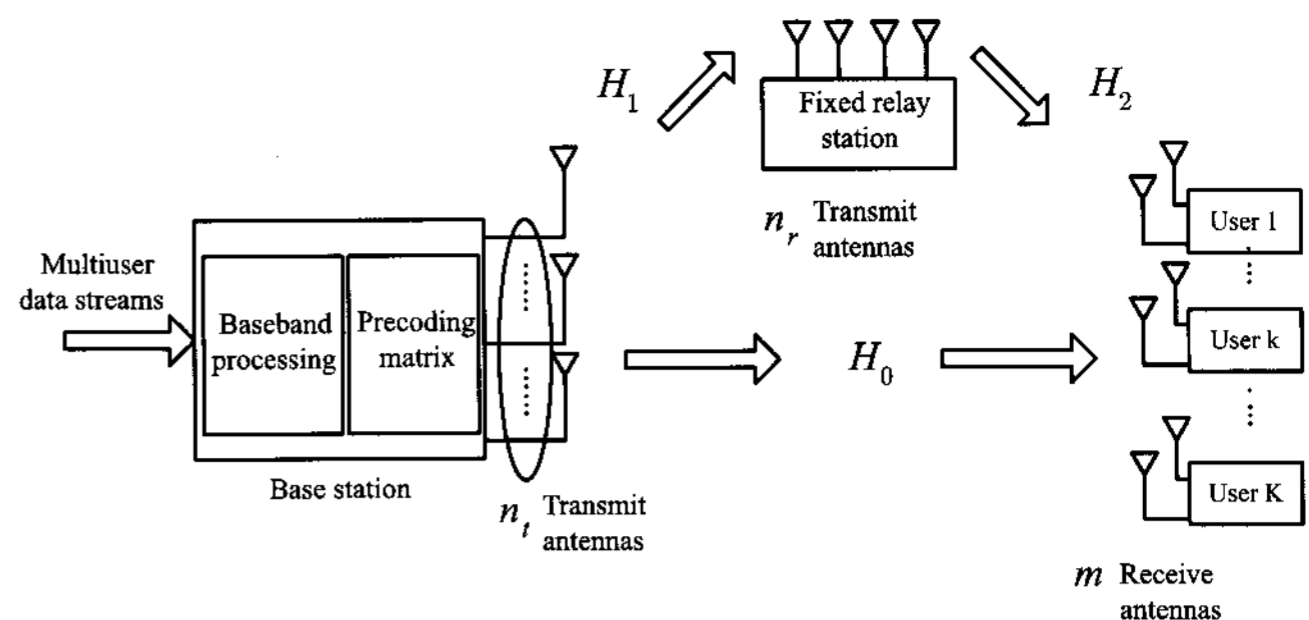

Fig. 1. System model of multiuser MIMO relay channel.

where Ξ satisfied $Tr\{\Xi\} = Tr\{\mathbf{H}_1 \mathbf{F} \mathbf{F}^H \mathbf{H}_1^H + \mathbf{I}\}$ is used to normalize the received signal from the source. Then, the received signal in the second time slot at the destination user is

$$\mathbf{y}_k^{TS2} = \mathbf{H}_{2,k} \mathbf{W} \left(\mathbf{H}_{1,k} \mathbf{F} \mathbf{s}_k + \sum_{j=1, j \neq k}^K \mathbf{H}_{1,k} \mathbf{F} \mathbf{s}_j + \mathbf{n} \right) + \mathbf{n} \quad (3)$$

where $\mathbf{s} = [s_1, \dots, s_K]^T$ is the zero mean circularly symmetric complex Gaussian vector with $E\{s s^H\} = 1$, and s_k is the $m \times 1$ desired signal for the k th user. \mathbf{n} is the additive white Gaussian noise (AWGN) noise.

Thus, the received SNR at the k th user is a function of \mathbf{F} and \mathbf{W} as $\gamma_k(\mathbf{F}, \mathbf{W})$, and the achievable sum rate problem can be formulated as

$$\begin{aligned} R &= \max_{\{\mathbf{F}, \mathbf{W}\}} \sum_{k=1}^K \frac{1}{2} C(\gamma_k(\mathbf{F}, \mathbf{W})) \\ \text{subject to } &\begin{cases} Tr\{\mathbf{F} \mathbf{F}^H\} \leq P_S \\ Tr\{\mathbf{W} (\mathbf{H}_1 \mathbf{F} \mathbf{F}^H \mathbf{H}_1^H + \mathbf{I}) \mathbf{W}^H\} \leq P_R \end{cases} \end{aligned} \quad (4)$$

where $C(\gamma)$ denotes the Shannon capacity as $C(\gamma) = \log(1 + \gamma)$, and $1/2$ accounts for the capacity loss due to two time slots transmission. We omit this prefix for the simplicity reason in the remaining part and focus on $C(\gamma_k(\mathbf{F}, \mathbf{W}))$, P_S and P_R are the power constraints at the BS and relay, respectively.

C. Review of MIMO Strategy

In TDMA scheme, the BS transmits to only a single user at a time. The maximum sum rate, achieved by sending to the user with the largest channel norm is

$$R = \max_{k \in K} \log \det \left(1 + P_S \|\mathbf{H}_k\|^2 \right). \quad (5)$$

The DPC has been known as the capacity-achieving strategy for a Gaussian MIMO BC. However, it may not be directly implemented due to its excessively high complexity. ZF-DPC based on Tomlinson-Harashima (TH) precoding and QR decomposition, has been proposed as a low complexity sub-optimal transmission methods. Let \mathcal{S} be the receiver subset and $\mathbf{H}(\mathcal{S})$ is the corresponding channel matrix. Taking QR decomposition as $\mathbf{H}(\mathcal{S}) = \mathbf{R}\mathbf{Q}$, where \mathbf{Q} is a unitary matrix and \mathbf{R} is a lower

triangular matrix. Choosing Q^H as the precoding at the transmitter, the effective channel R can be diagonalized by using TH precoding. Denoting the diagonal elements of R be $r_{i,i}$, and using waterfilling algorithm on $r_{i,i}$, the sum rate with ZF-DPC is

$$R = \max \sum_{i \in S} \log(1 + p_i |r_{i,i}|^2). \quad (6)$$

The block-diagonal (BD) beamforming is a linear method for the multi-antenna receivers. The respective data stream of each user can be decoupled and send without interfering with other users. Let $\tilde{H}_j = [H_1^T, \dots, H_{j-1}^T, H_{j+1}^T, \dots, H_K^T]^T$. In order to satisfy the zero interference constraint, the beamforming matrix of the j th user shall be in the null space of \tilde{H}_j . Let the singular value decomposition (SVD) of \tilde{H}_j be $\tilde{H}_j = \tilde{U}_j \tilde{\Lambda}_j [\tilde{V}_j^1 \tilde{V}_j^0]^H$, \tilde{V}_j^0 contains the last $(n_t - m)$ right singular vectors of \tilde{H}_j which form a basis set in the null space of \tilde{H}_j . Same with ZF-DPC, let S be a user subset, the sum rate with BD is

$$R = \max \sum_{j \in S} \log \det \left| I + (H_j \tilde{V}_j^0)(H_j \tilde{V}_j^0)^H \right|. \quad (7)$$

III. OPTIMAL RELAY STRUCTURE AND ACHIEVABLE SUM RATE

In this section, we derive the optimal structures for the single user MIMO relay channel; and extend the result to the multiuser case with different broadcasting strategies in the next section. According to the signal model given in (1) and (3), the input-output relationship of the single user MIMO relay channel can be written as

$$\begin{aligned} \mathbf{y} &= H\mathbf{x} + N \\ &= \begin{pmatrix} H_0 \\ H_2 W H_1 \end{pmatrix} \mathbf{x}_S + \begin{pmatrix} I & 0 & 0 \\ 0 & H_2 W & I \end{pmatrix} \begin{pmatrix} \mathbf{n} \\ \mathbf{n} \\ \mathbf{n} \end{pmatrix}. \end{aligned} \quad (8)$$

The noise covariance is

$$\mathcal{R}_N = \begin{pmatrix} I & 0 \\ 0 & I + (H_2 W)(H_2 W)^H \end{pmatrix}. \quad (9)$$

Using the block matrix inverse lemma and the determinant of block matrix lemma, the mutual information can be written as

$$\begin{aligned} I &= \log \det (H^H \mathcal{R}_N^{-1} H) \\ &= \log \det (I + \tilde{H}_0 \tilde{H}_0^H) \\ &\quad + \log \det \left(\begin{array}{c} I + \tilde{H}_1 (I + \tilde{H}_0 \tilde{H}_0^H)^{-1} \tilde{H}_1^H - \tilde{H}_1 \\ \times (I + \tilde{H}_0 \tilde{H}_0^H)^{-1} (I + \tilde{H}_2 \tilde{H}_2^H)^{-1} \tilde{H}_1^H \end{array} \right) \end{aligned} \quad (10)$$

where $\tilde{H}_0 = H_0 F$, $\tilde{H}_1 = H_1 F$, $\tilde{H}_2 = H_2 W$. The mutual information in (10) is constituted by two parts, the first is the mutual information of the direct link; the second is the mutual information of the relay link, which trades the signal of the direct link as noise and minus the loss of the second hop.

According to (1) and (3), the optimal processing structure at the BS and relay under the ZF constraint is to diminish the multi-user interference and maximize the mutual information. Since we assume no CSI of the direct link is available at the relay, there is no W can diagonal the second term of the RHS in (10), i.e., the optimal relay structure only exists when the processing matrix F projects the relay link onto the orthogonal space of the direct link. To accomplish this, define the SVD of H_1 and H_0 as

$$\begin{aligned} H_1 &= U_1 \Sigma_1^{1/2} [V_1 \ V_1^{(0)}]^H \\ H_0 &= U_0 \Sigma_0^{1/2} [V_0 \ V_0^{(0)}]^H \end{aligned}$$

where $V_1^{(0)}$ and $V_{0,k}^{(0)}$ are the $n_t \times m$ and $n_t \times n_r$ matrices hold $(n_t - m)$ and $(n_t - n_r)$ right singular vectors, which form the orthogonal basis for the null space of H_0 and H_1 . Thus, its columns can be the candidate for the processing matrix of the BS. Then, F can be written as

$$F = F_1 \tilde{F} \quad (11)$$

where $F_1 = [V_0^{(0)} \ V_1^{(0)}]$. Since F_1 is a unitary matrix, the power constraint does not violate. Note this method is also employed in [16] for the MIMO downlink transmission to obtain the beamforming matrix for the multi-antenna receivers. Then, the downlink channel can be converted to two parallel MIMO channels as $\tilde{H}_1 = H_1 V_1^{(0)}$ and $\tilde{H}_0 = H_0 V_1^{(0)}$. The sufficient condition here for the existence of F_1 is $n_t \geq (n_r + m)$. Then, the mutual information given in (10) can be written as

$$\begin{aligned} I &= \log \det (I + \tilde{H}_0 \tilde{F} \tilde{F}^H \tilde{H}_0^H) \\ &\quad + \log \det (I + \tilde{H}_1 \tilde{F} \tilde{F}^H \tilde{H}_1^H) \\ &\quad + \log \det \left(I + \frac{H_2 \tilde{W} \tilde{W}^H H_2^H}{I + \tilde{H}_1 \tilde{F} \tilde{F}^H \tilde{H}_1^H + H_2 \tilde{W} \tilde{W}^H H_2^H} \right). \end{aligned} \quad (12)$$

Since the BS has no CSI of H_2 , the optimal processing matrix at the BS from the mutual information point-of-view is to maximize the first two terms in (12). Defining the SVD of \tilde{H}_1 and \tilde{H}_0 as $\tilde{H}_1 = \tilde{U}_1 \tilde{\Sigma}_1^{1/2} \tilde{V}_1^H$, $\tilde{H}_0 = \tilde{U}_0 \tilde{\Sigma}_0^{1/2} \tilde{V}_0^H$, where $\tilde{\Sigma}_1 = \text{diag}\{\bar{\alpha}_1, \dots, \bar{\alpha}_{n_r}\}$ and $\tilde{\Sigma}_0^{1/2} = \text{diag}\{\bar{\xi}_1, \dots, \bar{\xi}_m\}$ contain the eigenvalues of \tilde{H}_1 and \tilde{H}_0 . Let

$$\begin{aligned} F &= F_1 F_2 P^{1/2} \\ &= [V_0^{(0)} \ V_1^{(0)}] \begin{bmatrix} \tilde{V}_1 & 0 \\ 0 & \tilde{V}_0 \end{bmatrix} \begin{bmatrix} P_1^{1/2} & 0 \\ 0 & P_0^{1/2} \end{bmatrix} \end{aligned} \quad (13)$$

where P is the power allocation matrix to satisfy the power constraint. Then, the downlink channel of the BS can be converted into several single-input single output (SISO) channels, and the optimal $P = \text{diag}\{P_1, P_2\}$ is weighted by waterfilling on the eigenvalues of \tilde{H}_0 and \tilde{H}_1 as

$$p_{1,i} = \left(\mu - \frac{1}{\bar{\alpha}_i} \right)^+ \quad p_{0,i} = \left(\mu - \frac{1}{\bar{\xi}_i} \right)^+ \quad (14)$$

where $\bar{\alpha}_i$ and $\bar{\xi}_i$ are the i th eigenvalue of H_0 and H_1 , μ is a constant scale to satisfy the power constraint of the BS, $(x)^+ =$

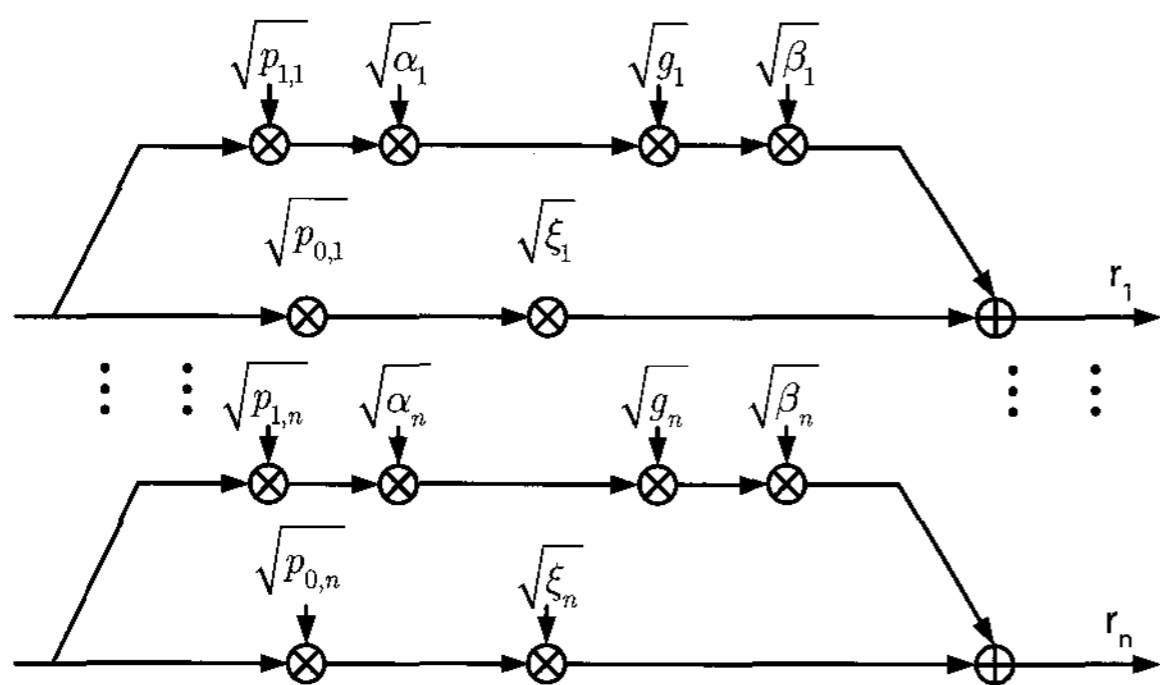

Fig. 2. Equivalent SISO relay channel.

$\max(x, 0)$. Thus, the mutual information given in (12) can be written as

$$I = \log \det (\mathbf{I} + \mathbf{P}_0 \bar{\boldsymbol{\Sigma}}_0) + \log \det (\mathbf{I} + \mathbf{P}_1 \bar{\boldsymbol{\Sigma}}_1) + \log \det \left(\mathbf{I} + \frac{\mathbf{H}_2 \tilde{\mathbf{W}} \tilde{\mathbf{W}}^H \mathbf{H}_2^H}{\mathbf{I} + \mathbf{P}_1 \bar{\boldsymbol{\Sigma}}_1 + \mathbf{H}_2 \tilde{\mathbf{W}} \tilde{\mathbf{W}}^H \mathbf{H}_2^H} \right). \quad (15)$$

Let the SVD of \mathbf{H}_2 as $\mathbf{H}_2 = \mathbf{U}_2 \boldsymbol{\Sigma}_2^{1/2} \mathbf{V}_2^H$ where $\boldsymbol{\Sigma}_2 = \text{diag}\{\beta_1, \dots, \beta_{n_r}\}$ contain the eigenvalues of \mathbf{H}_2 . According to [7], the optimal structure of $\tilde{\mathbf{W}}$ is to diagonalize \mathbf{H}_2 as

$$\tilde{\mathbf{W}} = \mathbf{V}_2 \mathbf{G}^{1/2} \bar{\mathbf{U}}_1^H \quad (16)$$

where $\mathbf{G} = \text{diag}\{g_1, \dots, g_{n_r}\}$ is the transmit power of the relay. $\tilde{\mathbf{W}}$ can be viewed as a spatial filter which decomposes the MIMO relay channel into several SISO links, rotates and adjusts the eigenvalues of two hop channel. Then, the optimal processing unit at the relay node can be written as

$$\mathbf{W} = \mathbf{V}_2 \mathbf{G}^{1/2} \bar{\mathbf{U}}_1^H (\mathbf{I} + \mathbf{P}_1 \bar{\boldsymbol{\Sigma}}_1)^{-1/2}. \quad (17)$$

According to the processing units given in (13) and (16), the MIMO relay channel is converted into several parallel SISO relay channels, and the equivalent sub-channel gain are $\sqrt{\bar{\xi}_i}$, $\sqrt{\bar{\alpha}_i}$ and $\sqrt{\bar{\beta}_i}$, respectively. Assuming the antenna configuration of the BS, relay and user are $\{n_t, n_r, m\}$, the number of the data stream can be supported simultaneously is $n = \min\{(n_t - n_r), (n_t - m), m\}$. We use the format $n \times \{\bar{\xi}, \bar{\alpha}, \bar{\beta}\}$ to illustrate this equivalent relay channel model, which is shown in Fig. 2.

Using the processing matrices given in (13) and (17), the post-processing SNR of the i th sub-channel, after MRC combining at the destination in the second time slot can be written as

$$\gamma_i = \bar{\xi}_i p_{0,i} + \frac{p_{1,i} \bar{\alpha}_i p_{2,i} \bar{\beta}_i}{1 + p_{1,i} \bar{\alpha}_i + p_{2,i} \bar{\beta}_i} \quad (18)$$

where $p_{0,i}$ and $p_{1,i}$ is given in (14). Thus, to achieve the maximal mutual information can be formulated as the following optimization problem

$$\max_{\mathbf{g}} \sum_{i=1}^n C \left(\bar{\xi}_i p_{0,i} + \frac{p_{1,i} \bar{\alpha}_i p_{2,i} \bar{\beta}_i}{1 + p_{1,i} \bar{\alpha}_i + p_{2,i} \bar{\beta}_i} \right) \quad (19)$$

such that $\sum_{i=1}^n g_i \leq P_R, g_i \geq 0$.

Since $p_{0,i}$ and $p_{1,i}$ is pre-determined, we have the Lagrangian $L(g_i, \omega)$ as

$$L(g_i, \omega) = \sum_{i=1}^n C \left(\frac{p_{1,i} \bar{\alpha}_i p_{2,i} \bar{\beta}_i}{1 + p_{1,i} \bar{\alpha}_i + p_{2,i} \bar{\beta}_i} \right) - \sum_{i=1}^n \omega g_i. \quad (20)$$

Simply using the Karush-Kuhn-Tucker (KKT) conditions, the unified optimal relay power allocation is

$$g_i = \left(\sqrt{\left(\frac{p_{1,i} \bar{\alpha}_i}{2\bar{\beta}_i} \right)^2 + \omega \frac{p_{1,i} \bar{\alpha}_i}{\bar{\beta}_i}} - \frac{p_{1,i} \bar{\alpha}_i}{2\bar{\beta}_i} - \frac{1}{\bar{\beta}_i} \right)^+ \quad (21)$$

where ω is a constant scale to satisfy the power constraint P_R .

Up to now, we have assumed that the signal is transmitted over the ordered sub-channel, i.e., the source transmits the signal on the i th ordered eigenvalue of $\bar{\mathbf{H}}_0$ and $\bar{\mathbf{H}}_1$, the relay retransmits the signal on the i th ordered eigenvalue of \mathbf{H}_2 . In the following, we will prove this paired structure can achieve high performance in terms of mutual information.

Proposition 1: High mutual information can be achieved if the sub-channels are ordered paired according to its magnitude.

Proof: According to (10), the mutual information of the relay link and the broadcast part of the BS can be written as

$$I_R = \sum_{i=1}^n \log \left((1 + \gamma_{1,i} \bar{\alpha}_i) \left(\frac{1 + \gamma_i \bar{\beta}_i}{1 + \gamma_{1,i} \bar{\alpha}_i + \gamma_i \bar{\beta}_i} \right) \right)$$

$$I_{BC} = \sum_{i=1}^n \log \left((1 + \gamma_{1,i} \bar{\alpha}_i) (1 + \gamma_{0,i} \bar{\xi}_i) \right). \quad (22)$$

□

According to [17], given two $N \times N$ positive semi-definite Hermitian matrices \mathbf{A} and \mathbf{B} with eigenvalues $\lambda_k(\mathbf{A})$ and $\lambda_k(\mathbf{B})$ arranged in the descending order, respectively, we have the following matrix inequalities

$$\sum_{k=1}^N \lambda_k(\mathbf{A}) \lambda_{N+1-k}(\mathbf{B}) \leq \text{Tr}(\mathbf{AB}) \leq \sum_{k=1}^N \lambda_k(\mathbf{A}) \lambda_k(\mathbf{B}). \quad (23)$$

Denoting $(1 + p_{1,i} \bar{\alpha}_i)$, $(1 + p_{0,i} \bar{\xi}_i)$, and $(1 + p_i \bar{\beta}_i) / (1 + p_{1,i} \bar{\alpha}_i + p_i \bar{\beta}_i)$ as the elements of diagonal matrices \mathbf{A} , \mathbf{B} , and \mathbf{C} , we have

$$I_R = \log (\text{Tr}(\mathbf{AC})) \leq \log \left(\sum_{k=1}^n \lambda_k(\mathbf{A}) \lambda_k(\mathbf{C}) \right)$$

$$I_{BC} = \log (\text{Tr}(\mathbf{AB})) \leq \log \left(\sum_{k=1}^n \lambda_k(\mathbf{A}) \lambda_k(\mathbf{B}) \right). \quad (24)$$

It shows in (24) that the mutual information has the upper bound when the sub-channels are coupled according to ordered magnitude.

IV. ACHIEVABLE SUM RATE OF BC STRATEGIES

In this section, the results derived from the single user MIMO relay channel are extended to the multiuser case. The achievable sum rates are investigated by using time sharing (TDMA), DPC, and BF strategies.

A. TDMA

In TDMA strategy, the maximum sum rate is achieved by sending to the user with the largest channel norm, and the number of data stream can be supported simultaneously is $n_{TDMA} = \min\{n_t, n_r, m\} = m$. Use the orthogonal space project method given in Section III, the MIMO relay channel can be converted into two parallel MIMO links, i.e., the direct link $\bar{\mathbf{H}}_{0,k} = \mathbf{H}_{0,k} \mathbf{V}_1^0$ and the relay link $\bar{\mathbf{H}}_1 = \mathbf{H}_1 \mathbf{V}_{0,k}^{(0)}$. According the processing structures given in (13) and (16), these two links can be paired as parallel SISO relay channels as $m \times \{\bar{\xi}_k, \bar{\alpha}_k, \beta_k\}$. Thus, the sum rate of the TDMA strategy in a multiuser MIMO relay channel is the maximal signal user capacity as

$$R_{tdma} = \max_{k \in K} \sum_{i=1}^m C \left(\bar{\xi}_i p_{0,i} + \frac{\bar{\alpha}_i \beta_{k,i} p_{1,i} p_{2,i}}{1 + \bar{\alpha}_i p_{1,i} + \beta_i + p_{2,i}} \right) \quad (25)$$

where $\bar{\xi}_{k,i}$, $\bar{\alpha}_{1,i}$, and $\beta_{k,i}$ are the i th eigenvalues of $\bar{\mathbf{H}}_{0,k}$, $\bar{\mathbf{H}}_{1,k}$, and $\mathbf{H}_{2,k}$.

The sum rate of TDMA strategy low bounds by pouring equal transmit power on the unordered eigenvalues of the direct link and relay link as

$$R_{tdma}^{LB} = mC \left(\frac{\bar{\xi}_{k,1} P_S}{2m} + \frac{\bar{\alpha}_1 \beta_{k,1} P_S P_R}{2m + m\bar{\alpha}_1 P_S + 2m\beta_{k,1} P_R} \right) \quad (26)$$

where $\bar{\xi}_{k,1}$, $\bar{\alpha}_1$, and $\beta_{k,1}$ are the 1st unordered eigenvalues of $m \times (n_t - n_r)$, $n_r \times (n_t - m)$, and $m \times n_r$ matrices with $CN(0, 1)$ elements.

B. Dirty Paper Coding

The zero-forcing dirty paper coding is used as the transceiver solution for the multiuser MIMO relay channel. Since the ZF-DPC treats multi-antenna receivers as multiple single antenna receivers, the number of data streams can be supported simultaneously is $n_{dpc} = \min\{(n_t - n_r), n_r\}$. Let S denotes the all possible receive antenna sets; a user subset A is selected to be served together, where $|A| \leq n_{dpc}$. The corresponding channel matrices are $\mathbf{H}_0(A)$, \mathbf{H}_1 , and $\mathbf{H}_2(A)$, respectively. Using the orthogonal projecting method, the MIMO relay channel can be converted into two parallel MIMO channels as $\bar{\mathbf{H}}_0(A) = \mathbf{H}_0(A) \mathbf{V}_1^{(0)}$ and $\bar{\mathbf{H}}_1 = \mathbf{H}_1 \mathbf{V}_{0,A}^{(0)}$. Applying QR decomposition as $\bar{\mathbf{H}}_0(A) = \bar{\mathbf{R}}_{0,A} \bar{\mathbf{Q}}_{0,A}$ and SVD of $\bar{\mathbf{H}}_1$, the processing matrix of the BS can be written as

$$\mathbf{F}_{dpc} = [\mathbf{V}_{0,A}^{(0)} \quad \mathbf{V}_1^{(0)}] \text{diag}\{ \bar{\mathbf{V}}_1, \mathbf{Q}_{0,A}^H \} \text{diag}\{ \mathbf{P}_1^{1/2}, \mathbf{P}_{0,A}^{1/2} \} \quad (27)$$

where \mathbf{P}_1 and $\mathbf{P}_{0,A}$ are are weighted by waterfilling on the eigenvalues $\{\bar{\alpha}_1, \dots, \bar{\alpha}_{n_{dpc}}\}$ and the diagonal elements $|(\bar{\mathbf{R}}_{0,A})_{i,i}|^2$. The corresponding relay processing matrix is

$$\mathbf{W}_{dpc} = \mathbf{Q}_{2,A}^H \mathbf{G}^{1/2} \bar{\mathbf{U}}_1^H (\mathbf{I} + \mathbf{P}_1^{1/2} (\bar{\mathbf{R}}_{0,A})_{i,i})^{-1/2} \quad (28)$$

where $\mathbf{Q}_{2,A}$ is obtained by QR decomposition of $\mathbf{H}_2(A)$.

Use these two processing matrices, and the ZF-DPC scheme, the multiuser MIMO relay channel can be converted into parallel

SISO relay channels with the format as $n_{dpc} \times \{(\bar{\tau}, \varphi), \bar{\alpha}, (\rho, \delta)\}$ where

$$\begin{aligned} \bar{\tau}_i &= |(\bar{\mathbf{R}}_{0,A})_{i,i}|^2, \quad \varphi_i = \sum_{j=1}^i |(\bar{\mathbf{R}}_{0,A})_{i,j}|^2 \\ \rho_i &= |(\mathbf{R}_{2,A})_{i,i}|^2, \quad \delta_i = \sum_{j=1}^i |(\mathbf{R}_{2,A})_{i,j}|^2. \end{aligned} \quad (29)$$

With the power allocation scheme given in (14) and (21), we have the optimal power allocation as

$$p_{1,i} = \left(\mu - \frac{1}{\bar{\alpha}_i} \right)^+, \quad p_{0,i} = \left(\mu - \frac{\varphi_i}{\bar{\tau}_i} \right)^+, \quad (30)$$

and

$$g_i = \left(\sqrt{\left(\frac{p_{1,i} \bar{\alpha}_i}{2\rho_i} \right)^2 + \omega \frac{p_{1,i} \bar{\alpha}_i}{\rho_i}} - \frac{p_{1,i} \bar{\alpha}_i}{2\rho_i} - \frac{\delta_i}{\rho_i} \right)^+. \quad (31)$$

Then, the sum rate of MIMO relay channel with ZF-DPC strategy can be concluded as finding the optimal receive antenna subset A as

$$R_{dpc} = \max_{A \in S} \sum_{i=1}^{n_{dpc}} C \left(\frac{\bar{\tau}_{A,i} p_{0,i}}{\varphi_{A,i}} + \frac{\bar{\alpha}_i \rho_{A,i} p_{1,i} p_{2,i}}{1 + \bar{\alpha}_i p_{1,i} + \delta_{A,i} p_{2,i}} \right). \quad (32)$$

For the DPC strategy, it is well known that the sum rate is upper bounded when the users are allowed to cooperative receive, i.e., if the subset A is the maximal sum rate achievable receiver subgroup, the upper bound can be expressed as

$$R_{dpc}^{UB} \leq n_{dpc} C \left(\frac{\bar{\xi}_{A,\max} P_S}{2n_{dpc}} + \frac{\bar{\alpha}_{\max} \beta_{A,\max} P_S P_R}{2n_{dpc}^2 + n_{dpc} \bar{\alpha}_{\max} P_S + 2n_{dpc} \beta_{A,\max} P_R} \right) \quad (33)$$

C. Beamforming

The BD method [16] is used as the transceiver solution for the linear beamforming method of the MIMO relay networks. Let S denote the all possible user sets, we select a user subset B to be served together. The size of S , i.e., the number of user can be supported simultaneously by the beamforming scheme is $n_{bf} = \min\{(n_t - n_r), n_r\}/m$.

Let $\mathbf{H}_0(B) = [\mathbf{H}_{0,B,1}^T, \dots, \mathbf{H}_{0,B,n_{bf}}^T]^T$ and \mathbf{H}_1 denote the downlink channels of the BS-receivers links and BS-relay link, $\mathbf{H}_2(B) = [\mathbf{H}_{2,B,1}^T, \dots, \mathbf{H}_{2,B,n_{bf}}^T]^T$ denotes the relay to receivers' links, respectively. Applying the orthogonal projecting method and the BD algorithm to the BS downlink channel $\mathbf{H}_{dl} = [\mathbf{H}_1^T, \mathbf{H}_0(B)^T]^T$, the processing matrix of the BS can be written as

$$\begin{aligned} \mathbf{F} &= [\tilde{\mathbf{V}}_{0,B}^{(0)} \quad \tilde{\mathbf{V}}_1^{(0)}] \text{diag}\{ \bar{\mathbf{V}}_1, \bar{\mathbf{V}}_{0,B,1}, \dots, \bar{\mathbf{V}}_{0,B,n_{dpc}} \} \\ &\quad \times \text{diag}\{ \mathbf{P}_1^{1/2}, \mathbf{P}_{0,B,1}^{1/2}, \dots, \mathbf{P}_{0,B,n_{dpc}}^{1/2} \} \end{aligned} \quad (34)$$

and the processing matrix of the relay is

$$\mathbf{W}_{bf}^{dl} = \mathbf{T}_D \mathbf{G}^{1/2} \bar{\mathbf{U}}_1^H (\mathbf{I} + \mathbf{P}_1^{1/2} \bar{\Sigma}_1)^{-1/2} \quad (35)$$

where $\mathbf{T}_{\mathcal{D}} = [\tilde{\mathbf{V}}_{2,1}^{(0)} \cdots \tilde{\mathbf{V}}_{2,n}^{(0)}] \text{diag}\{\bar{\mathbf{V}}_{2,1}, \dots, \bar{\mathbf{V}}_{2,n}\}$ is the BD BF of $\mathbf{H}_2(B)$. Then, the multiuser MIMO relay channel into n_{dpc} can be converted into single MIMO user relay channels, each of them is constituted by m single SISO relay channels, i.e., $m \times n_{bf} \times \{\zeta_B, \bar{\alpha}, \bar{\beta}_B\}$. $\bar{\alpha}$, ζ_B , and $\bar{\beta}_B$ are the eigenvalues of equivalent channels after block diagonalization of H_{dl} and $\mathbf{H}_2(B)$. Weighting the transmit power by waterfilling algorithm, the sum rate of the beamforming strategy can be formulated to find the optimal user subset B as

$$R_{bf} = \max_{B \in \mathcal{S}} \sum_{k=1}^{n_{bf}} \sum_{i=1}^m C \left(\zeta_{0,k,i} p_{0,k,i} + \frac{\bar{\alpha}_{k,i} \bar{\beta}_{k,i} p_{1,k,i} p_{2,k,i}}{1 + \bar{\alpha}_{k,i} p_{1,k,i} + \bar{\beta}_{k,i} p_{2,k,i}} \right). \quad (36)$$

The sum rate lower bound of the beamforming strategy is achieved by pouring equal power on the unordered eigenvalues of the 1st user subset B as

$$R_{bf}^{LB} \leq \ell C \left(\frac{\zeta_{B,1} P_S}{2\ell} + \frac{\bar{\alpha}_1 \bar{\beta}_{B,1} P_S P_R}{2\ell^2 + \ell \bar{\alpha}_1 P_S + 2\ell \bar{\beta}_{B,1} P_R} \right) \quad (37)$$

where $\ell = m \times n_{bf} = n_{dpc}$, $\zeta_{B,1}$, and $\bar{\beta}_{B,1}$ are the 1st unordered eigenvalue of an $m \times m$ matrix with $CN(0, 1)$ entries, $\bar{\alpha}_1$ is the 1st unordered eigenvalue of an $n_r \times n_r$ matrix with $CN(0, 1)$ elements.

D. Sum Rate Comparison

Define $G_1 = R_{dpc}/R_{tdma}$ and $G_2 = R_{dpc}/R_{bf}$ as the ratio of sum rate achieved by DPC gain over TDMA and BF, respectively. According to the sum rate bounds given in (26), (33), and (37), we have following results.

$$1 \leq G_1 \leq \frac{R_{dpc}^{UB}}{R_{tdma}^{LB}} \leq \frac{n_{dpc}}{n_{tdma}} = \frac{\min\{(n_t - n_r), n_r\}}{m} \quad (38)$$

$$1 \leq G_2 \leq \frac{R_{dpc}^{UB}}{R_{bf}^{LB}}. \quad (39)$$

The lower bound $G_1 = G_2 = 1$ is intuitive from the case that there is only one user in the network, i.e., $R_{tdma} = R_{dpc} = R_{bf}$.

Assuming the entries of channel matrices are independent and identically distribution (i.i.d.) according to $CN(0, 1)$, which corresponds to independent Rayleigh fading case, the sum rate is equal to the expected value of the sum rate in each fading state. The ergodic sum rate bound of each strategy can be expressed as

$$E(R_{tdma}^{LB}) \geq m \log \left(\frac{E(\xi_{tdma}) P_S}{2m} + \frac{P_S P_R E(\alpha_{tdma}) E(\beta_{tdma})}{2m^2 + m P_S E(\alpha_{tdma}) + 2m P_R E(\beta_{tdma})} \right) \quad (40)$$

$$E(R_{dpc}^{UB}) \leq n_{dpc} \log \left(1 + \frac{P_S E(\xi_{dpc})}{2n_{dpc}} + \frac{P_S P_R E(\alpha_{dpc}) E(\beta_{dpc})}{2n_{dpc}^2 + n_{dpc} P_S E(\alpha_{dpc}) + 2n_{dpc} P_R E(\beta_{dpc})} \right) \quad (41)$$

$$E(R_{bf}^{LB}) \geq n_{dpc} \log \left(\frac{P_S E(\xi_{bf})}{2n_{dpc}} + \frac{P_S P_R E(\alpha_{bf}) E(\beta_{bf})}{2n_{dpc}^2 + n_{dpc} P_S E(\alpha_{bf}) + 2n_{dpc} P_R E(\beta_{bf})} \right) \quad (42)$$

where ξ_{tdma} , α_{tdma} , and β_{tdma} are the 1st unordered eigenvalue of $m \times (n_t - n_r)$, $n_r \times (n_t - m)$ and $m \times n_r$ matrices with $CN(0, 1)$ elements. ξ_{dpc} , α_{dpc} , and β_{dpc} are the largest eigenvalue of $n_{dpc} \times (n_t - n_r)$, $n_r \times (n_t - n_{dpc})$, and $n_{dpc} \times n_r$ matrices with $CN(0, 1)$ elements. ξ_{bf} , α_{bf} , and β_{bf} are the 1st unordered eigenvalue of $n_{dpc} \times (n_t - n_r)$, $n_r \times (n_t - n_{dpc})$, and $n_{dpc} \times n_r$ matrices with $CN(0, 1)$ elements. The expectation of the unordered and the largest eigenvalue can be calculated use the distribution given in [5] and [18].

V. NUMERICAL RESULTS

In this section, the sum rate of the multiuser MIMO relay channel are evaluated, with different BC strategies and the sum rate comparison presented in the previous section. In the simulation, all channel matrices have independent and identically distributed $CN(0, 1)$ entries, the number of users in the system is set as $K = 50$. The optimal user subset is selected by using the capacity-based greedy searching algorithm from the all possible user sets. The format $\{n_t \times n_r \times m\}$ is used to illustrate antenna configurations of the terminals. Fig. 3 shows the achievable sum rate of different broadcast strategies derived in Section IV, as the function of $SNR_{BS-user}$, $SNR_{BS-Relay}$, and $SNR_{relay-users}$. We set $SNR_{BS-users} = SNR_{relay-users} = 10$ dB in the simulation. As expected, the ZF-DPC shows performance gain over TDMA and BF. From the slope, the BF shows the same increasing rate comparing with the ZF-DPC; and the TDMA strategy has the ‘‘ceil,’’ which can be explained by the multiuser diversity gain.

The DPC sum rate gains over the TDMA and BF strategies with the antenna configurations as $\{8 \times 4 \times 2\}$ and $\{16 \times 6 \times 2\}$ are presented in Figs. 4–7, respectively. In each case, the sum rate of the TDMA and BF strategies are normalized. The SNR of the direct link is set to 5 dB, which is a reasonable case when the direct link between the BS and users are heavy shadowing. The ‘‘mesh’’ grid is used to show the sum rate bounds comparison given in (40)–(42).

The TDMA results show that the sum rate gain upper bounds by $\min\{(n_t - n_r), n_r\}/m$ for each scenario, especially in the low SNR region, i.e., region ‘‘B’’ in Fig. 4. The sum rate gain shows slightly decrease with $SNR_{BS-Relay}$ increasing, i.e., region ‘‘A’’; and remarkable decrease with $SNR_{relay-users}$ increasing, i.e., region ‘‘C.’’ We explain this by comparing with

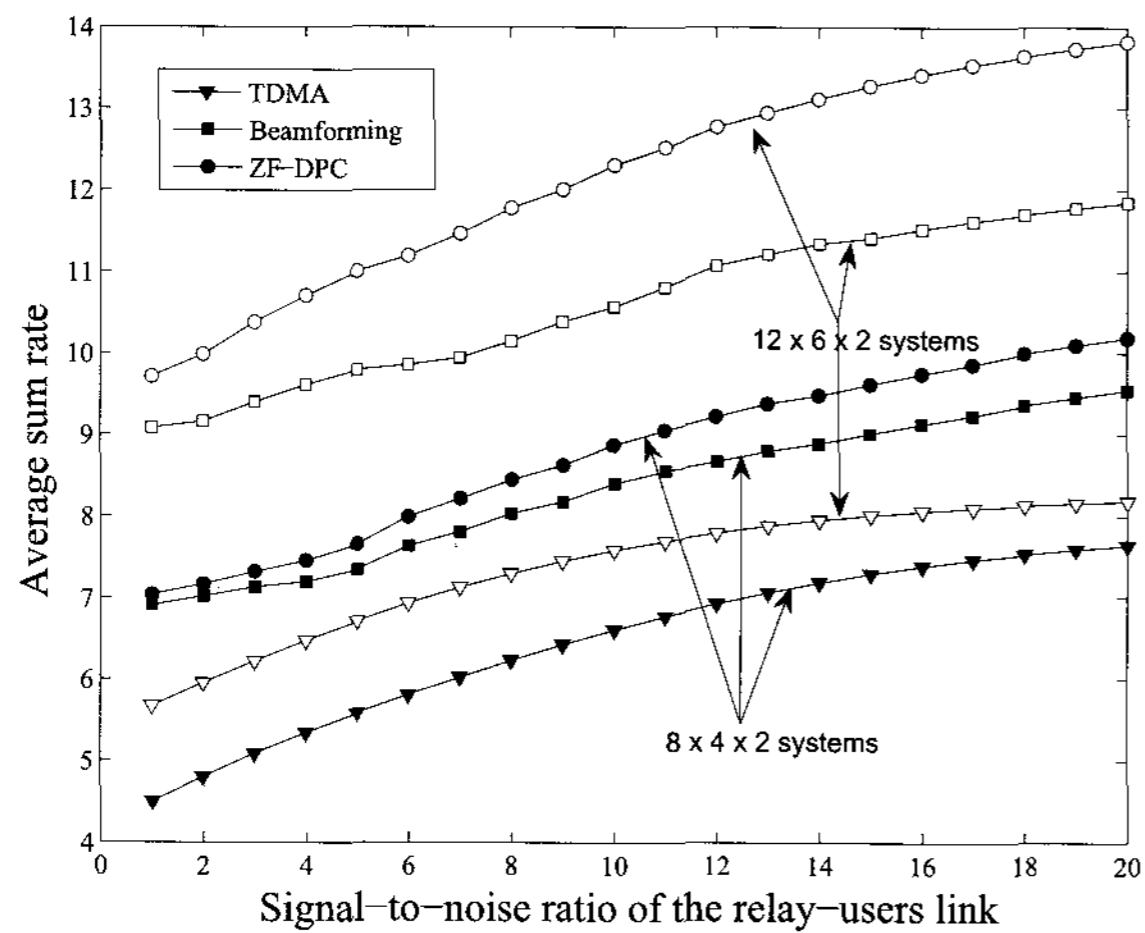
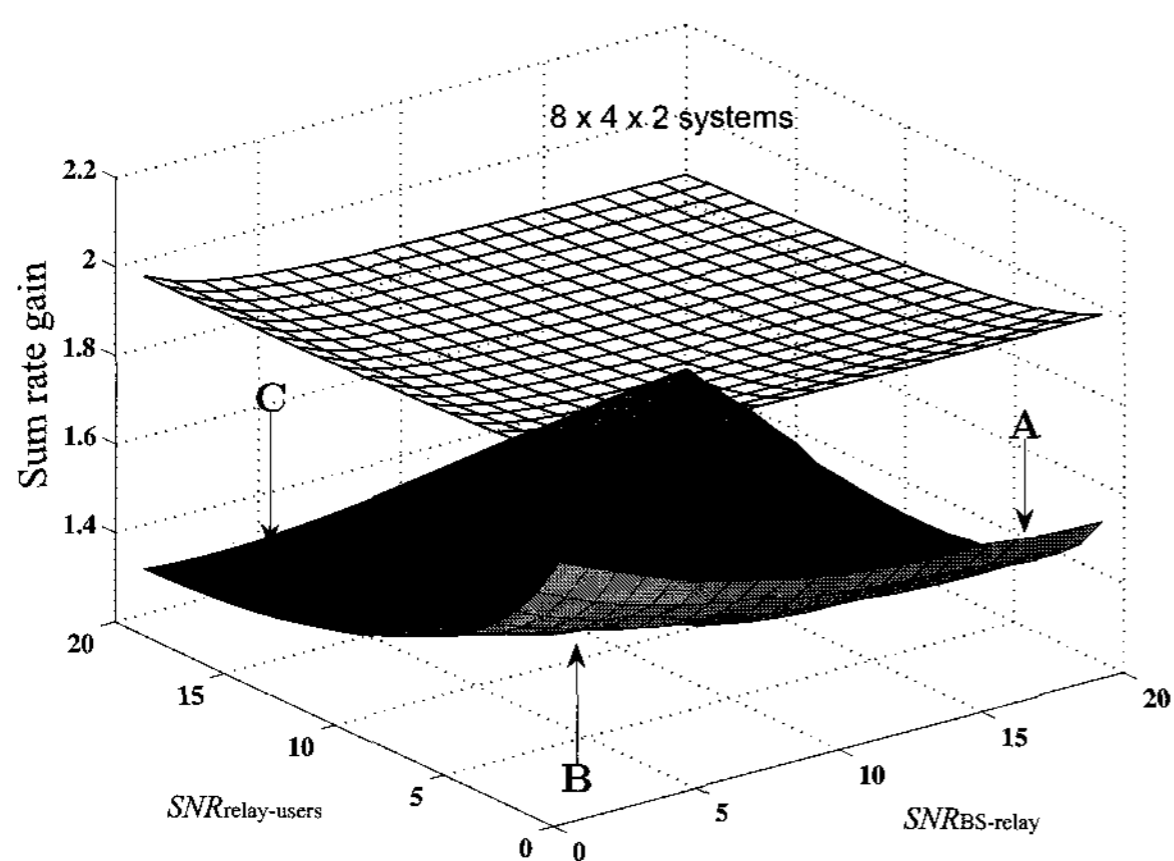
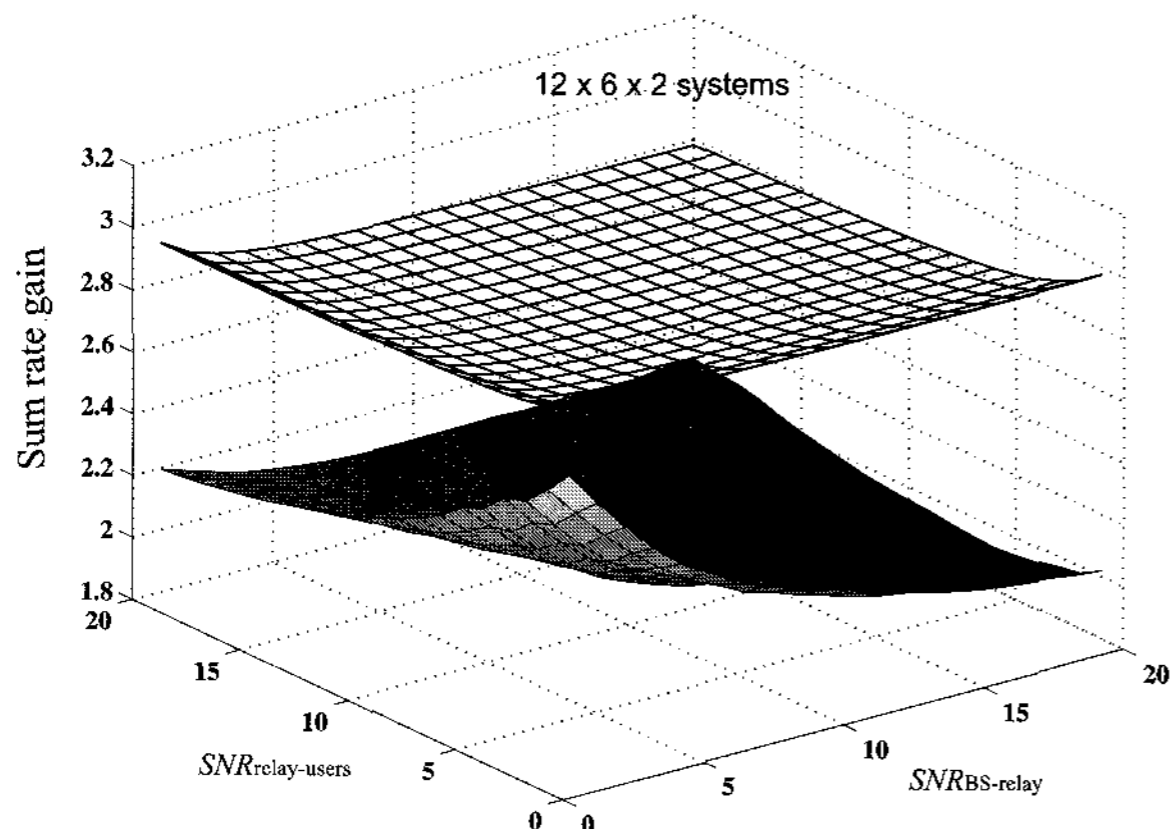

Fig. 3. Average sum rate for different BC strategies.

Fig. 4. Sum rate gain over TDMA strategy in $\{8 \times 4 \times 2\}$ case.Fig. 5. Sum rate gain over TDMA strategy in $\{12 \times 6 \times 2\}$ case.

the MIMO systems. In the region "C," $SNR_{\text{relay-users}} \gg SNR_{\text{BS-Relay}}$, all the information from the BS to relay can be re-transmitted to users, thus the MIMO relay channel can be viewed as a single user MIMO channel between the BS and relay (omit the direct link and the delay of two time slots transmission). Since $SNR_{\text{BS-Relay}}$ is low, the number of effective sub-channel is limited. In the region B, both SNR of each link is low, the spatial multiplexing gain is dominated for the sum rate

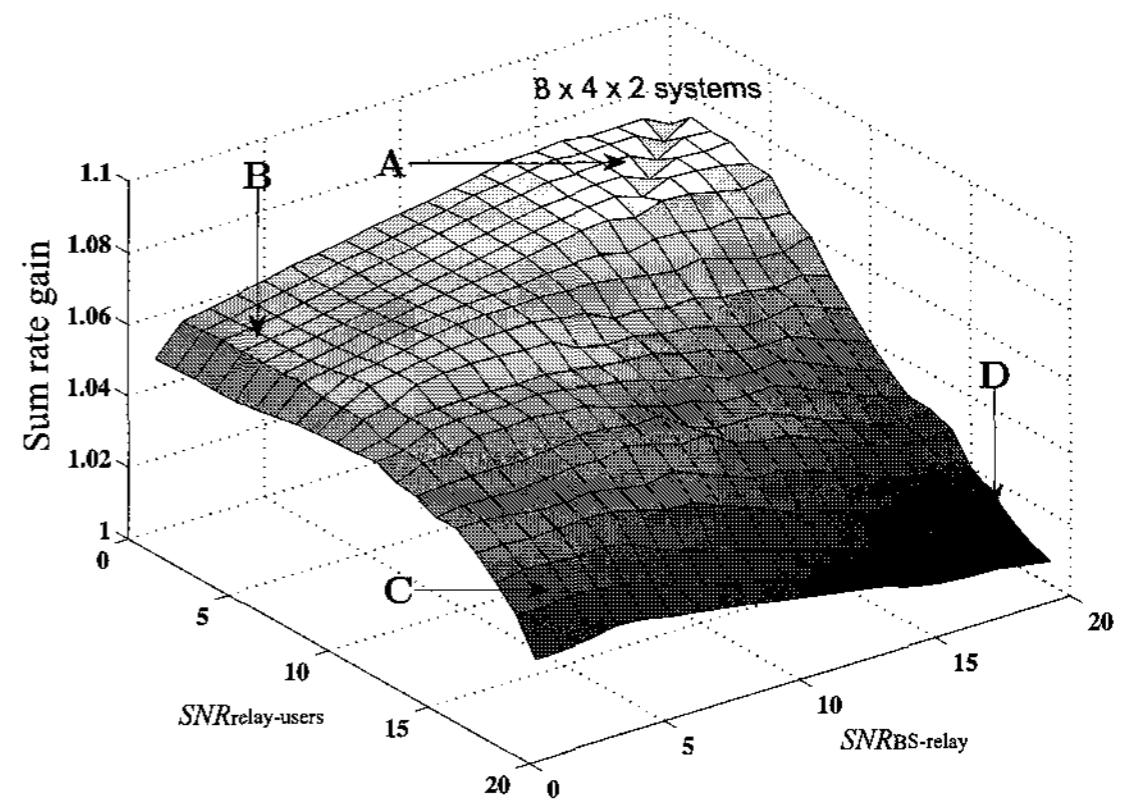

Fig. 6. Sum rate gain over BF strategy in case.

Fig. 7. Sum rate gain over BF strategy in $\{12 \times 6 \times 2\}$ case.

Fig. 8. Explanation by comparing with the MIMO system.

gain. As in the region A, $SNR_{\text{BS-Relay}} \gg SNR_{\text{relay-users}}$, all the information of the BS can be transmitted to the relay, and the MIMO relay channel can be viewed as a multiuser MIMO channel. Thus, the spatial multiplexing gain is dominated for the sum rate comparison, which is slightly increased with $SNR_{\text{relay-users}}$ as shown in the region "D" (omitted in Fig. 4, see it in Fig. 6).

As expected, the beamforming results show that the sum rate gain lower bounds by 1 for each scenario. This can also be explained by comparing with the MIMO systems. In the region

“C,” the MIMO relay channel can be viewed as a single MIMO channel. Thus, the sum rate gain is almost 1. In the region A, the MIMO relay channel can be viewed as a multiuser MIMO channel. The sum rate of the BF is limited by the low SNR of the relay-users links, and the sum rate gain is maximized. With the SNR increasing of the relay-users links, the sum rate gain is decreased. This can be explained that the performance of the BF strategy is comparable with the ZF-DPC strategy in the high SNR region, i.e., the region “D.” The comparison with the MIMO systems is shown in Fig. 8.

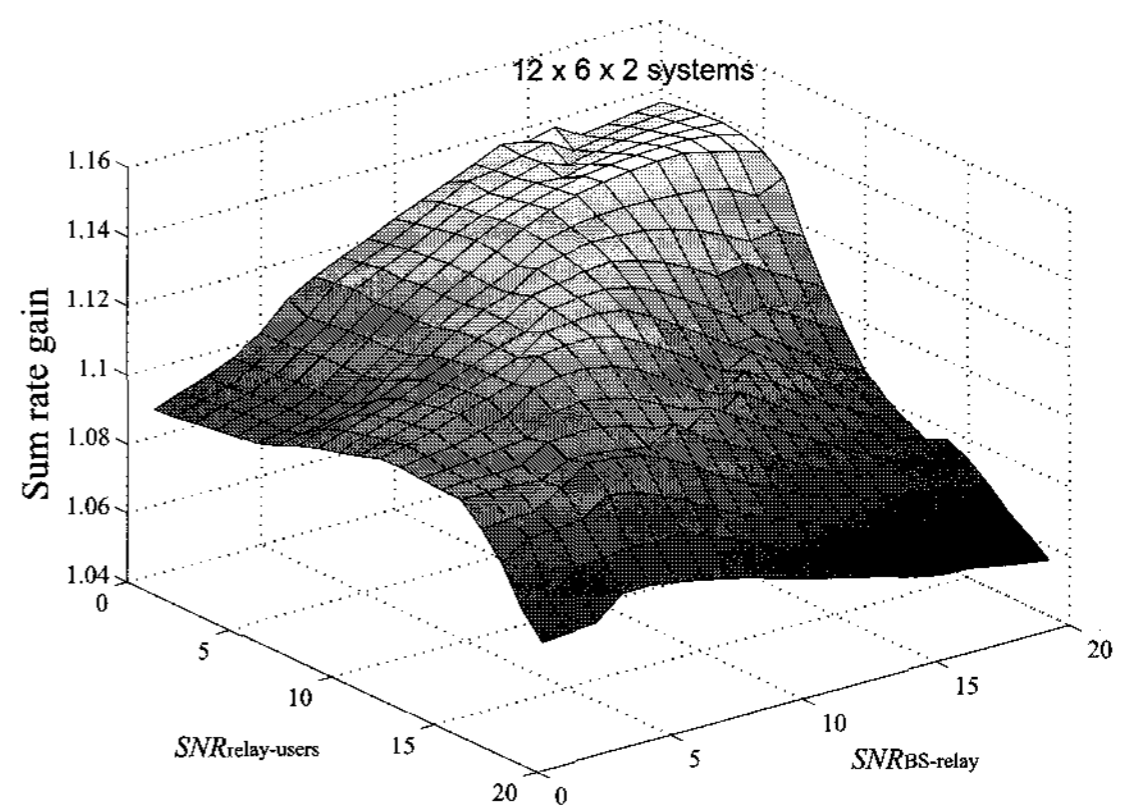
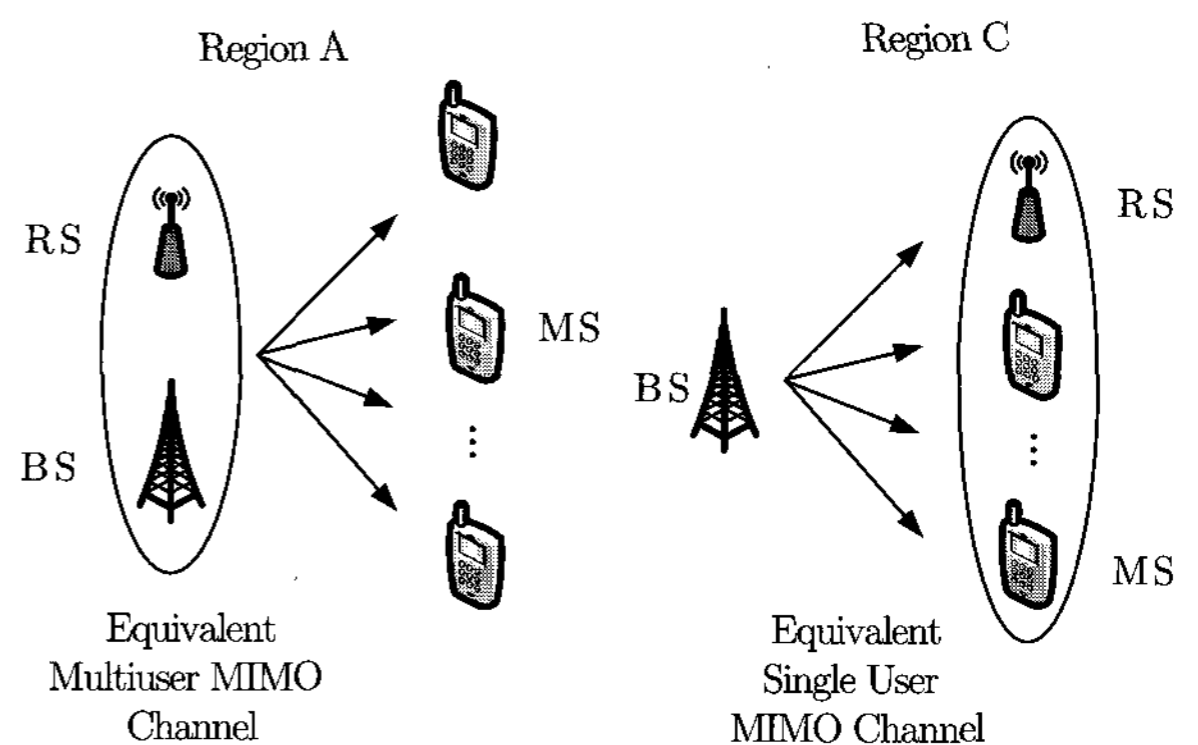
VI. CONCLUSIONS

In this paper, the sum rate issue of the multiuser MIMO relay network is considered. The optimal processing structures at the BS and relay are given, from the sum rate point-of-view. Three broadcasting strategies, i.e., TDMA, ZF-DPC, and BF are investigated and compared. Denoting the number of antennas at the BS, relay and users are n_t , n_r and m , respectively, we found that the sum rate gain of the DPC over TDMA is upper bounded by $\min\{(n_t - n_r), n_r\}/m$, and it is near 1 for the BF strategy. These results can be explained by comparing the multiuser MIMO relay channel with the tradition MIMO BC.

VII. ACKNOWLEDGEMENT

The authors would thank for the anonymous reviewers for their valuable comments.

REFERENCES

- [1] R. Pabst, B. H. Walke, D. C. Schultz, D. C. Herhold, H. Yanikomeroglu, S. Mukherjee, H. Viswanathan, M. Lott, W. Zirwas, M. Dohler, H. Aghvami, D. D. Falconer, and G. P. Fettweis, “Relay-based deployment concepts for wireless and mobile broadband radio,” *IEEE Commun. Mag.*, vol. 42, no. 9, pp. 80–89, Sept. 2004.
- [2] J. N. Laneman, D. N. C. Tse, and G. W. Wornell, “Cooperative diversity in wireless networks: Efficient protocols and outage behavior,” *IEEE Trans. Inf. Theory* vol. 50, no. 12, Dec. 2004.
- [3] R. U. Nabar, H. Bolcskei, and F. W. Kneubuhler, “Fading relay channels: Performance limits and space-time signal design,” *IEEE J. Sel. Areas Commun.*, vol. 22, no. 6, pp. 1099–1109, Aug. 2004.
- [4] A. Sendonaris, E. Erkip, and B. Aazhang, “User cooperation diversity: Part I. system description,” *IEEE Trans. Commun.*, vol. 51, no. 11, pp. 1927–1938, Nov. 2003.
- [5] E. Telatar, “Capacity of multi-antenna Gaussian channel,” *European Trans. Telecommun.*, vol. 10, no. 6, pp. 585–595, Nov. 1999.
- [6] Bo Wang, J. Zhang, and A. Host-Madsen, “On the capacity of MIMO relay channels,” *IEEE Trans. Inf. Theory*, vol. 51, no. 1, pp. 29–43, Jan. 2006.
- [7] X. Tang and Y. Hua, “Optimal design of non-regenerative MIMO wireless relays,” *IEEE Trans. Wireless Commun.*, vol. 6, no. 4, pp. 1398–1407, Apr. 2007.
- [8] O. M. Medina, J. Vidal, and A. Agustin, “Linear transceiver design in non-regenerative relays with channel state information,” *IEEE Trans. Signal Process.*, vol. 55, no. 5, pp. 2593–2604, June 2007.
- [9] G. Caire and S. Shamai, “On the achievable throughput of a multi-antenna gaussian broadcast channel,” *IEEE Trans. Inf. Theory*, vol. 49, no. 7, pp. 1691–1706, July 2003.
- [10] Costa, M. “Writing on dirty paper,” *IEEE Trans. Inf. Theory*, vol. 29, pp. 439–441, 1983.
- [11] S. Vishwanath, N. Jindal, and A. Goldsmith, “Duality, achievable rates, and sum-rate capacity of MIMO broadcast channels,” *IEEE Trans. Inf. Theory*, vol. 49, no. 10, pp. 2658–2668, Oct. 2003.
- [12] P. Viswanath and D. Tse, “Sum capacity of the vector Gaussian broadcast channel and uplink/downlink duality,” *IEEE Trans. Inf. Theory*, vol. 49, no. 8, pp. 1912–1921, Aug. 2003.

- [13] N. Jindal and A. Goldsmith, “Dirty-paper coding vs. TDMA for MIMO broadcast channels,” *IEEE Trans. Inf. Theory*, vol. 51, no. 5, pp. 1783–1794, May 2005.
- [14] S. Boyd and L. Vandenberghe, *Convex Optimization*. Cambridge University Press, 2004.
- [15] C. B. Chae, T. Tang, R. W. Heath, Jr., and S. Cho, “MIMO relaying with linear processing for multiuser transmission in fixed relay networks,” *IEEE Trans. Signal Process.*, vol. 56, no. 2, pp. 727–738, Feb., 2008.
- [16] Q. H. Spencer, A. L. Swindlehurst, and M. Haardt, “Zero-forcing methods for downlink spatial multiplexing in multiuser MIMO channels,” *IEEE Trans. Signal Process.*, vol. 52, no. 2, pp. 461–471, Feb. 2004.
- [17] R. A. Horn and C. R. Johnson, *Matrix Analysis*. Cambridge University Press, 1985.
- [18] P. A. Dighe, R. K. Mallik, S. S. Jamuar, “Analysis of transmit-receive diversity in Rayleigh fading,” *IEEE Trans. Commun.*, vol. 51, no. 4, pp. 694–703, Apr. 2004.

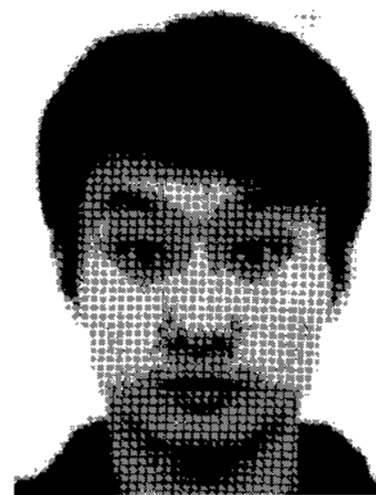

Jianing Li received the B.Sc. and M.S. degrees both in communication engineering from Information Engineering University, China, in 2002 and 2005, respectively. He is a Ph.D. student in Wireless Technology Innovation (WTI) Institute of Beijing University of Posts and Telecommunications. His research interests include the transmission techniques of IMT-Advanced systems, cooperative transmission technology.



Jianhua Zhang currently is an associate professor of Beijing University of Posts and Telecommunications (BUPT), Beijing, China. She received the M.S. and Ph.D. degrees from BUPT in 2000 and 2003, respectively, both in circuits and systems. From Feb. 2002 to Oct. 2002, she studied in Technical University of Hamburg-Harburg University (TUHH) as an exchanged Ph.D. student. Her research interests include transmission techniques of IMT-Advanced systems, broadband MIMO channel measurements and modelling, and cooperative transmission technique. In 2005, she was awarded as Beijing Star of Science and Technology.



Yu Zhang received the B.Sc. degree in electrical engineering from Beijing University of Aeronautics and Astronautics, China, in 2003, and the M.S. degree in circuits and systems from Beijing Jiaotong University, China, in 2006. He is currently working towards the Ph.D. degree at Beijing University of Posts and Telecommunications. His current research interests include radio propagation, wideband MIMO channel measurements, and channel modeling and simulation in cooperative networks.

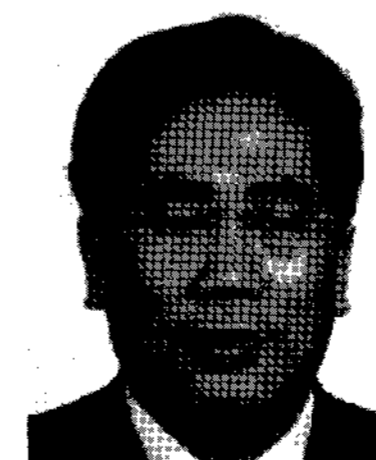

Ping Zhang received an M.S. degree from Northwestern Polytechnic University, Xian, China, in 1986 and a Ph.D. degree from Beijing University of Posts and Telecommunications (BUPT), China, in 1990, both in electronics engineering. He is now a professor at BUPT, director of the Wireless Technology Innovation Laboratories, and a member of the China 3G and B3G groups, and the WWRP vision committee. His research interests cover the key techniques of B3G and 3G systems, especially multiple access techniques, modulation, and channel coding.