

Development of Pocket Insertion style Magnetic Curer that Apply 2^{loop} 3^{pulsed} Variable Magnetic type Probe for Urinary Treatment

Whi-Young Kim, *Member, KIMICS*

Abstract— Result that study magnet nerve curer for treatment induced current generation and current of ion for development in main point incontinence, prostate, sphincter, nervous system, rigidity, headache, retrogression arthritis, ligament damage, Rheumatism arthritis, peripheral nerve etc., can classify by 4. Embodied do first, full bridge magnet occurrence chapter, and communication with PC is available, confirmed various action loops an experiment. Could confirm correct treatment probe second, woman and man disease person. Third, derived so that healing may be possible naturally by addition of apron form according to disease. Because composition of finally, treatment probe composes by act of negative plate form, manufacture is easy and cooling designed for easy direction. More superior result of cooling appeared than existing in incidental and ingredients, cooling efficiency, composition, complexity, convenience etc. that expense and composition manufacture very straightforwardly and experimental by 2 - Tank ways.

Index Terms—magnetic, stimulator, urinary, 2^{loop} 3^{pulsed}.

I. INTRODUCTION

Urinary incontinence in urine adjustment incapability phenomenon various kinds realize. Functional main point incontinence is cerebrum muddiness, course flowing main point fine crack important position of that is blocked, is happened by destructure traction failure when bladder packs and stress main point incontinence is happened by spirit. That is, conscious control of bladder and urethra sphincter is impossible. New solidity bladder depression is that is happened by brain and war of hand, bladder neoplasm or absence, multiple sclerosis, lower part ureteric blockade, senility, cause of fecundity and so on during various kinds cause. Child's Urinary incontinence silver spiritual overcharge cause or allergy is cause. There is drug-stuffs treatment according to cause, mind overcharge treatment, surgical operation etc., speak perpendicular and horizontal fiber kun that form outside class of bladder urination muscle, bladder at destructure urinary muscle. Existent electricity stimulation flag can touch, and have sore directly in body

in research, but application extent of magnetic stimulation is widened extensively by muscle disease system etc.. in various nerve diseases without contact and without invasion. If explain body effect to basic principle gouging magnetic, body put among ago receives power failure judo and range charge for all direction on the body surface. Because hair receives force in, laudable custom is correct impression in about 200 kV/more than ms usually. If discharge happens in pointed end department of living body in hard fighting of 2,000 kV/more than ms, red heat stuff or skin if is surface of the body that feel mordant prompt by hands of a clock to relationship peripheral nerve and so on influence can .

Usually, magnetic-field's strength 0.1 ~ 1T (tesla) * 6 that exert action in living body if is imposed do. Recently, in strong magnetic field to 2T degree that use 0.04 ~ 0.2T, super entire island electromagnet that use permanent magnet or electromagnet in imaging device that use NMR (nuclear magnetic resonance) phenomenon that is used in presence at a sickbed for diagnosis patient because is done effect to human body of magnetic field festinate observe. For example, existence and nonexistence etc.. of interference action can become an issue mutually with electric wave, radiation, supersonic waves etc. That become most to problem in low frequency magnetic field is that is based in common use interchange.

Magnetic field that pocket style magnetic stimulator changes by time on human body interior electric field there is no contact because done induction and come at recent times to peripheral nervous system, encephalopathy, cranial nerves, strength, urinary albumin, senescent, muscular disease, rehabilitation treatment etc.. by advantage that stimulation of deep and, wide region is possible without invasion and research is progressing abuzz vigorously. Specially, studied own nerve curer for treatment induction current generation and current of ion for development to urinary albumin, prostate, sphincter, peripheral nervous system, cervical inflammation, headache, retrogression arthritis, ligament damage, Rheumatism arthritis, cranial nerves etc. Composed magnetic stimulator by pocket style that PC and communication are available, and confirmed various action loops an experiment. Second, Could confirm correct treatment probe woman and man patient. Third, derived so that healing may be possible naturally by addition of apron form according to disease. Fourth, because treatment probe's composition composes by act of negative plate form, manufacture is easy and cooling designed for easy direction. Expense and composition of

Whi-Young Kim is with the Department of Biomedical Engineering , Dongju College, Busan, 604-715, Korea (Tel: +82-051-200-3449, Fax: +82-051-200-3449, Email: ndyag@dongju.ac.kr)

cooling wish to manufacture very straightforwardly and illuminate systematically in incidental and ingredients, cooling efficiency, composition, complexity, convenience etc

II. SYSTEMS EMBODIMENT

2.1 power supply design

As see in figure 1, if explain whole function. First, compose by feedback circuit and so on for circuit that do current moving current compensation function, circuit including Battery tank department to do charge, PC link department for data processing, system stable control.

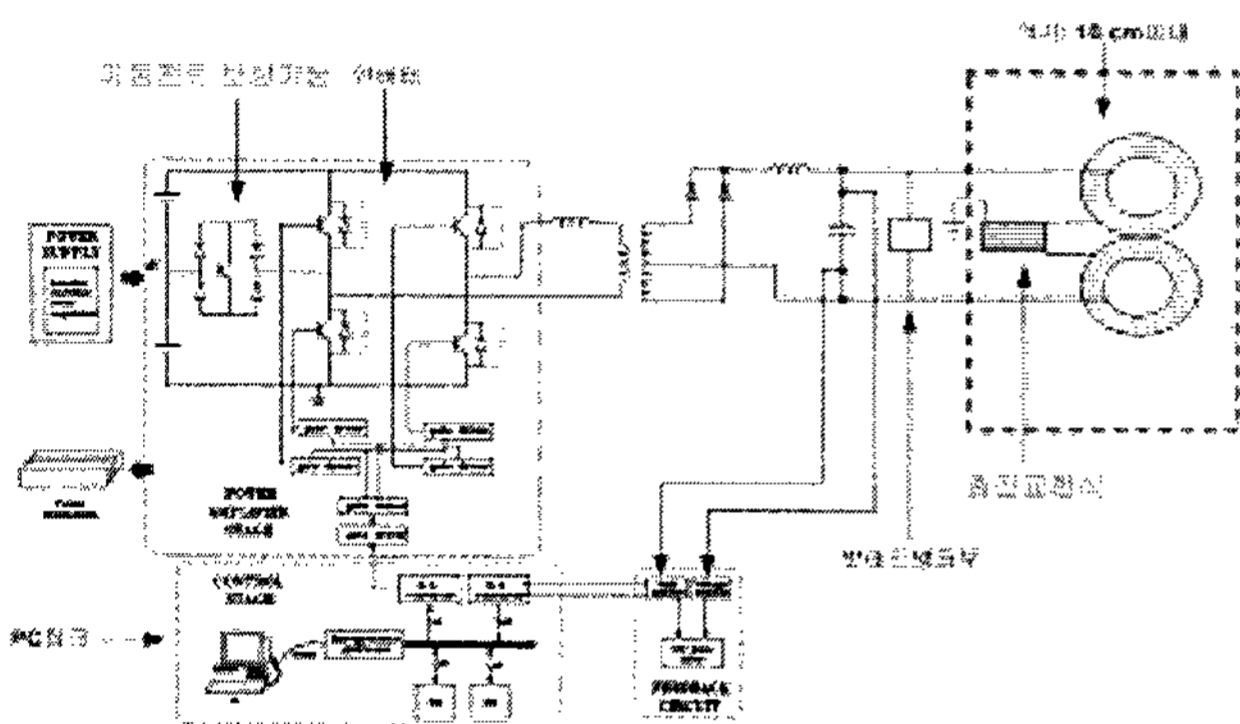

Figure .1 2^{loop} 3^{pulsed} Concept of pocket insertion style magnetic nerve system diagram

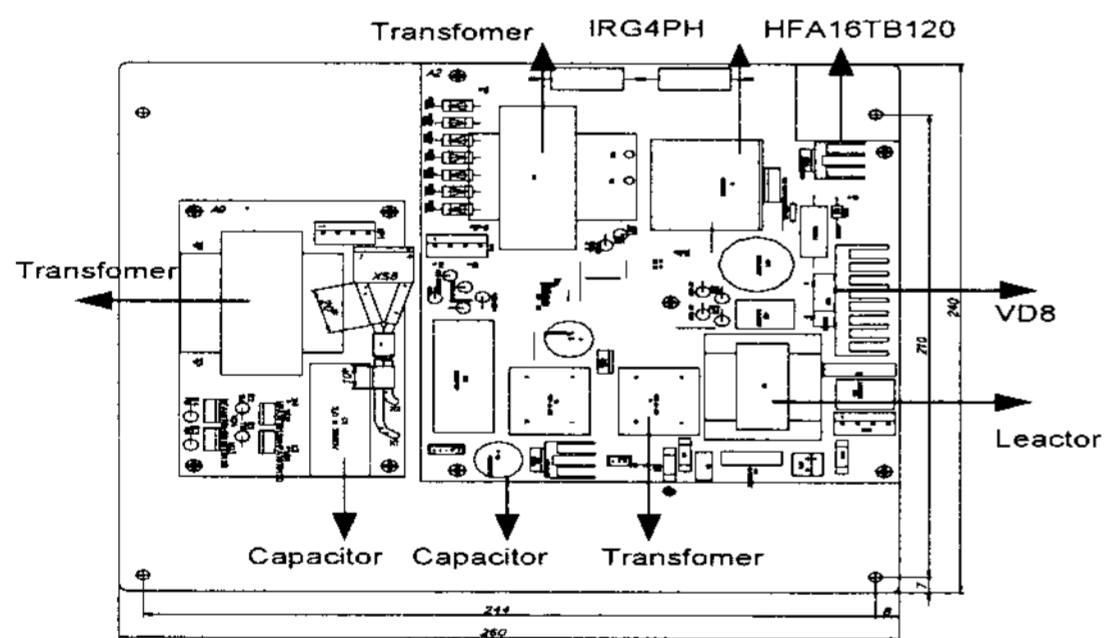

Figure .2. 2^{loop} 3^{pulsed} Power supply of pocket insertion style magnetic nerve system that apply variableness magnetic tent probe

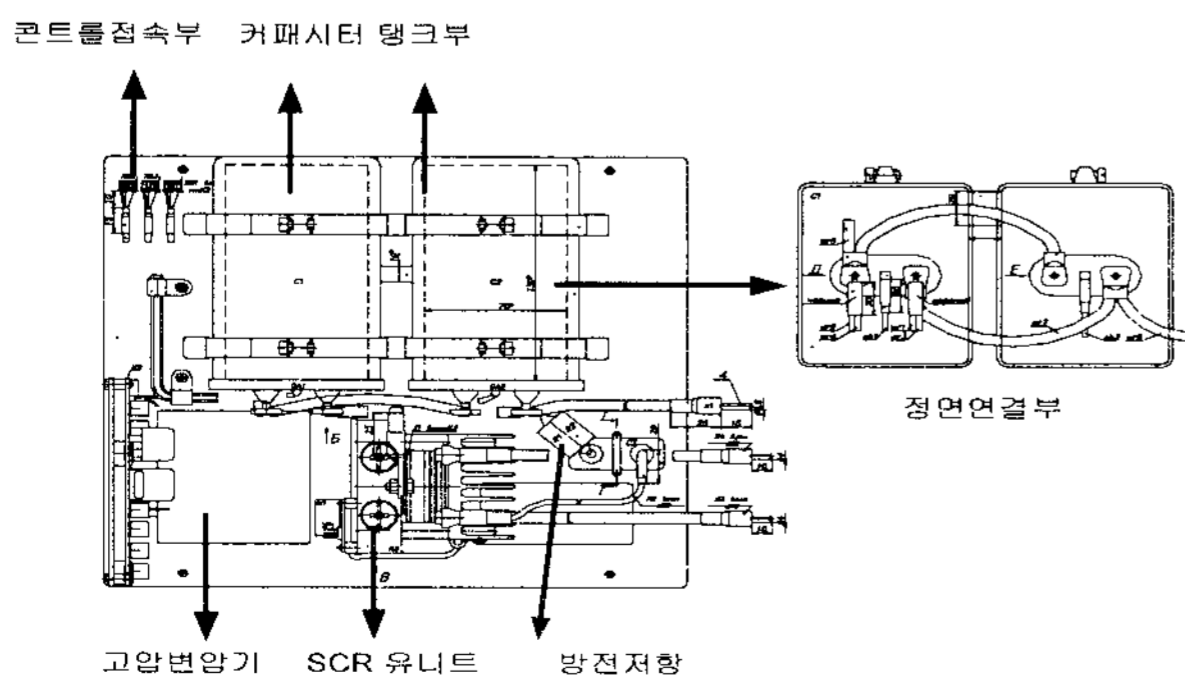

Figure. 3. 2^{loop} 3^{pulsed} Do energy storing accumulation chapter of variableness magnetic tent probe nerve system

Is composing by 2^{loop} 3^{pulsed} variableness magnetic pocket insertion style magnetic nerve system that apply probe just for urinary incontinence treatment. Is composing 2loop 3pulsed variableness for main point fine crack treatment by pocket insertion style own nerve system that own apply Probe just. First, if explain circuit that do current mobile warfare kind compensation function, proposed inverter is achieved by diode for stoppage and switching element in power circuit of existent grass bridge way inverter.

$$i = \iint_s \mathcal{G}.ds(A) \text{-----(1)}$$

$$i = \iint_s \mathcal{G}.ds = \frac{-dq}{dt} \text{-----(2)}$$

Is connecting both direction switching element to center tap of dc power. If examine cancer (Arm) voltage by On of each switch to investigate level of output voltage in proposed inverter, priority Q2 all if become B point voltage Vd A that is dc power supply voltage do, and Q4 all if become B point voltage zero (zero) become. In the case of voltage of A point, Q1 by addition of both direction switch all if become A point voltage Vd A that is dc power supply voltage do, and Q3 all if become A point voltage except thing which clean bright atmosphere (zero) becomes Q5 all if become structure of power circuit that A point voltage become half Vd/2 of dc power supply voltage have . 0 (zero), Vd/2, 3 voltage of Vd of A point voltage according to On of each switch appear, and B point voltage 0 (zero), 2 voltage of Vd appear.

$$q = \iiint_{vol} \rho v dv(c) \text{-----(3)}$$

Voltage that can form by output voltage of inverter according to On of each switch get into voltage difference of two cancers, and 0, Vd/2, Vd, 5 of - Vd/2 - Vd of output voltage Vo of proposed inverter appear.

$$i = \iint_s \mathcal{G}.ds = \frac{-d}{dt} \iiint_{vol} \rho v dv \text{-----(4)}$$

Therefore, can receive 0, Vd, fire bridge inverter output voltage that voltage of - 3 of Vd appear. First, form output voltage using number dc power supply voltage to form output voltage by output voltage and these voltage using capacitor voltage for half partial pressure of dc power.

$$\iint_s \mathcal{G}.ds = - \iiint_{vol} \frac{\partial \rho v}{\partial t} dv \text{-----(5)}$$

$$\iint_s \mathcal{G}.ds = \iiint_{vol} div \mathcal{G} dv \text{-----(6)}$$

Therefore, keep harmonic ingredient such as inverter since beak that variation index sets dc power to the class in 0.5 lows and form same output voltage because raising variation index by double in inverter of these way.

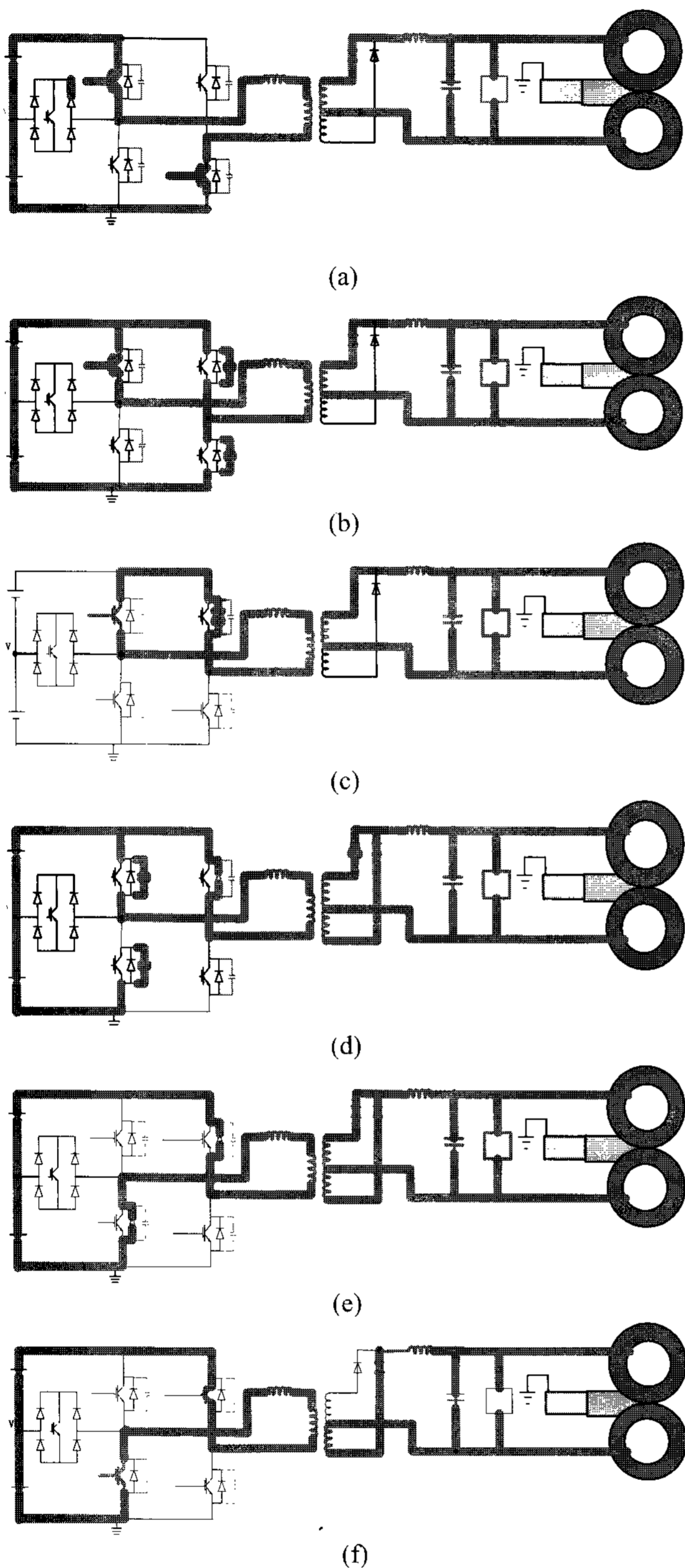

Figure . 4 Operation mode

Variation power of a number can become control system that more than 0.5 can reduce sharply harmonic ingredient more in grass bridge inverter that use same dc power supply voltage that use dc power supply voltage and half voltage of dc power supply voltage that is voltage of minute practical use capacitor. When variation index is 0.5 to embody switching function by such mode, half value of do peak of modulation wave by the carrier wave that decide to grow and carrier wave that impose offset of the size degree existent sine-wave PWM carrier wave stand face to face . Also, recognize switching bow

by above carrier wave priority period of ten days and formed switching function. When use equal switching frequency and dc power supply voltage, need harmonic analysis for two inverters to prove excellent of control system that see as that compare harmonic ingredient. By next time, if explain circuit including Battery tank department to charge, full bridge inverter is consisted of center, and inverter does ZVS (Zero Voltage Switching) action by La's help.

The first of transformer of this charger is threaded to charger, and the second transmits electric power because is threaded and close up part that is threaded to the first when charge to the second to own curer. The second is diode stoppage circuit and L-C filter and Battery is connected by multiple on C both end. Live part can select power failure kind charge (Constant Current Charging), constant voltage charge (Constant Potential Charging) and 3 charge way of Taper charge according to situation. Voltage of inverter that act by ZVS are controlled by phase-shift.

$$\iiint_{vol} \nabla g dv = - \iiint_{vol} \frac{\partial \rho v}{\partial t} dv \text{ -----(7)}$$

Charging current decides according to Battery's proper form by way that chisel current charge keeps charging current as is fixed. Battery must watch well charge situation because there is danger of damage and so on of electrode place for gas occurrence if charge overflows. If monad voltage rise so, must finish charge. In charger charging current by 20 ~ 50 [A] charge completion voltage by 57 ~ 60 [V] establishment possible. If taper charge charges by maximum current at charge early by way to control charging current according to Battery charge state while charge and voltage per cell get into 2.1 [V] degrees, do current to become minimum current if voltage per cell get into 2.6 [V] degrees beginning to reduce size of current. Maximum current is decided according to Battery proper form. It is known that ratio of maximum current and minimum current is the taper rate.

If taper is small, charge time is shortened and if there is end point that danger of battery's temperature upswing is and taper is big, while danger of battery temperature rise is less, but there is shortcoming that charge time is prolonged. Control of interchange voltage controls transformer primary voltage to control dc output voltage and current and transformer primary voltage is controlled by status change. If suppose that inverter does ideal hard-switching action, voltage of A point picture of(A) with become and voltage of B point (me) with become and voltage between A-B (all) with become . Mean value of voltage between A-B changes by A, B phase difference θ . This 2loop 3pulsed variableness in apply that pocket insertion style own nerve system own just Probe transformer separation possible must. The first, the second is detached and approximates when charge and forms transformer usually. Used zero voltage switching (ZVS : Zero Voltage Switching) technologies to reduce switching dissipation and cross fire. Because both end

voltage of on/off city switch element of switch element are "0" in ZVS, electric power damage can decrease and reduce greatly switching noise because rise of voltage is slow.

$$\Delta \cdot g = - \frac{\partial \rho v}{\partial t} \text{-----(8)}$$

This time, L-C resonant circuit in off state of up-and-down switch element is consisted all and voltage of switch element both end change through resonance phenomenon. If voltage polarity changes, current passes by D3. While current passes by D3, turn on F3. When current passes by D3, switch both end voltage amount to 0 almost and clean bright atmosphere voltage on consist.

$$\Delta \cdot J = 0 \text{-----(9)}$$

When current is passing by F3, zero voltage on/off consist in equal form to when put out F3. Fluxion dv/dt of capacitor both end voltage is depended on flowing current and L-C value. IGBT's gate signal breeds in UC 3875.

2.2 Treatment pulse probe

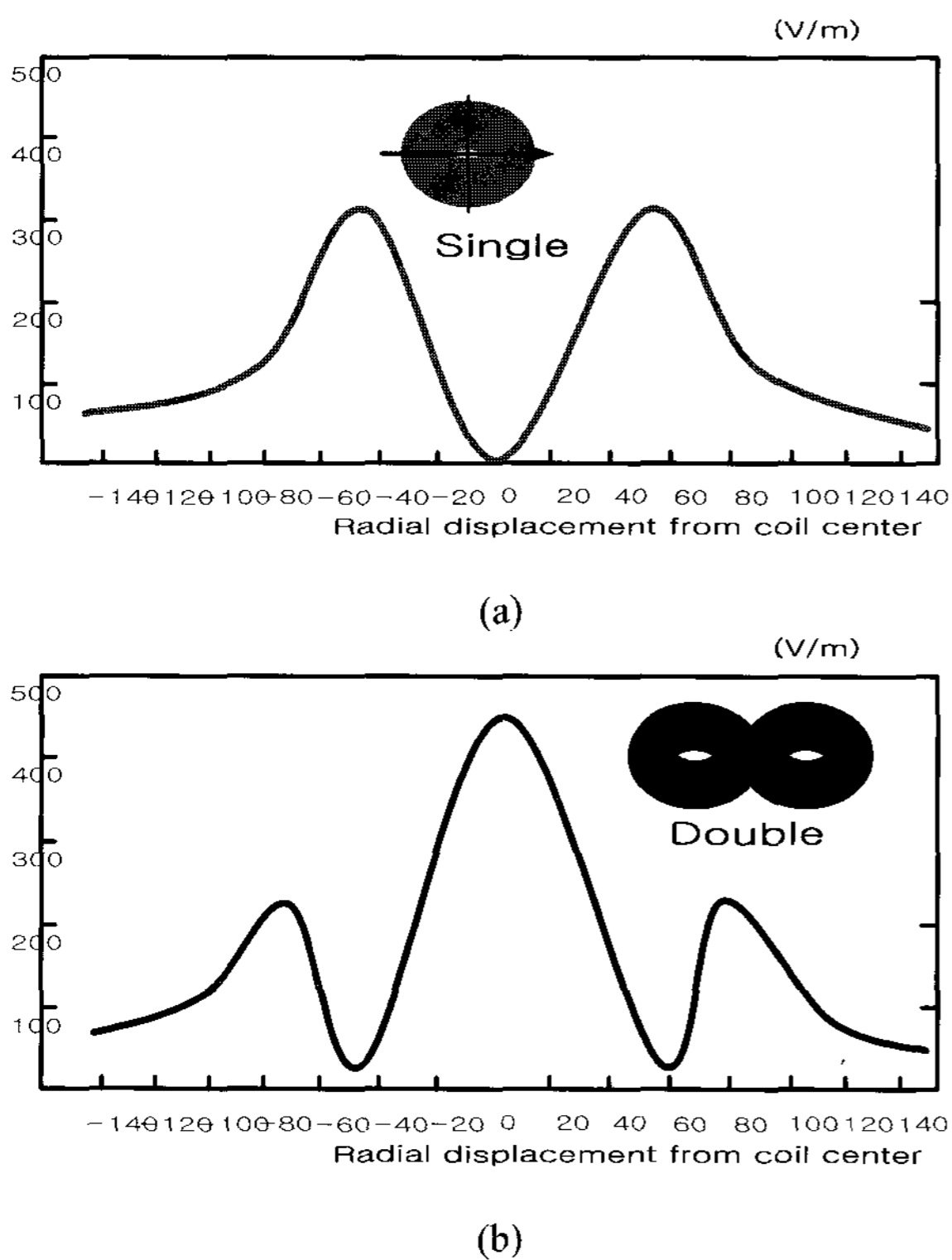

Figure. 5 Treatment probes of several shape and measurement value of energy by disease treatment

Figure 5 of(a) in urinary incontinence, prostate of(b) figure 5, sphincter, nervous system of(c) figure 5, cervical vertebra, headache, retrogression arthritis, ligament damage of(d) figure 5, rheumatism arthritis, tip of a twig nerve etc. proper Probe's treatment pulse come out . Specially, limitation capacitor energy and E Peak value are function during zero-to-peak's rise time.

Value 100ms' time rise raise that general. Inductance L = 20 uHs and resistance = 50 mohms. capacitor C reaches from 20 to 600 uFs. Current form is = 150 mses as biphasic and number t of thin film awarding. Energy - continuance curved line is leveled far about continuous value for very short pulses that is not looked although.

Though there is 2 stimulation flag type, it is single pulse devices and devices that repeat that lay stimuli's train in 60Hz in 1. Can have that is added to their single pulsation devices could use to drive 1 coil in pulsations that is classed by 1 to 1 ms module. There are see devices are paired-pulse or quadruple-pulse stimulants. 2 stimulant unit can be used to drive become independent coils stimulate other local together at the same time or continuously continuous. By peculiar coil cooling, speed of stimulation difference can be limitless. Specially, woman could observe in a special quality experiment that 2^{loop} 3^{pulses} are valid than 1 loop.

2.3 Pocket stabilization-insertion style probe manufacture by dress

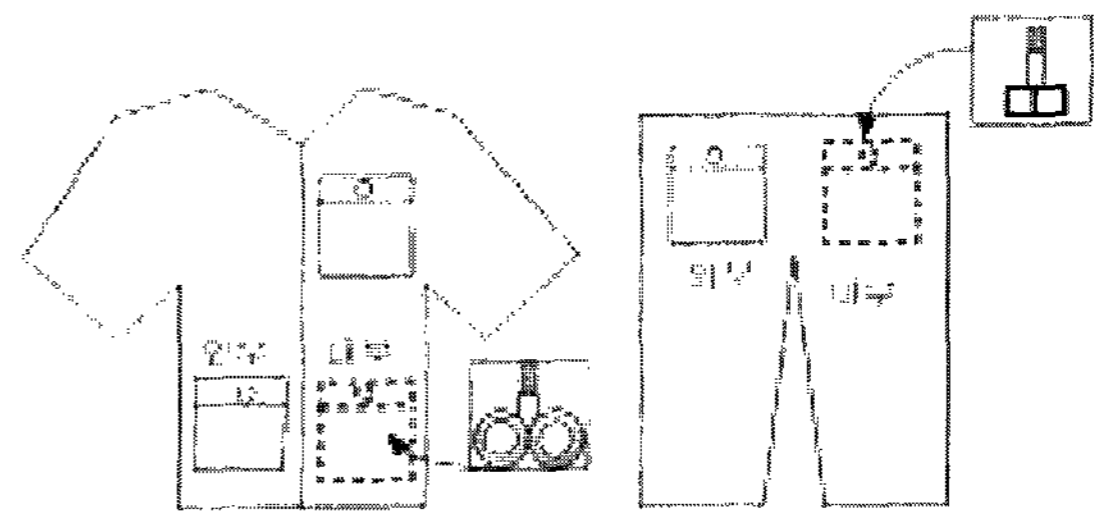

Figure . 6 Mode for male

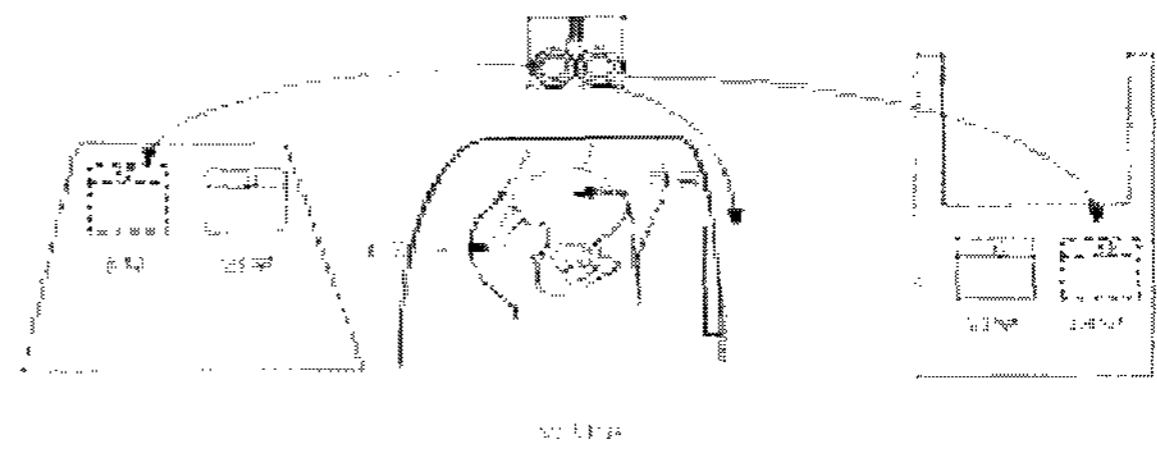

Figure . 7 Mode for female

8 - shaped coils can concentrate more concentrative electric field than circulation coil. And can do better control in space wide area of stimulation. It is easy that another important development drives stimulation consecutively in 1 - 50Hz. Model of stimulation that magnetize is important racket in research of machines of venue, degree and magnetic pole analysis and design of experiments, it is become an effective tool.

Though model embodiment separates by important 2 branches, neural response result by calculation of electromagnetic fields and electricity discharge that look on naked eye by flowing in priority, coil forms impalpably into thin slices Current I (t) in coil produces magnetic field B that is derived by electric field E. B through coil indeed, lungs roof mortification E line,

high position right side can explain that appear in central gyroscope side form in hemisphere really. 2 pyramidal axon is seen with typical direction of intracranial E. Electric field influences in transmembrane possibility. It guides by area thin film depolarisation and promulgation of neurone. Usually, shape of electric field is derived by fibroid material being depended on form of induction coil. Express conductivity structure about position and direction of coil, electricity of fibroid material about fibroid material. Theoretical connection ring is consisted by interaction arrangement.

$$\int_V J^p(r)E(r)dv = \frac{-di(t)}{dt} \int_C b_j(r')da(r') \quad (10)$$

Here, display r before outside when is ϕ by the first current breakup JP in volume conductor V inside that BJ approximates in top.

$$\phi = \int_C B_j da = \int_V LJ^p dv \quad (11)$$

Two calculations same that geometrically achieve can. Interaction can hold for long and inhomogeneous space and aeolotropy space with permittivity and permeability tensors that balance.

$$E(r) = \frac{-di(t)}{dt} L(r) \quad (12)$$

Tangent, circulation coil for side number of transfer have, and on 10 turns and lower part of coil depth of familiar face surface of coils is 15mm being circulation coil and 8 - shapeds, diameter 40mm and dI/dt of coils that erect. Generally, pocket fixing by dress, insertion style probe trousers-formal dress style or skirt fixed wherever insertion and stabilization possible. Also, probe is ideal by treatment pulse more than 2 loof, more than 3 pulses.

2.4 various probes' function and performance embodiment

Because general probe is manufactured in general electric wire form in figure 9 but this research uses metal kind (a pipe), treatment Probe according to radius value is inexpensive and cooling is very superior. See it is very epoch-making that make probe using, specially, same pipe etc. Brought satisfiable result in function and performance, manufacture, setting, all sides. Design in probe's archetype capsule form in figure 10 that is improved Probe in reply and design and manufactured so that valve interval cooling water may flow. This brought still more superior result than Probe that develop before.

Could satisfy in function, performance, cost price, manufacture, setting, cooling, all sides.

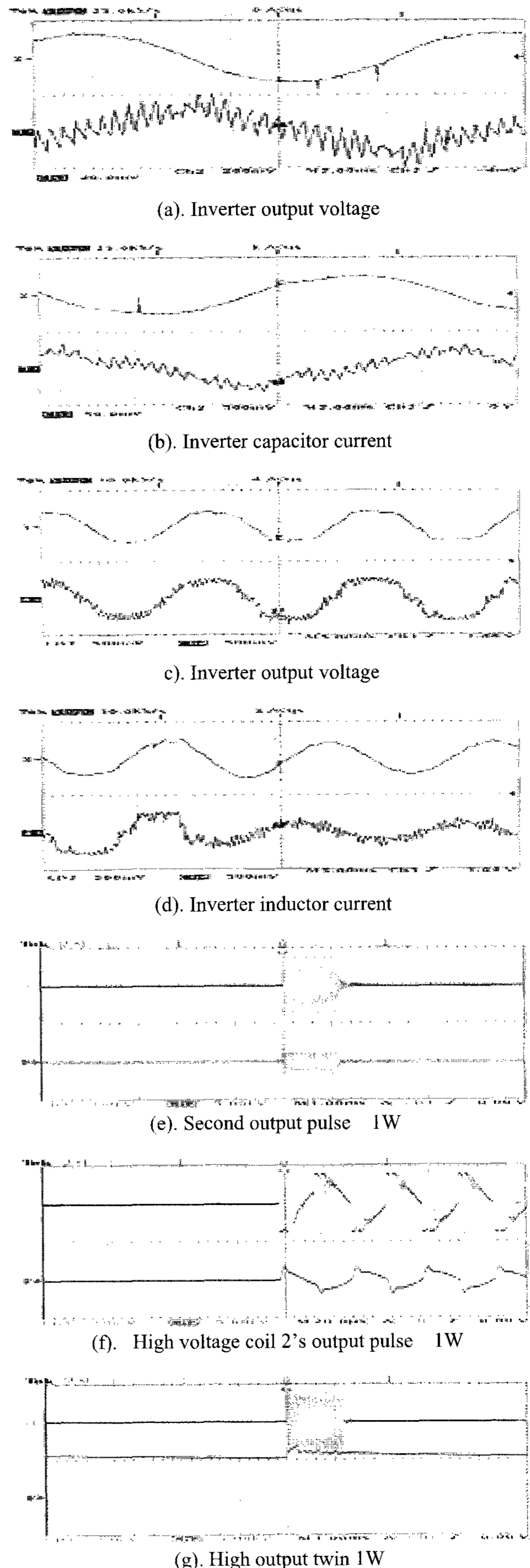

Figure. 8 Experiment Waveform

III. EXPERIMENT RESULT

Figure 9 is single mode, and energy displays 2.0 uH. Figure 10 is displaying $2^{loop}3^{pulsed}$ Mode. Figure 11, 12 displays energy when is side and side $2^{loop}3^{pulsed}$. Figure 13 displays energy when is your model single mode. Figure 14 is displaying your model $2^{loop}3^{pulsed}$ pulsed relationship energy. As a result, is being expose that $2^{loop}3^{pulsed}$.

A energy is much on the whole than single mode and effect is big to treatment and so on. Figure . 15 Intensity that increase & energy on the whole refer . Figure.16 compares and displayed output charge voltage etc.. in $2^{loop}3^{pulsed}$ course $1^{loop}2^{pulsed}$ pulsed mode. Latented latency time more than course $1^{loop}2^{pulsed}$ $2^{loop}3^{pulsed}$ enemy by more efficient thing experiment . Wish to approach by software red to paper next term.

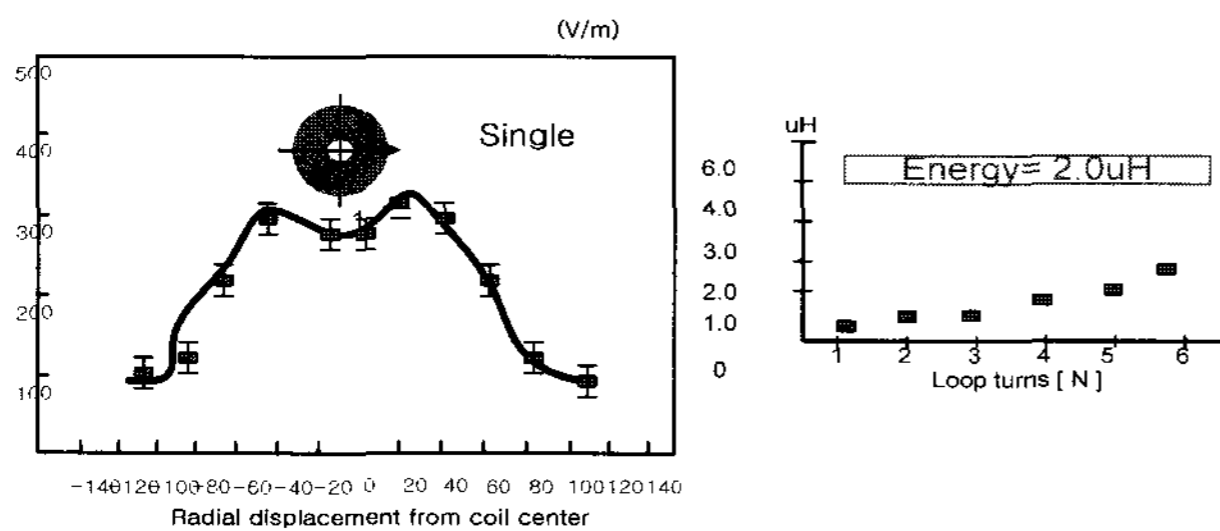

Figure. 9 $1^{loop}2^{pulsed}$ mode output [circle]

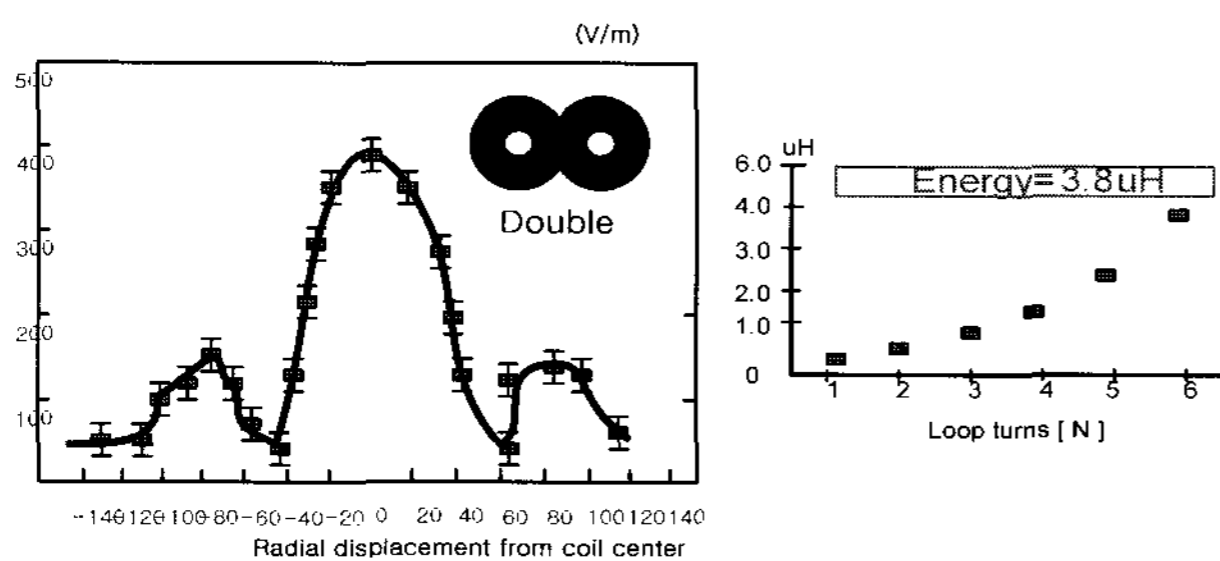

Figure. 10 $2^{loop}3^{pulsed}$ mode output

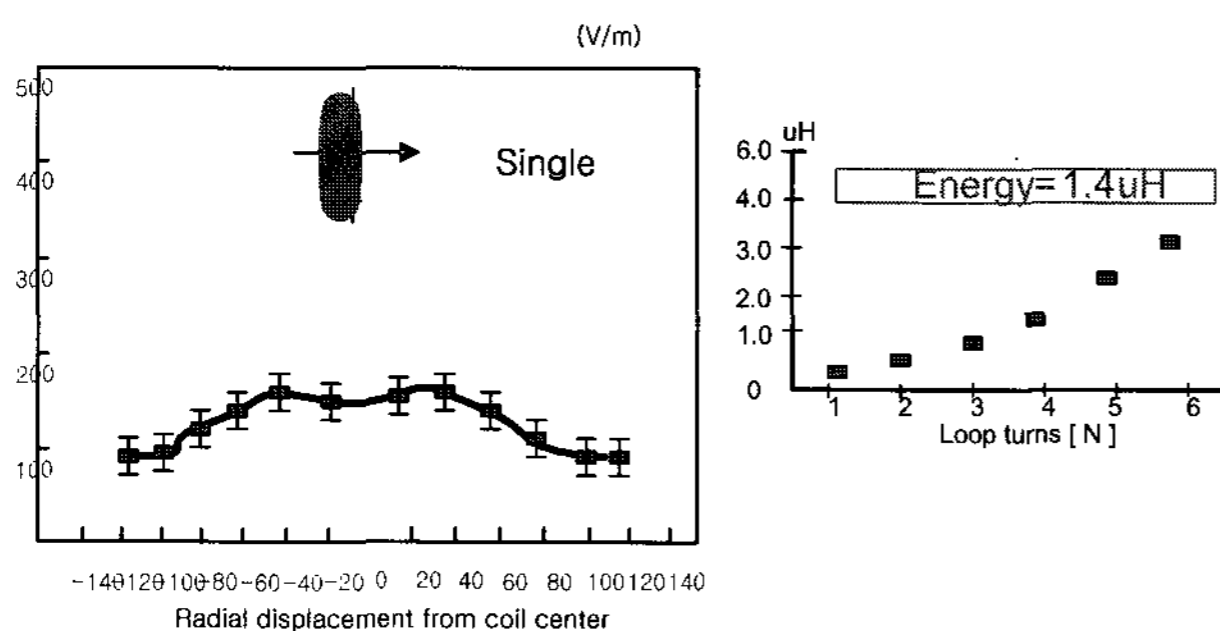

Figure. 11 $1^{loop}2^{pulsed}$ mode output [side circle]

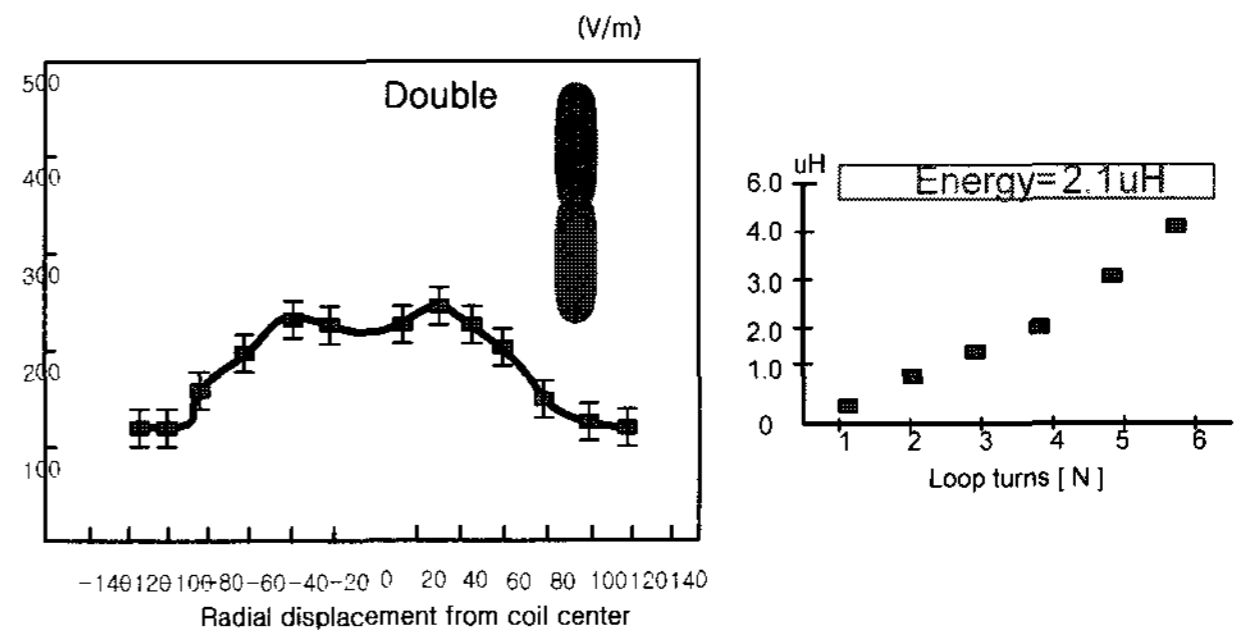

Figure. 12 $2^{loop}3^{pulsed}$ mode output

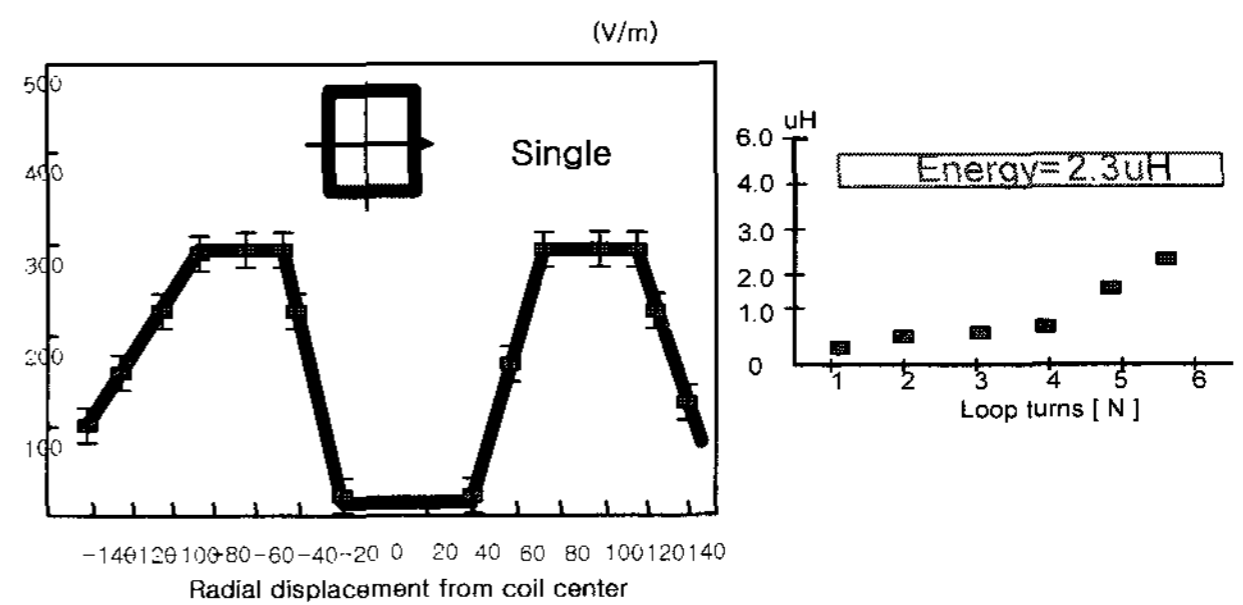

Figure. 13 $1^{loop}2^{pulsed}$ mode output [square]

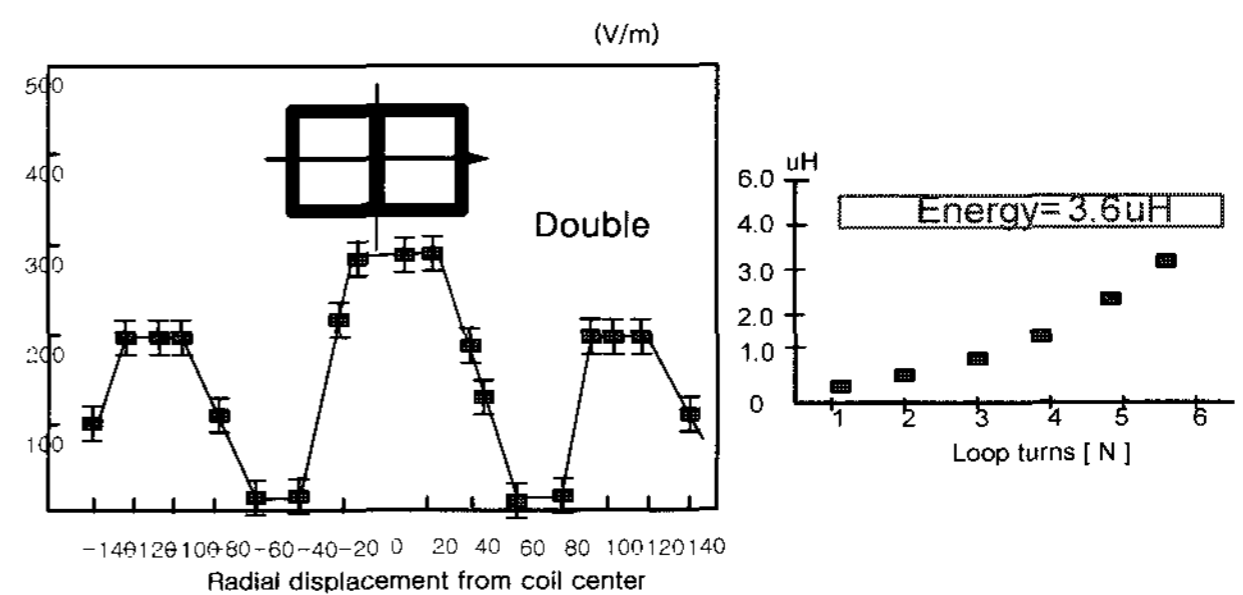

Figure. 14 $2^{loop}3^{pulsed}$ mode output

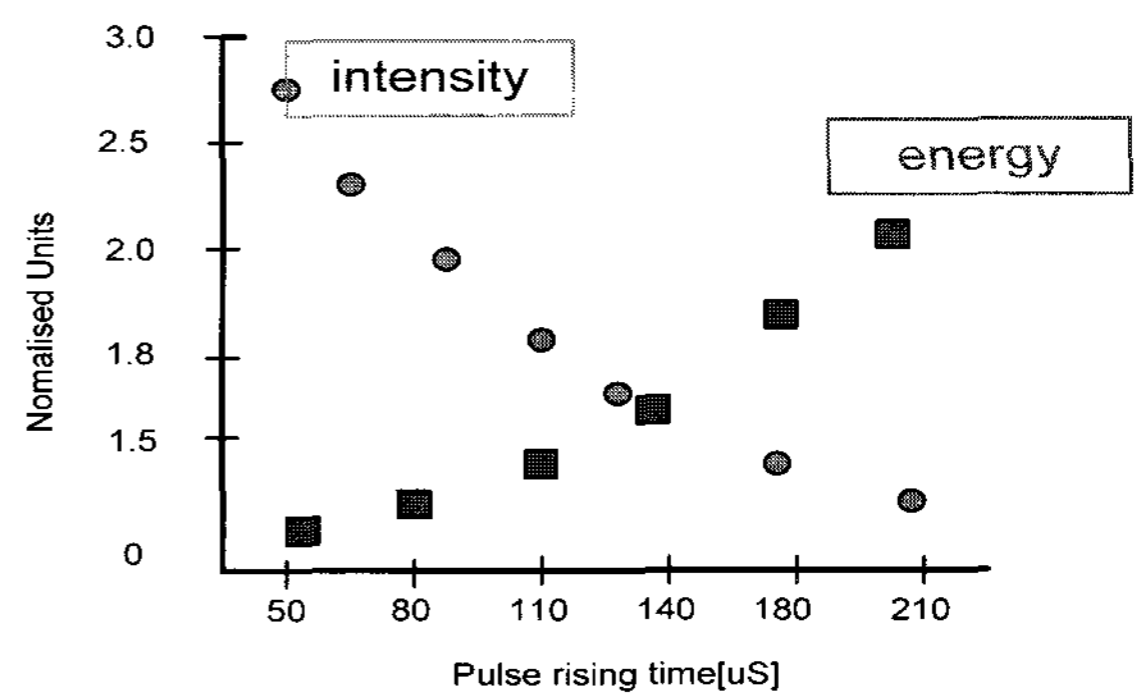

Figure. 15 Intensity & Energy

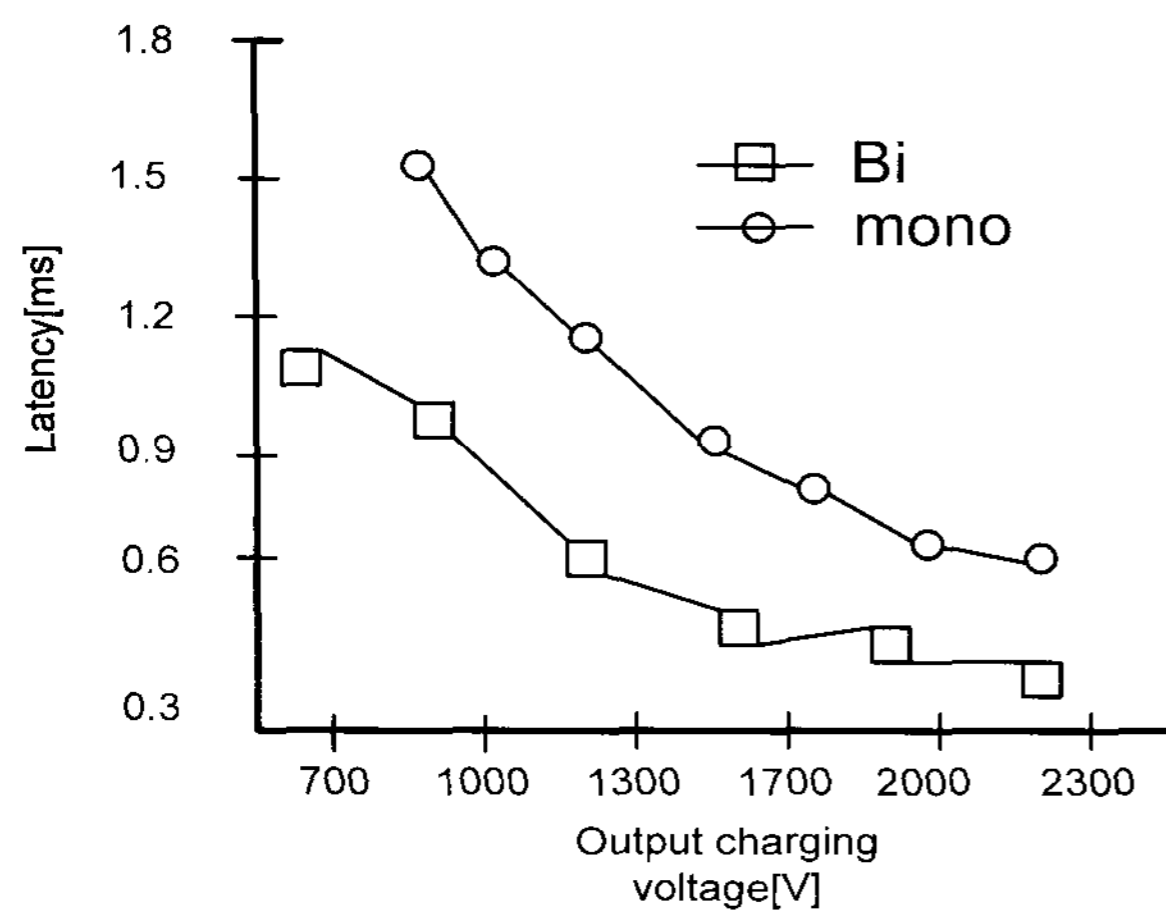

Figure 16. Bi($2^{\text{loop}3 \text{ pulsed}}$) & Mono($1^{\text{loop}1 \text{ pulsed}}$)

IV. CONCLUSION

Result that study own nerve curer for treatment lacteal gland current generation and current of ion for development to urinary incontinence, prostate, constrictor, nerve system, cervical inflammation, headache, retrogression arthritis, ligament damage, rheumatism arthritis, peripheral neuro etc. conclusively .

Can classify by 4. First, embodied compensate mobile warfare kind, and do self-discipline occurrence chapter is full-bridge. Communication with PC is available, it composed stimulation mourning by pocket fixing, insertion style, and confirmed various action loops an experiment. By next time, could confirm correct treatment probe woman and man disease person. By next time, can add to apron, general dress according to disease and derived so that healing may be possible naturally. Finally, because treatment probe's cooling composition composes by act of negative plate form, manufacture is easy and cooling designed for easy direction. More superior result of cooling appeared than existing in incidental and ingredients, cooling efficiency, composition, complexity, convenience etc. that expense and composition manufacture very straightforwardly and experimental by 2 - Tank ways.

REFERENCES

- [1] 1. Libet, B., Gleason, C. A., Wright, E. W. & Pearl, D. K. Time of conscious intention to act in relation to onset of cerebral activity (readiness-potential): the unconscious initiation of a freely voluntary act. *Brain* 106, 623–642 (1983).
- [2] Barker, A. T., Jalinous, R. & Freeston, I. L. Noninvasive magnetic stimulation of human motor cortex. *Lancet* 1, 1106–1107 (1985).
- [3] Amassian, V. E. *et al.* Suppression of visual perception by magnetic coil stimulation of human occipital cortex. *Electroencephalogr. Clin. Neurophysiol.* 74, 458–462 (1989).
- [4] Haggard, P. & Eimer, M. On the relation between brain potentials and the awareness of voluntary movements. *Exp. Brain Res.* 126, 128–133 (1999).
- [5] Fink, G. R. *et al.* The neural consequences of conflict between intention and the senses. *Brain* 122, 497–512 (1999).
- [6] Fulwiler CE, Saper CB. Subnuclear organization of the efferent connections of the parabrachial nucleus in the rat. *Brain Res Rev* 1984;7:229–59.
- [7] Handforth A, Degiorgio CM, Schacter SC. Vagus nerve stimulation therapy for partial-onset seizures, a randomized active-control trial. *Neurology* 1998; 51:48
- [8] Hauser WA, Hesdorffer DC. *Epilepsy: frequency, causes, and consequences.* New York: Demos, 1990:151
- [9] Blakemore, S. J., Wolpert, D. M. & Frith, C. D. Why can't you tickle yourself *Neuroreport* 11, 11–16 (2000).



Whi-Young Kim

Acquire Dong A university Dept. of Electronic Engineering master's degree in 1991 and worked 12 years in corporation. Is working until present being issued by sailing on the same college medical treatment start of work learning and a full-time instructor in 2000. Acquired doctor's degree with Pusan university Electric engineering in 2001, and interest field is heroism bionics connection. Specially, is doing electric power laser, supersonic waves, a magnetic field, treatment equipment and diagnosis equipment etc.