

Nest Box Preference by Secondary Cavity-Nesting Birds in Forested Environments

Choi, Chang-Yong*, Hyun-Young Nam¹, Eun-Jae Lee, Ok-Sik Chung, Yong-Su Park,
Jong-Koo Lee, Jee-Yun Hyun and Woo-Shin Lee

Department of Forest Sciences, Seoul National University, Seoul 151-921, Korea

¹*School of Biological Sciences, Seoul National University, Seoul 151-742, Korea*

ABSTRACT: We placed and monitored 2,137 nest boxes to determine how the size of the entrance hole and the box placement influenced nest box selection by secondary cavity-nesting birds and to derive recommendations for the use of nest boxes for management of cavity-nesting birds in forested environments. A total of 566 pairs of seven bird species used the nest boxes from 1997 to 2006, 562 of which were secondary cavity-nesters. Sympatric tits such as varied tits (*Parus varius*), great tits (*P. major*), and marsh tits (*P. palustris*) were common breeding birds in nest boxes, and showed clear preferences for 4.0 cm, 3.5 cm and 3.0 cm nest holes, respectively. Tree sparrows (*Passer montanus*) and Eurasian nuthatches (*Sitta europaea*) preferred 4 cm and 3.5 cm holes, respectively. We did not detect selection for the directional orientation for the entrance hole, but the birds appeared to avoid nest boxes that faced steep or gentle upward slopes and those less than 1.8 m from the ground. These results are probably related to avoidance of disturbance and predation. We suggest that diverse species can be supported by the placement of nest boxes with entrance holes of various sizes and that specific species can be targeted by selecting the hole sizes preferred by those species. To attract secondary cavity-nesters, managers should avoid placing nest boxes close to the ground and facing hills. This study also suggests that careful selection and placement of nest boxes is needed to avoid biases in research using nest boxes.

Key words: Entrance hole, Forested environments, Nest boxes, Preference, Secondary cavity-nesting birds

INTRODUCTION

A bird's choice of nest site can influence the bird's life history, and a species' choice of a nest site may directly influence where it can live and with which species it can coexist (Brightsmith 2005). Many characteristics of cavities affect the probability of selection as a nest site by cavity-nesting birds, including the location of cavities within a habitat (Rendell and Robertson 1990), the cavity size (Rendell and Robertson 1993), and the directional orientation of the cavity's entrance (Raphael 1985, Balgooyen 1990). The number and quality of cavities in an area, inter- and intra-specific interactions (predation, parasitism, competition, etc.) and environmental conditions (microclimate, wind, sunlight, etc.) are also important factors affecting nest site selection (Martin et al. 2004).

Unlike primary cavity-nesters (i.e., birds that excavate their own nest cavities), secondary cavity-nesters (i.e., birds that use cavities excavated by others) often suffer from limited nest sites and have less control over cavity production and modification (Martin 1993, Wiebe and Swift 2001). Therefore, secondary cavity-nesters display

unpredictable breeding patterns (Martin 1993) and may select the most opportune nest site without regard for cavity size or microhabitat. Nevertheless, in studies of nest site preference among secondary cavity-nesting birds with large sample sizes, we expect to detect a preference for specific nest characteristics. Although results from nest box studies must be interpreted carefully because nest boxes may not be accurate models for natural cavities (Robertson and Rendell 1990, Newton 1994), nest boxes are often used in studies and the management of cavity-nesting species (Purcell et al. 1997, Mannan et al. 1996).

Nest boxes have been used in many studies on the breeding biology of forest birds in Korea, but most of these studies did not consider the factors affecting nest box selection by cavity-nesting birds. Won et al. (1965) and Kim et al. (1967) concluded that nest boxes with a 3cm hole were appropriate for tits (*Parus* spp.), and Kim (1978) outlined a brief set of general guidelines regarding nest box selection by cavity-nesting birds. Choi and Kim (1987) also discussed nest box use by several cavity-nesters. However, the previous studies used relatively small numbers of nest boxes and none of them focused in detail on the pattern of nest box selection by

* Corresponding author; Phone: +82-2-880-4766, Fax: +82-2-875-6229, e-mail: subbuteo@hanmail.net

each species. We monitored the selection of nest boxes by secondary cavity-nesters in 2,137 nest boxes in several forested environments. We focused on the orientation of the entrance, the height of the nest box, the inclination of terrain around the nest box and, most of all, on the preferred size of an entrance hole. The objectives of this study are (1) to determine how the entrance hole and nest box placement influences nest box selection by secondary cavity-nesting birds, (2) to produce a general guide for effective nest box placement, and (3) to derive a set of guidelines for management of secondary cavity-nesters applicable to forested environments in Korea.

MATERIALS AND METHODS

From 1997 to 2006, we placed and monitored 2,137 nest boxes on Mt. Cheonggye, Mt. Gwanak, Mt. Umyeon and Mt. An in Seoul; in the Gwangneung Forest in Gyeonggi Province; on Mt. Sambong and Mt. Cheongtae in Gangwon Province; on Mt. Yeongin and Mt. Huiiri in Chungnam Province; on Mt. Saembong in Chungbuk Province; and in Mt. Jiri National Park in Jeonnam Province (Fig. 1). The nest boxes, which had entrance holes ranging from 3.0 cm to 7.0 cm, were made of wood for the most part, although we did use some made of cement and recycled plastics. Nest boxes were set out

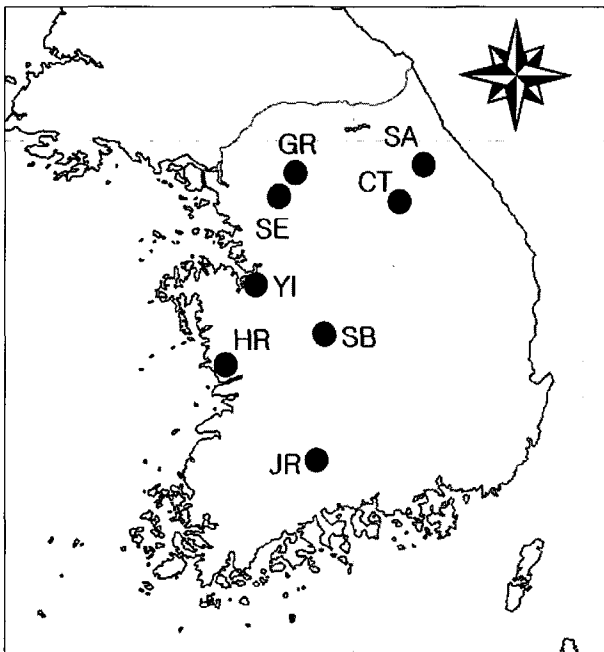

Fig. 1. Map showing locations of study sites. SE: Seoul (Mt. Cheonggye, Mt. Gwanak, Mt. Umyeon and Mt. An), GR: Gwangneung forest, SA: Mt. Sambong, CT: Mt. Cheongtae, YI: Mt. Yeongin, HR: Mt. Huiiri, SB: Mt. Saembong, and JR: Mt. Jiri national park.

from October to January, and we repeatedly visited the boxes from March to June to determine breeding status and conditions. We regarded the laying of the first egg as the start of breeding, but breeding success was not considered. We monitored occupancy of nest boxes during the following breeding seasons only after nest box placement in each study site.

We recorded general information on the breeding birds using the nest boxes, and measured the body masses of great tits (*Parus major*), marsh tits (*P. palustris*) and varied tits (*P. varius*) to determine social dominance among tit species. We also measured the size and orientation of the entrance hole, the height of the nest boxes and the angle of inclination of the land on which the nest box was placed. The entrance orientation was measured using a hand-held compass and the measured orientations were grouped into eight categories (North 337.5°~022.5°, Northeast 022.5°~067.5°, East 067.5°~112.5°, Southeast 112.5°~157.5° South 157.5°~202.5°, Southwest 202.5°~247.5°, West 247.5°~292.5° and Northwest 292.5°~337.5°). The height of the entrance hole was measured using a tape measure and the resulting measurements were grouped into six categories ranging from 1.0 m to 3.4 m above the ground at intervals of 40 cm. The angle of inclination was categorized as steep (>50°), gentle (30°~49°), slight (10°~29°) and flat (<10°).

We used Jacobs' index of preference (Jacobs 1974) to calculate the preference index (PI) for each nest box type, and categorized the resulting PI's into five groups: strong preference ($1.00 \geq PI > 0.60$), moderate preference ($0.60 \geq PI > 0.20$), no preference ($0.20 \geq PI \geq -0.20$), moderate avoidance ($-0.20 > PI \geq -0.60$), and strong avoidance ($-0.60 > PI \geq -1.00$).

We pooled data from all sites because examination of local differences in patterns of nest box use was beyond the scope of this study, and we were unable to analyze the effects of interactions among variables due to the lack of complete information on environmental variables for each nest box. The statistical analysis focussed on some major species because of small sample sizes for many species. We used Chi-square tests to determine differences between expected and observed values. All statistics were calculated using SAS 9.1 (SAS Institute Inc.) and values are presented as mean \pm SD.

RESULTS

Species Composition

Over the ten-year period, 566 of the 2,137 nest boxes were used by seven bird species during the breeding seasons. Most of the birds (562 of 566 pairs) using the nest boxes were secondary cavity-nesters; the four others were all Daurian redstarts (*Phoenicurus aureoreus*), which are not cavity-nesters. Varied tits (*Parus varius*)

and great tits (*P. major*) were the most common breeders using the nest boxes although marsh tits (*P. palustris*) often used them too (Table 1).

Hole Size Preference

The birds including the three common tit species used nest boxes with specific hole sizes more frequently than expected (Table 1; pooled: $\chi^2=10.05, p=0.037$; *P. varius*: $\chi^2=63.42, p<0.001$; *P. major*: $\chi^2=55.71, p<0.001$; *P. palustris*: $\chi^2=193.20, p<0.001$). Varied tits showed a moderate preference for nest boxes with a 4 cm hole (PI=0.283) and moderate avoidance of boxes with a 3cm hole (PI=-0.524). Great tits preferred nest boxes with a 3.5 cm hole (PI=0.277) and avoided boxes of any other hole size. Marsh tits most frequently used nest boxes with a 3 cm hole (PI=0.472), but showed moderate or strong avoidance for all other hole sizes (Fig. 2). In addition, tree sparrows preferred a 4 cm hole (PI=0.292), and Eurasian nuthatches used nest boxes with a 3.5 cm hole most frequently (PI=0.370; Fig. 3). The mean diameter of the entrance holes was 3.76 ± 0.41 cm for varied tits (*P. varius*: $n=201$), 3.52 ± 0.41 cm for great tits (*P. major*: $n=197$), 3.06 ± 0.16 cm for marsh tits (*P. palustris*: $n=143$), and 3.73 ± 0.32 cm for tree sparrows (*P. montanus*: $n=15$). The mean and preferred sizes of the entrance holes increased as the body mass of these three tits increased (Fig. 4; *P. varius*: 45.33 ± 1.04 g, $n=3$; *P. major*: 38.71 ± 1.80 g, $n=12$; *P. palustris*: 28.00 ± 2.22 g, $n=9$).

Preference for Nest Box Placement

In this study, cavity-nesting birds selected nest boxes at random with regard to orientation ((Table 2, $n=504, df=7, \chi^2=1.223, p=0.9904$) and showed no preference for any specific orientation (Fig. 5; $0.2 > PI > -0.2$). However, they showed moderate avoidance

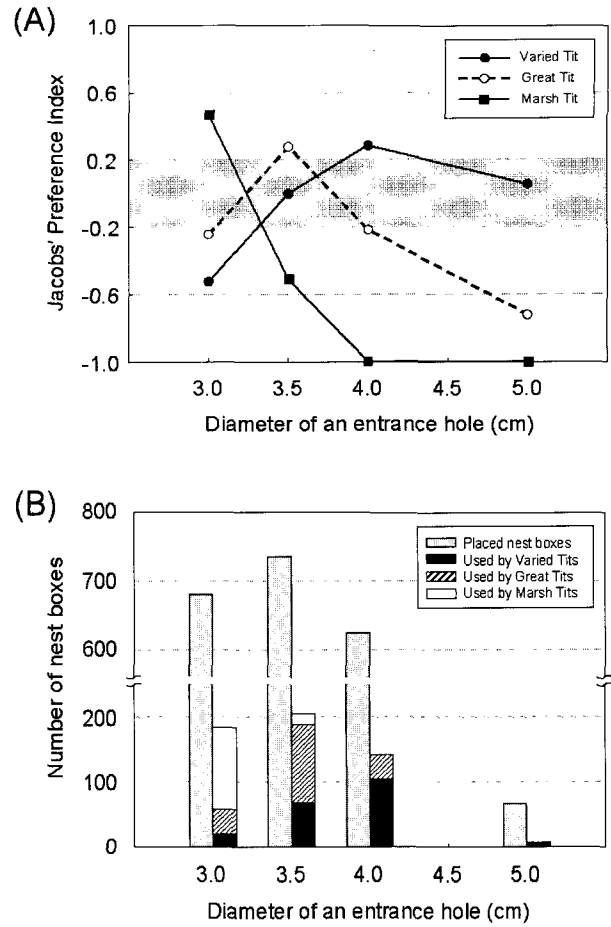

Fig. 2. (A) Jacobs' preference indices for entrance hole sizes of nest boxes, and (B) the number of nest boxes of each size placed and used by three tit species; varied tits (*Parus varius*; $n=201$), great tits (*Parus major*; $n=197$), and marsh tits (*Parus palustris*; $n=143$).

Table 1. Number and percentage of nest boxes placed and used in forested areas by species and by diameter of entrance hole

	Diameter of entrance hole					Total	χ^2	p value
	3.0 cm	3.5 cm	4.0 cm	5.0 cm	7.0 cm			
Placed nest boxes	680 (31.8%)	737 (34.5%)	624 (29.2%)	67 (3.1%)	29 (1.4%)	2,137 (100%)		
Used nest boxes	188 (33.2%)	215 (38.0%)	152 (26.9%)	8 (1.4%)	3 (0.5%)	566 (100%)	10.05	0.037
<i>Parus varius</i>	20 (10.0%)	69 (34.3%)	105 (52.5%)	7 (3.5%)	0 (0.0%)	201 (100%)	63.42	<0.001
<i>Parus major</i>	38 (19.3%)	120 (60.9%)	37 (18.8%)	1 (0.5%)	1 (0.5%)	197 (100%)	55.71	<0.001
<i>Parus palustris</i>	127 (88.8%)	16 (11.2%)	0 (0.0%)	0 (0.0%)	0 (0.0%)	143 (100%)	193.20	<0.001
<i>Passer montanus</i>	1 (6.7%)	6 (40.0%)	8 (53.3%)	0 (0.0%)	0 (0.0%)	15 (100%)	-	-
<i>Sitta europaea</i>	0 (0.0%)	3 (75.0%)	1 (25.0%)	0 (0.0%)	0 (0.0%)	4 (100%)	-	-
<i>Phoenicurus auroreus</i>	0 (0.0%)	1 (25.0%)	1 (25.0%)	0 (0.0%)	2 (50.0%)	4 (100%)	-	-
<i>Parus ater</i>	2 (100%)	0 (0.0%)	0 (0.0%)	0 (0.0%)	0 (0.0%)	2 (100%)	-	-

($PI=-0.205$) of nest boxes facing steep and gentle upward slopes (more than 30°) although this was not statistically significant (Fig. 6, Table 3; $n=362$, $df=6$, $\chi^2=3.085$, $p=0.7981$). The breeding birds' selection of nest boxes placed at different heights differed significantly from chance (Table 4; $n=599$, $df=5$, $\chi^2=15.104$, $p=0.0099$),

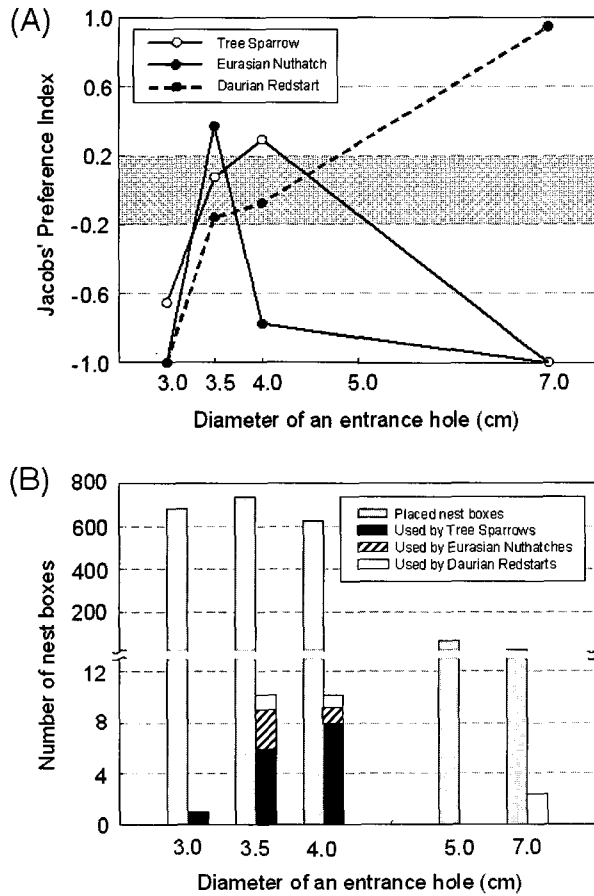

Fig. 3. (A) Jacobs' preference indices for entrance hole sizes of nest boxes, and (B) number of nest boxes of each size placed and used by tree sparrows (*Passer montanus*; $n=15$), Eurasian nuthatches (*Sitta europaea*; $n=4$) and Daurian redstarts (*Phoenicurus auroreus*; $n=4$).

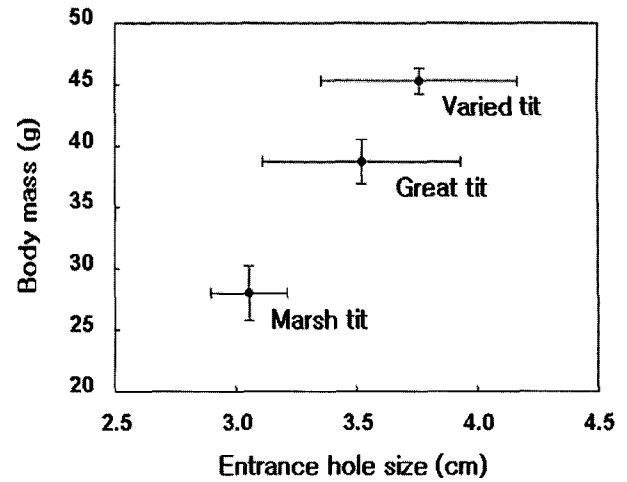

Fig. 4. Body mass and mean hole sizes of active nest boxes of three tit species: the varied tit (*Parus varius*), the great tit (*Parus major*), and the marsh tit (*Parus palustris*).

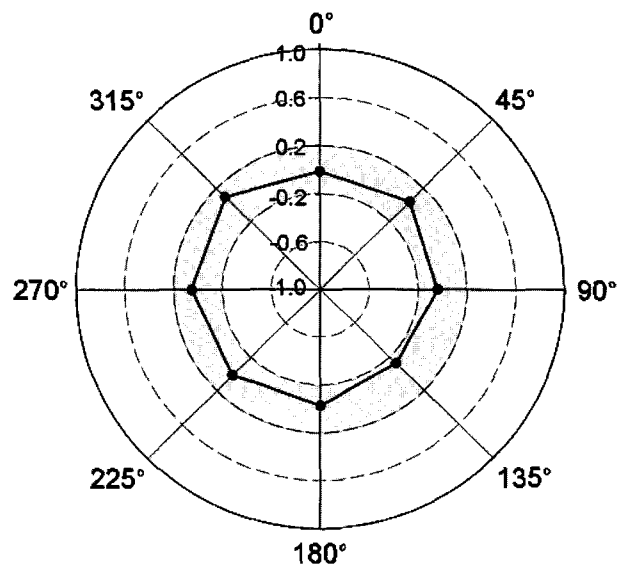

Fig. 5. Jacobs' preference indices of secondary cavity-nesting birds for the compass orientation of entrance holes in forested areas.

Table 2. Number and percentage of nest boxes placed and used facing different compass orientations in forested areas

	Compass orientation of the entrance hole								Total	χ^2	p value
	N 337.5°~ 022.5°	NE 022.5°~ 067.5°	E 067.5°~ 112.5°	SE 112.5°~ 157.5°	S 157.5°~ 202.5°	SW 202.5°~ 247.5°	W 247.5°~ 292.5°	NW 292.5°~ 337.5°			
Placed nest boxes	62 (12.3%)	47 (9.3%)	82 (16.3%)	58 (11.5%)	80 (15.9%)	49 (9.7%)	68 (13.5%)	58 (11.5%)	504 (100%)		
Used nest boxes	12 (12.0%)	10 (10.0%)	15 (15.0%)	9 (9.0%)	15 (15.0%)	10 (10.0%)	15 (15.0%)	14 (14.0%)	100 (100%)	1.223	0.9904

and they apparently avoided nest boxes placed lower than 1.8 m above ground (Fig. 7; 1.0 m~1.4 m: PI=-0.235; 1.4 m~1.8 m: PI=-0.313).

DISCUSSION

Species Composition

This study shows that tits (Genus *Parus*) are the most frequent users of nest boxes, which agrees with the results of previous stu-

dies on nest boxes in Korea (Kim et al. 1967, Woo and Kim 1985, Choi and Kim 1987, Kim and Woo 1987, Lee and Kim 1996, Kim et al. 2000). Tits are the most abundant and widespread species in Korean forested environments, and they play an important role in forest ecosystem as major consumers of insects (Won et al. 1965, Kim et al. 1967, Eguchi 1979, Cowie and Hinsley 1988, Lee and Kim 1996). Consequently, tits are useful for pest control, and nest

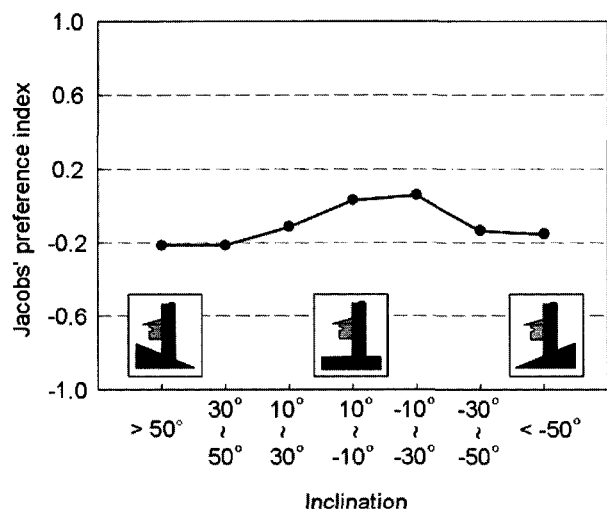

Fig. 6. Jacobs' preference indices of secondary cavity-nesting birds for the inclination where the nest boxes were placed in forested areas.

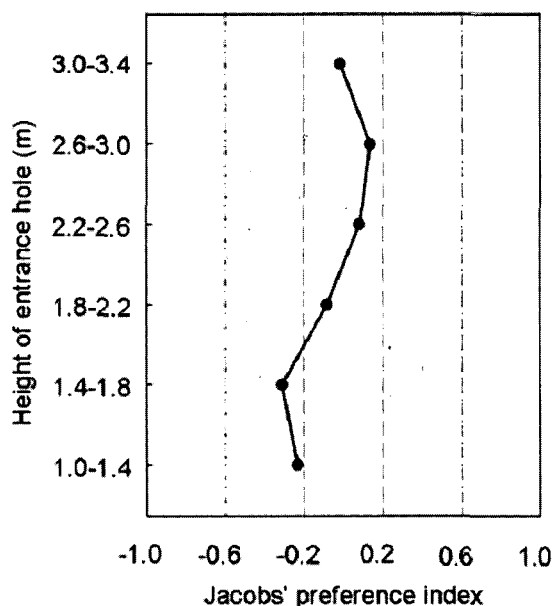

Fig. 7. Jacobs' preference indices of secondary cavity-nesting birds for the height of nest boxes in forested areas.

Table 3. Number and percentage of nest boxes placed and used at different inclinations in forested areas

	Inclination							Total	χ^2	p value
	Steep upward (>50°)	Gentle upward (30°~49°)	Slight upward (10°~29°)	Flat area (<10°)	Slight downward (10°~29°)	Gentle downward (30°~49°)	Steep downward (>50°)			
Placed nest boxes	8 (2.2%)	18 (5.0%)	94 (26.0%)	160 (44.2%)	64 (17.7%)	12 (3.3%)	6 (1.7%)	362 (100%)		
Used nest boxes	3 (1.6%)	7 (3.8%)	54 (29.5%)	87 (47.5%)	26 (14.2%)	4 (2.2%)	2 (1.1%)	183 (100%)	3.085	0.7981

Table 4. Number and percentage of nest boxes placed and used at different heights in forested areas

	Height of nest boxes (m)						Total	χ^2	p value
	1.00~1.39	1.40~1.79	1.80~2.19	2.20~2.59	2.60~2.99	3.00~3.39			
Placed nest boxes	38 (6.3%)	110 (18.4%)	56 (9.3%)	196 (32.7%)	142 (23.7%)	57 (9.5%)	599 (100%)		
Used nest boxes	9 (3.9%)	22 (9.6%)	18 (7.9%)	88 (38.4%)	71 (31.0%)	21 (9.2%)	229 (100%)	15.104	0.0099

boxes are often used to increase breeding populations of tits (Purcell et al. 1997, Mannan et al. 1996).

Varied tits (*Parus varius*) occupied many active nest boxes in this study, but this result does not correspond to those of previous studies in Korea (Woo and Kim 1985, Choi and Kim 1987, Kim and Woo 1987, Kim et al. 2000). Previous studies suggested that great tits (*P. major*), marsh tits (*P. palustris*) and coal tits (*P. ater*) are the major users of nest boxes in forested areas. Only Lee and Kim (1996) noted that the varied tit may be a major nest box user in certain conditions, but they suggested no explanation for this pattern. Although there is no information on the population trend of the varied tit in Korea, we believe that these results can be partially explained by examination of the sizes of the entrance holes used in these studies. Unlike most other studies, Lee and Kim (1996) used nest boxes with entrance holes of several different sizes, many of which were large enough for varied tits. The previous studies probably produced biased results because many used holes of only a single size, which generated a more favorable environment for some species than for others.

Hole Size Preference

In this study, marsh tits, great tits and varied tits showed clear preference for 3.0 cm, 3.5 cm and 4.0 cm holes respectively, although they are sympatric and closely-related species. This suggests that their nesting niches differ due to adaptation, competition and niche partitioning. This result corresponds to those of previous studies on foraging niches and behaviors in those tits (Park 2005, Park et al. 2005).

Tree sparrows showed a preference for 4 cm nest box holes, but interspecific competition with the varied tit may be reduced because the sparrow generally inhabits villages and edges of forests while the varied tit breeds in forested areas (Won 1981, Choi and Kim 1987). The Daurian redstart is an open-cup nester and prefers larger entrance holes that create similar breeding conditions to open nests.

The size of an entrance hole will affect exposure to solar radiation and prevailing winds, and access by large predators and competitors. Entrance hole sizes have been described as affecting the rate of successful breeding in the nest boxes along with other factors such as the adult's age, and the height and placement of the nest boxes (Purcell et al. 1997, Wiebe and Swift 2001). As cavity size is an important variable affecting species occupancy (Evans et al. 2002), we suggest that the size of entrance holes also plays an important role in the nest box selection of secondary cavity-nesters. Selection of a nest box with optimal entrance hole size may maximize the chances of successful breeding. Won et al. (1965), Kim et al. (1967), Kim (1978), and Choi and Kim (1987) suggested that smaller entrance holes are better for secondary cavity-nesting birds

(e.g., the nest boxes with a 3 cm hole fit well to all tits species). However, based on the results presented here, we argue that the use of nest boxes with many different hole sizes should support a greater diversity of species.

Alatalo and Moreno (1987) suggest that body size and mass can be used as indices of social dominance in tits. Apparently, dominance among closely-related species can affect the nest selection of secondary cavity-nesters, but we were unable to show the results of competition and dominance in this study. Although Won (1981) suggested that great tits lead mixed-species flocks in wintering seasons, however, varied tits are larger in body mass than the other two tits, so we suggest that the varied tit may be the socially dominant species among tits in Korea.

Preference for Nest Box Placement

Previous studies on several cavity-nesters (Dennis 1971, Inouye et al. 1981, Korol and Hutto 1984) showed that some species have a preferred orientation for nest entrances or cups. The usual explanation for this behavior is that birds derive thermoregulatory benefits from specific orientations; e.g., by avoiding direct exposure to wind or sun (Dennis 1971, Stauffer and Best 1982, Korol and Hutto 1984) but other explanations such as acoustic properties have also been suggested (Mennill and Ratcliffe 2004).

Although several studies provided evidence for preferred cavity orientations in secondary cavity-nesters (Lumsden 1986, Minegishi 1994), other studies have not (Stauffer and Best 1982). A recent study concluded that (1) no relationship exists between nest entrance orientation and directional orientation, and that (2) nest entrances are non-randomly oriented and individuals regulate the nest microclimate by nesting in cavities oriented relative to prevailing winds or solar radiation (Mennill and Ratcliffe 2004). No preference with regard to directional orientation was detected in this study, although we did not focus on the effects of microclimate. Our results correspond to those of other recent studies (see Rendell and Robertson 1994).

Secondary cavity-nesters avoided nest boxes less than 1.8 m above the ground, which is similar to the result of a previous study in Japan (Minegishi 1996) that showed that the great tit preferred nest boxes set at heights of 1.7 m to 2.0 m. There was no significant difference in the breeding success of birds in nest boxes placed at different heights (Minegishi 1996). However, the nest boxes placed lower are usually more vulnerable to human disturbance and predators. Won et al. (1965), Kim et al. (1967) and Kim (1978) also noted that a nest box placed close to the ground may be more vulnerable to human damage. The nest height is often cited as the most important factor influencing predation risk (Nilsson 1984, Li and Martin 1991). Li and Martin (1991) suggested that secondary

cavity-nesters suffered greater nest predation than primary cavity-nesters because they were forced to use lower holes. Therefore, the selection of nest boxes at specific heights may result from a trade-off between the energetic costs of flying up to high nest boxes and the risk of breeding failure from predation or disturbance at low nest boxes.

In this study, secondary cavity-nesting birds avoided nest boxes facing upward slopes of greater than 30° inclination, and preferred a flat or slight downward inclination. There was no evidence for the cause of this preference, but it may be related to the height of nest boxes and their distance from ground. Upward slopes may reduce distance between the ground and the entrance hole of nest boxes, which creates a similar effect to that of lower-placed nest boxes in terms of disturbance and predation. A nest box facing the ground may also have disadvantages in acoustic properties, which is an important factor affecting selection of nest hole orientation (Mennill and Ratcliffe 2004).

Management Implication and Further Researches

It may be possible to support the breeding of a more diverse set of cavity-nesters by placing nest boxes with various entrance hole sizes, and more favorable breeding conditions for specific species can also be created by controlling the size of nest box entrance holes. The size of an entrance hole affects nest box selection by birds and may ensure more successful breeding and greater fitness of cavity-nesting birds. Therefore selection of the hole size of nest boxes can be a part of management measures for breeding populations of secondary cavity-nesting birds in forest environments. To improve rates of nest box occupancy by secondary cavity-nesters, it may be also helpful to avoid placing nest boxes close to the ground or facing a steep incline. In addition, greater consideration should be paid to the interpretation of research results in studies using nest boxes because patterns of occupancy may be biased when nest boxes with a single hole size are used. For example, in this study, varied tits avoided nest boxes with small entrance holes, and this fact may be a principle cause for underestimates of nest box occupancy of the varied tit in previous studies.

Nest boxes have been regarded as tools for pest control and for management of cavity-nesting species in forested environments in Korea (Woo and Kim 1985, Choi and Kim 1987, Kim and Woo 1987, Lee and Kim 1996), but it is very difficult to estimate the effect of nest boxes on populations of cavity-nesting birds. Breeding pairs of secondary cavity-nesters increased in number after nest box placement, suggesting that nest boxes may be useful for short-term forest management (Woo and Kim 1985, Choi and Kim 1987, Kim and Woo 1987, Lee and Kim 1996). Nevertheless, the long-term effects of nest box placement remain uncertain; furthermore, a nest

box may be an 'ecological trap' that functions to 'attract and kill'.

Recent attention has focused on nest predation in natural conditions, but only a few researchers have examined the influence of cavity characteristics on nesting success in natural cavities (Christman and Dhondt 1997). We still need intensive comparative studies considering inter- and intra-species interactions and comparing the breeding success of cavity-nesting birds in natural cavities and nest boxes to understand long-term effects of nest box placement.

ACKNOWLEDGEMENTS

Many members of the bird watching club (Wild Bird Society) of Seoul National University were involved in the laborious field-work for this study. We also thank Dr. Wee-Haeng Hur, Mr. Seong-Ho Han, Mr. Chang-Seok Han, Mr. Sang-Do Lee and many students from the Department of Forest Sciences at Seoul National University. This study was partially supported by the LG Evergreen Foundation.

LITERATURE CITED

- Alatalo RV, Moreno J. 1987. Body size, interspecific interactions, and use of foraging sites in tits (Paridae). *Ecology* 68: 1773-1777.
- Balگووین TG. 1990. Orientation of American kestrel nest cavities revisited. *J Raptor Res* 24: 27-28.
- Brightsmith DJ. 2005. Competition, predation and nest niche shifts among tropical cavity nesters: ecological evidence. *J Avian Biol* 36: 74-83.
- Choi JS, Kim JS. 1987. Ecological studies on the inhabitation of artificial nests by wild birds: especially in Gyeongnam province. *J Korea For Soc* 76: 109-118.
- Christman BJ, Dhondt AA. 1997. Nest Predation in Black-capped Chickadees: how safe are cavity nests? *Auk* 114: 769-773.
- Cowie RJ, Hinsley SA. 1988. Feeding ecology of great tits (*Parus major*) and blue tits (*Parus caeruleus*), breeding in suburban gardens. *J Anim Ecol* 57: 611-626.
- Dennis J. 1971. Species using red-cockaded woodpecker holes in northeastern South Carolina. *Bird Banding* 42: 79-87.
- Eguchi K. 1979. Food and food consumption of nestling tits, *Parus major minor* and *Parus varius varius*, in the evergreen broad leaved forests in northern Kyushu. *J Yamashina Inst. Ornithol* 54: 1-18.
- Evans RM, Lank DB, Boyd WS, Cooke F. 2002. A comparison of the characteristics and fate of barrow's goldeneye and bufflehead nests in nest boxes and natural cavities. *Condor* 104: 610-619.
- Inouye RS, Huntly NJ, Inouye DW. 1981. Non-random orientation of Gila Woodpecker nest entrances in saguaro cactus. *Condor* 83: 88-89.
- Jacobs J. 1974. Quantitative measurements of food selection. *Oecologia* 14: 413-417.

- Kim SW. 1978. Needs of nest box settlement. *Nature Conserv* 22: 24-29.
- Kim SW, Kim CH, Kim WK. 1967. Breeding biology and chick food of Korean great tit (*Parus major wladivostokensis*) in Korea. *Res Rep For Res Inst* 12: 87-98.
- Kim SJ, Lee DP, Koo TH. 2000. A comparative study on the breeding biology of great tit *Parus major* using nest box in the Younggwang and Gwangju areas. *Korean J Orni* 7: 33-41.
- Kim SW, Woo HC. 1987. Studies on the attracting bird to forest (II): ecology of coal tit. *Res Rep For Res Inst* 35: 123-129.
- Korol JJ, Hutto RL. 1984. Factors affecting nest site location in Gila Woodpeckers. *Condor* 86: 73-78.
- Lee WS, Kim SW. 1996. Foods and nest boxes of wildbirds in natural and degraded ecosystem. *Korean J Orni* 3: 43-50.
- Li P, Martin TE. 1991. Nest-site selection and nesting success of cavity-nesting birds in high elevation forest drainages. *Auk* 108: 405-418.
- Lumsden HG. 1986. Choice of nest boxes by tree swallows, *Tachycineta bicolor*, house wrens, *Troglodytes aedon*, eastern bluebirds, *Sialia sialis*, and European starlings, *Sturnus vulgaris*. *Can Field-Nat* 100: 343-349.
- Mannan RW, Conner RN, Marcot B, Peek JM. 1996. Managing forestlands for wildlife. In: *Research and management techniques for wildlife and habitats*, 5th ed (Bookhout TA, ed). The Wildlife Society, Bethesda, pp 689-721.
- Martin K, Aitken KEH, Wiebe KL. 2004. Nest sites and nest webs for cavity nesting communities in interior British Columbia, Canada: Nest characteristics and niche partitioning. *Condor* 106: 5-19.
- Martin TE. 1993. Evolutionary determinants of clutch size in cavity nesting birds: Nest predation or limited breeding opportunities? *Am Nat* 142: 937-946.
- Mennill DJ, Ratcliffe LM. 2004. Nest cavity orientation in black-capped chickadees *Poecile atricapillus*: do the acoustic properties of cavities influence sound reception in the nest and extra-pair matings? *J Avian Biol* 35: 477-482.
- Minegishi N. 1994. Difference of nest box directions used by tit species and Tree Sparrows. *Strix* 13: 173-177.
- Minegishi N. 1996. Difference of nest box use in relation to the height by tit species and Tree Sparrows. *Strix* 14: 73-79.
- Newton I. 1994. The role of nest sites in limiting the numbers of hole-nesting birds: a review. *Biol Conserv* 70: 265-276.
- Nilsson SG. 1984. The evolution of nest-site selection among hole-nesting birds: The importance of nest predation and competition. *Ornis Scand* 15: 165-175.
- Park CR. 2005. Tree species preference and inter-specific difference of foraging maneuver, trees and location among four canopy-dwelling birds at high-elevation temperate deciduous forest in Mt. Jumbongsan. *Integrative Biosciences* 9: 41-46.
- Park CR, Lee WS, Hino T. 2005. Temporal changes of foraging niches among breeding tits (Paridae) in a Korean temperate deciduous forest. *Ornis Fenn* 82: 81-88.
- Purcell KL, Verner J, Oring LW. 1997. A comparison of the breeding ecology of birds nesting in boxes and tree cavities. *Auk* 114: 646-656.
- Raphael MG. 1985. Orientation of American Kestrel nest cavities and nest trees. *Condor* 87: 437-438.
- Rendell WB, Robertson RJ. 1990. Influence of forest edge on nest-site selection by tree swallows. *Wilson Bull* 102: 634-644.
- Rendell WB, Robertson RJ. 1993. Cavity size, clutch-size and the breeding ecology of Tree Swallows *Tachycineta bicolor*. *Ibis* 135: 305-310.
- Rendell WB, Robertson RJ. 1994. Cavity-entrance orientation and nest-site use by secondary hole-nesting birds. *J Field Ornith* 65: 27-35.
- Robertson RJ, Rendell WB. 1990. A comparison of the breeding ecology of a secondary cavity nesting bird, the Tree Swallow (*Tachycineta bicolor*), in nest boxes and natural cavities. *Can J Zool* 68: 1046-1052.
- Stauffer DF, Best LB. 1982. Nest-site selection by cavity-nesting birds of riparian habitats in Iowa. *Wilson Bull* 94: 329-337.
- Wiebe KL, Swift TL. 2001. Clutch size relative to tree cavity size in Northern Flickers. *J Avian Biol* 32: 167-173.
- Won PO. 1981. *Illustrated flora and fauna of Korea*. Vol. 25. Avifauna. Ministry of Education, Seoul.
- Won PO, Kim SW, Kim CH. 1965. Breeding biology and chick food of varied tit *Parus varius* in Korea. *Misc Rep Yam Ins Orn* 4: 50-59.
- Woo HC, Kim SW. 1985. Studies on the attracting bird to forest (I): ecology of Korean great tit. *Res Rep For Res Inst* 32: 77-87.

(Received January 11, 2007; Accepted February 15, 2007)