

A Study on the Improvement for Power Quality Problems Caused by Electrical Arc Furnace in Power Systems

Jae-Eon Kim^{1*} and Dae-Seok Rho²

전력계통에서 전기로 부하에 대한 전력품질 개선방안에 관한 연구

김재언^{1*}, 노대석²

Abstract This paper deals with a powerful countermeasure for power quality problems caused by the operation of electrical arc furnace in bulk power systems. The rapid active load fluctuations of electrical arc furnace could produce several problems such as voltage flicker and active power oscillations. The typical methods using only the reactive power compensation have their own limitation in solving the power quality problems caused by active load variations. The coordination of both active and reactive power compensation is required to solve the power quality problems. This paper focuses on the impacts and the dynamic phenomena caused by the active load fluctuation. This paper proposes the optimal algorithm for the active power compensation based on the function of X/R ratio and the concepts for the active power compensation. The results from a case study show that the proposed methods can be a practical tool for the power quality problems in power systems.

Key Words : active power compensation, power quality, electrical arc furnace, energy storage system, FACTS, PSS/E

요약 최근에 전기 아크로의 보급과 그 운전으로 전력계통에 전압플리커 및 유효전력변동과 같은 전력품질상의 문제가 발생될 가능성이 높은 것으로 보고되고 있다. 이 문제를 해결할 수 있는 방법에는 대표적으로 무효전력보상방법이 있는데, 이것은 유효전력변동의 전력품질문제해결에는 한계가 있다. 따라서, 본 논문에서는 이의 해결책으로서 X/R 비율에 근거한 유효전력보상 개념과 그 최적알고리즘을 제안하여 이의 타당성을 모델링과 시뮬레이션을 통하여 검증하였다.

1. Introduction

With the development of industry and the improvement of living standards, better quality in power electric service is required more than ever before. Up to now, the power quality problems have been studied by using only reactive power control methods based on the power electronics devices such as SVC and STATCOMP^{[1]-[3]}. However, the power quality problems by the electrical arc furnace (EAF), which has the rapid fluctuation of both active and

reactive power, cannot be solved completely by using only the reactive compensation methods. Even though reactive power compensation by the existing methods^{[4]-[7]} has been useful in solving the power factor and harmonics, but has been limited in the problems of the voltage flicker and active power fluctuation. The active load may cause the voltage drop and the angle variation at the critical buses. These phase angle variations and active power fluctuations can bring stability problems in the bulk power systems. Even the shaft angle of the generators in the nearby system oscillates because of the fluctuation of the active load. That could be harmful to the generator shaft and reduce the life of generator dramatically. Under these circumstances, to solve the

¹School of Electrical & Computer Engineering, Chungbuk National University

²School of Information Technology, Korea University of Technology and Education

*Corresponding author : Jae-Eon Kim(jekim@cbnu.ac.kr)

problems of the power quality caused by EAF, the active power compensation method needs to be developed. In this paper, the authors have studied the countermeasure for power quality problems caused by the active load as well as the reactive load. The paper is mainly divided into four sections. Chapter II presents the modeling of electrical arc furnace (EAF) and power system including the FACTS/ESS for PSS/E simulations. Chapter III shows the algorithm for X/R ratio calculation in order to analyze the exact reason why the active load affects a power system voltage. Chapter IV proposes theoretical background of the active power compensation for the power quality problems caused by active or reactive load. Especially, the compensation of active power is adapted to solve the voltage oscillation and power fluctuation problems. Chapter V shows the simulation results for the practical power system. The results show that the exclusive reactive power compensation has limitation in solving the power quality problems caused by both the active and reactive load like EAF. The paper also adopts the FACTS/ESS as a powerful means for the compensators with both active and reactive power control capability.

II. Modeling of system parameters

In order to solve the power quality problems caused by rapid fluctuation of active load like EAF, this paper firstly proposes the modeling of electrical arc furnace (EAF) and also presents the power system modeling considering the FACTS/ESS to perform simulations using the PSS/E.

A. Modeling for electrical arc furnace (EAF)

An electrical arc furnace (EAF) has characteristics to change the electrical energy into thermal energy by using electric arc in the furnace. During the arc furnace operation, the random property of arc melting process and the control system will cause serious power quality problems to the power system^[1]. The fundamental component of the current absorbed by the EAF produces the voltage fluctuations called a flicker in the nearby

distribution system. The voltage changes as much as 0.3~1% with frequencies between 2 and 8 Hz^{[1],[8]}. Many methods have been proposed to more precisely represent characteristics of EAF and to study its impacts on power systems. These include the nonlinear resistance models, current source models, voltage source models, the nonlinear time varying voltage source model, nonlinear time varying resistance models, frequency domain models, and power balance models, etc^{[1],[9]}.

This paper presents a practical arc furnace model to solve the power quality problems caused by EAF. The EAF model contains a resistor and a reactor in a random operation mode to display the dynamic characteristics of EAF. Because the focus here is to study the voltage flicker problem solutions by using PSS/E simulation software, the most severe case in the frequencies and magnitudes of EAF voltage fluctuations is considered in the proposed model. The simplified arc model can supply a variation of voltage at about 0.3 ~ 1% at a frequency around 5Hz to PSS/E simulation software. As shown in Fig 1, the simplified model of EAF represents the periodic absorbing of power (active or reactive) from power systems. The instantaneous fluctuations with large amplitudes of active and reactive power are the main source of various power quality disturbances in power systems.

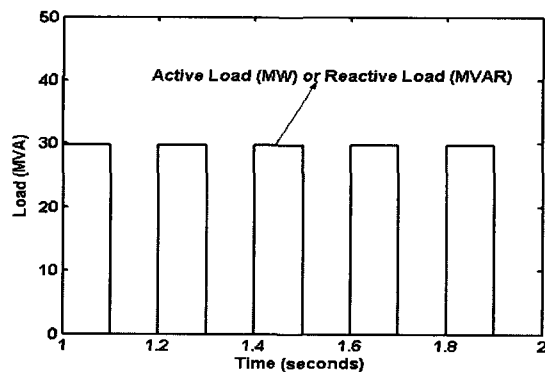

Fig. 1. Simplified model for electric arc furnace

B. Modeling for power systems with FACT/ESS

Several studies on the effect and mitigation of voltage flicker from the operation of an EAF in power systems have been reported. The studies have also discovered that the neighboring distribution network inherently resonate an active oscillation. The power electronic devices being capable of switching at high power have led to the applications of SVC and STATCOM. These devices have been able to solve the power quality problems in distribution and transmission systems by rapidly controlling reactive power $P^{[1]-[3]}$.

However, the power quality problems caused by an EAF are quite different. The rapid fluctuation of active power can cause phase angle variations at critical buses. These phase angle variations and active power fluctuation can cause stability problem in the bulk power system P[10],[11]P. The typical devices only using reactive power compensation have their limitation for dealing with the active power fluctuation, so that this paper adapts FACT/ESS device with active power compensation. The modeling for the power systems interconnected with FACT/ESS is shown in Fig. 2 and the operation mode of FACT/ESS is Fig. 3.

With the advance in both energy storage technologies and the power electronics interface, energy storage systems (ESS) have become as a useful technology for power utilities. The power industry's demands for more flexible, reliable and fast active power compensation devices make the ideal opportunity for ESS applications^{P[4]-[5]}. ESS makes it as a possibility to use active power compensation in solving the power quality problems caused by active load.

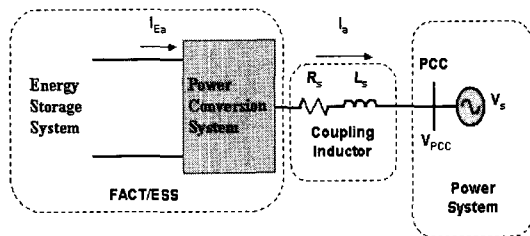

Fig. 2. Modeling for power systems with FACT/ESS

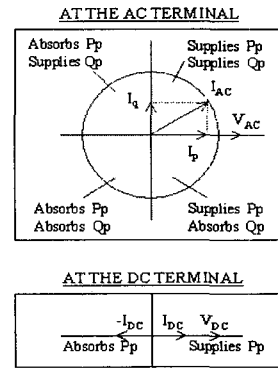

Fig. 3. Operation mode of FACT/ESS

C. Modeling for PSS/E Simulation

The power system simulator for engineering (PSS/E) software, which has the ability to deal with a large-scale power system, is adopted to simulate the power quality problems caused by EAF. Fig. 4 shows the function diagram to perform the dynamic analysis using PSS/E.

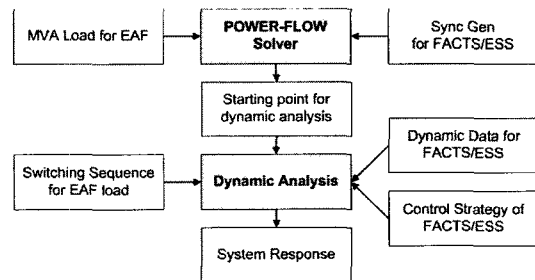

Fig. 4. Diagram for simulation using PSS/E

III. X/R Calculation algorithm

In general, X/R ratio in power systems is very important factor when we study the effect of active and reactive load on the voltage and angle fluctuation in the power system^{P[6]}. The voltage effect of active power is reflected by the real part of system impedance (Thevenin impedance) R_{Bth} . Up to now, it is commonly accepted that the X/R ratio is large value (over 10) enough to ignore the voltage drop caused by the active power. However, the typical approach to calculate X/R ratio could be incorrect by considering only the upper

transformer and transmission line. This paper presents new algorithm to consider all of the system parameters including the load. In other words, the R and X are not only proportional to the impedance of the upper transformers and transmission lines, but to the Thevenin impedance seen from the PCC bus of the entire system as shown in Fig. 5. At the PCC bus, the whole power system can be seen as a power source connected with an active load and a reactive load as shown in Fig. 5 (a). The Thevenin equivalent circuit is shown in Fig. 5 (b).

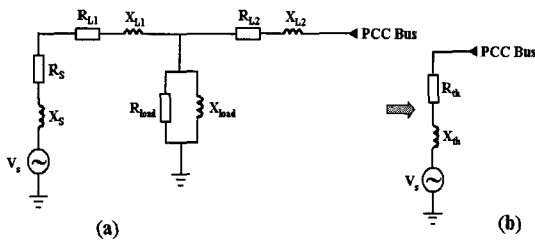

Fig. 5. Thevenin equivalent circuit at PCC bus

The X/R ratio using the Thevenin equivalent circuit can be calculated as follows:

<Step 1> Obtain the total impedance of generators (Z_s) and the equivalent impedance of the transmission lines (Z_L)

<Step 2> Calculate the total power (P_{LE} , Q_{LE})

<Step 3> Assume V_{LLbase} and S_{base}

<Step 4> Calculate the Z_{base}

$$Z_{base} = \frac{V_{LLbase}^2}{S_{base}} \quad (1)$$

<Step 5> Calculate the estimated total load impedance

$$\begin{cases} R_{Load} = \frac{V_{LLbase}^2}{P_L} \\ X_{Load} = \frac{V_{LLbase}^2}{Q_L} \end{cases} \quad (2)$$

<Step 6> Obtain the X/R ratio based on the Fig. 5

Now, the detailed analysis of the X/R ratio on voltage impact is given here. The equivalent impedance (X_n , R_n) shown in Fig. 6 is the Thevenin equivalent of the whole power system looking at PCC bus. U_0 is the source voltage of the Thevenin equivalent circuit. The X/R ratio is not that of the upper transmission line or upper transformer but that of the Thevenin equivalent impedance (X_n , R_n).

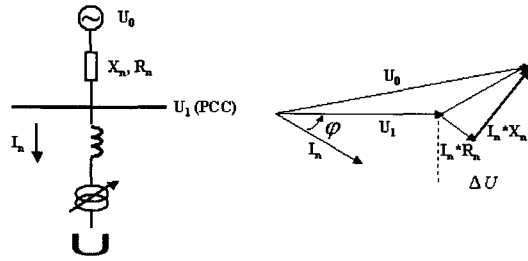

Fig. 6. X/R ratio calculation

In Fig. 6, the voltage drop of EAF is ΔU , which contains a real part ΔU_p and a reactive part ΔU_q . It is obtained by the following equations (3) - (6):

$$\Delta U = \frac{\sqrt{3}}{3} I_n * X_n (\sin \varphi + \frac{R_n}{X_n} * \cos \varphi) \quad (3)$$

$$\begin{cases} \Delta U_p = \frac{\sqrt{3}}{3} I_{np} * R_n \\ \Delta U_q = \frac{\sqrt{3}}{3} I_{nq} * X_n \end{cases} \quad (4)$$

$$\begin{cases} I_{np} = I_n \cos \varphi \\ I_{nq} = I_n \sin \varphi \end{cases} \quad (5)$$

$$\frac{\Delta U_p}{\Delta U_q} = \frac{I_{np}}{I_{nq}} * \frac{R_n}{X_n} = \frac{R_n}{X_n} * (\tan \varphi)^{-1} \quad (6)$$

IV. Backgrounds for active power compensation

The general scheme of power systems interconnected with EAF and FACTS/ESS can be expressed as shown in Fig. 7. The operation of the EAF can cause not only the

fluctuation of the voltage and angle of the PCC bus, but also cause the fluctuation of generator angle, generator active and reactive power output in the nearby power system. The fluctuation of generator angles will cause the fluctuation of active and reactive power output of every generator. The power flow of the power system can change according to this fluctuation, meaning the power distribution of the entire system will change. That may create serious stability problems in the bulk power system, especially to the critical bus and generators. That is very harmful to the generator shaft as well.

Following is an analysis on the above phenomena. The generator stator voltage equation is as follows:

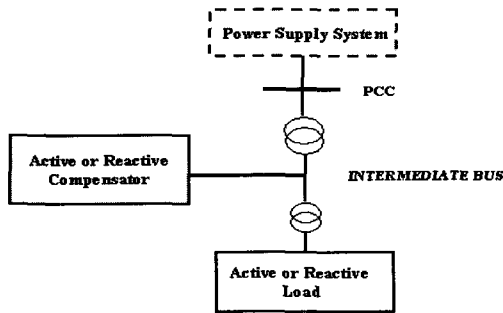

Fig. 7. General scheme of power systems

$$\begin{cases} u_a = p\psi_a - r_a i_a \\ u_b = p\psi_b - r_a i_b \\ u_c = p\psi_c - r_a i_c \end{cases} \quad (7)$$

where, $p=d/dt$, r_a is the coil resistance of each phase.

The rotor voltage equation of generator is being as follows:

$$\begin{cases} u_f = p\psi_f + r_f i_f \\ u_D = p\psi_D + r_D i_D \equiv 0 \\ u_Q = p\psi_Q + r_Q i_Q \equiv 0 \end{cases} \quad (8)$$

where, r_f , r_D and r_Q is the resistance of the f, D and Q coil, respectively.

Combining equations (7) and (8), the following vector equation is obtained:

$$\mathbf{u} = \mathbf{p}\boldsymbol{\psi} + \mathbf{r} \bullet \mathbf{i} \quad (9)$$

where,

$$\mathbf{u} = (u_a, u_b, u_c, u_f, u_D, u_Q)^T$$

$$\boldsymbol{\psi} = (\psi_a, \psi_b, \psi_c, \psi_f, \psi_D, \psi_Q)^T$$

$$\mathbf{r} = \text{diag}(r_a, r_a, r_a, r_f, r_D, r_Q)$$

$$\mathbf{i} = (-i_a, -i_b, -i_c, i_f, i_D, i_Q)^T$$

The instant output active power of generator is as follows:

$$P_e = u_a i_a + u_b i_b + u_c i_c \quad (10)$$

The magnetic-electric torque is as follows:

$$\begin{aligned} T_e &= p_p \frac{1}{\sqrt{3}} [\psi_a (i_b - i_c) + \psi_b (i_c - i_a) + \psi_c (i_a - i_b)] \\ &= p_p \frac{1}{\sqrt{3}} \boldsymbol{\Psi}_{abc}^T \begin{bmatrix} 0 & 1 & -1 \\ -1 & 0 & 1 \\ 1 & -1 & 0 \end{bmatrix} \mathbf{i}_{abc} \end{aligned} \quad (11)$$

where, p_p is the pole pairs of generator.

The generator rotor motion equation is as follows:

$$\begin{cases} J \frac{d^2 \theta_m}{dt^2} = M_m - M_e \\ \frac{d\theta_m}{dt} = \omega_m \end{cases} \quad (12)$$

As we know, the operation of the periodic active and reactive load can cause not only the voltage and angle fluctuation of the PCC bus, but can also cause the voltage and angle fluctuation on other feeders connected to the PCC bus, including the feeders of generators in the

nearly power system. From equation (7), (8) and (9) we know that the voltage U_{abc} change can cause the change of current i_{abc} . The fluctuation of U_{abc} and i_{abc} will bring the generator output active power fluctuation according to equation (10). The i_{abc} change will cause the change of T_e with the same trend. Because the input mechanical power (or torque) of the generator cannot change within such a short period of time, the swing of T_e finally causes the generator angle fluctuation with the same frequency.

In a multi-machine system, the active and reactive output powers of generators are as shown in equation (13).

$$\begin{cases} P_{ei} = E_i^2 G_{ii} + \sum_{j=1, j \neq i}^n (E_i E_j B_{ij} \sin \delta_{ij} + E_i E_j G_{ij} \cos \delta_{ij}) \\ Q_{ei} = -E_i^2 B_{ii} + \sum_{j=1, j \neq i}^n (E_i E_j G_{ij} \sin \delta_{ij} - E_i E_j B_{ij} \cos \delta_{ij}) \end{cases} \quad (13)$$

V. Simulation and Analysis

A. Impacts of Active Load Fluctuation

In this study, the Eastern U.S. system that contains the major portion of the NERC (North American Electric Reliability Council) is used. It is comprehensive system containing high-level 765kV transmission circuits and lower voltage distribution circuits. There are about 2,313 generators and 10,808 buses in the system. The capacity of the entire system is about 60.8GVA, containing 59.2GW active generation and 13.7GVAR reactive generation. The load of the system is about 58.5GW active load and 20.4GVAR reactive load. In additions, the EAF with the periodic load characteristics as shown in Fig.1 is located in the substation. The substation belongs to HOEGANAES Corp in Tennessee Valley Authority (TVA) system in Fig. 8. Nearby, there is a steam station containing 4 generator units at Gallatin in Tennessee.

Fig. 9 shows the voltage magnitude fluctuation at the PCC bus by the periodic active load or reactive load of the EAF. The voltage drop by the 30MVAR reactive load

is more than about 3 times of that caused by 30MW active load. Fig. 10 shows the PCC bus angle fluctuation by the EAF. The 30MW active load brings much larger bus angle fluctuation than that by 30MVAR reactive load. The bus angle fluctuation caused by active load has the opposite phase of that caused by the reactive load. For the generators in the nearby system, the generator angle oscillates according to the pulsing active load and reactive load. Fig. 11 shows that the angle oscillation of the Unit 4 generator caused by 30MW active load is larger than that by the same amount of reactive load. The angle oscillation caused by the EAF also show the opposite phase phenomenon as that in Fig. 10. In addition, Fig.12 shows that 30MW active load can cause more Unit 4 generator output active power fluctuation than that by the 30MVAR reactive load. On the contrary, the 30MVAR reactive load causes more generator reactive power output oscillation than that by the same value of active load as shown in Fig. 13. It should be noted that Unit1, Unit2 and Unit3 exhibit the same active power, reactive power, and angle fluctuation characteristics as that of Unit4.

From Fig. 9 to Fig. 13, we can see that the impact of active load and reactive load on the power quality is quite different. Thus the compensation methods for the power quality problems caused by different kinds load should be different. We can also recognize that the active load can cause severe power quality problems associated with angle and active power flow and the reactive load can bring more severe problems associated with voltage and reactive power flow

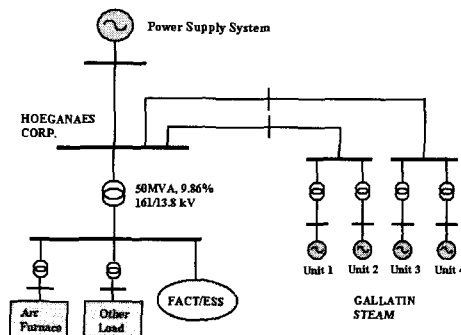

Fig. 8. Configuration of the practical power system

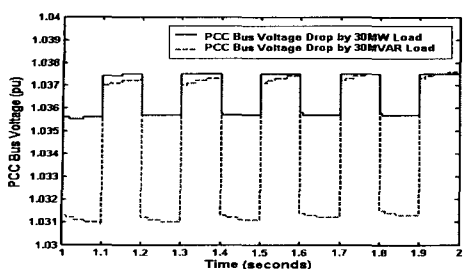

Fig. 9. Voltage drop at PCC bus caused by EAF

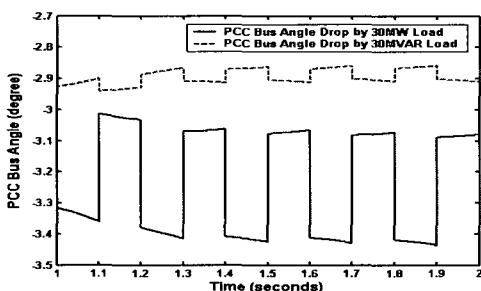

Fig. 10. PCC bus angle oscillation caused by EAF

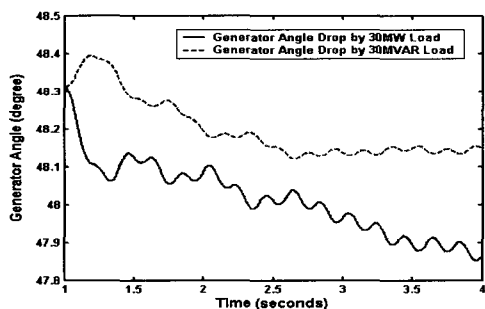

Fig. 11. Generator angle dynamics caused by EAF

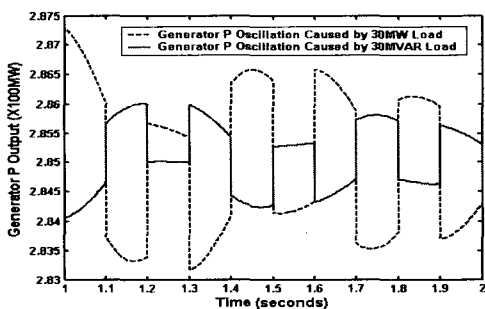

Fig. 12. Generator active power output oscillation caused by EAF

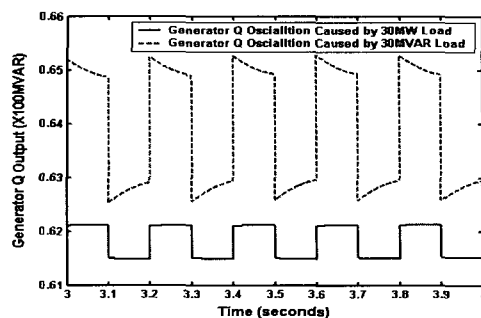

Fig. 13. Generator reactive power output oscillation caused by EAF

B. Active Power Compensation

This paper adapts FACT/ESS as the compensator of the active power as shown in Fig. 14. The 30MW active power is controlled by the FACT/ESS when the 30MW active load or the 30MVAR reactive load according to the operation of EAF is absorbed from power system.

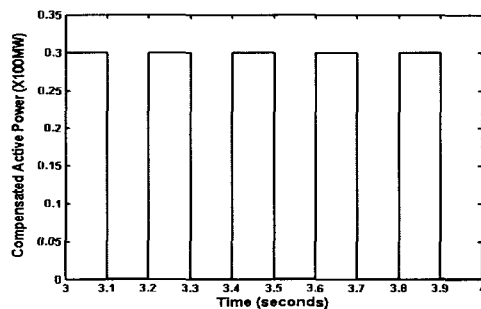

Fig. 14. Active power output (30MW) of FACT/ESS

Fig. 15 shows that the 30MW active power of FACT/ESS can completely mitigate the voltage flicker by the 30MW active load fluctuation of EAF. But the 30MW active power cannot mitigate the voltage fluctuation caused by 30MVAR reactive load thoroughly because of the X/R ratio issue. Fig. 16 is the effect of bus angle control by the active power compensation. There is no bus angle oscillation caused by the 30MW active load after compensation. According to the opposite of the phase phenomenon shown in Fig. 10, the bus angle caused by 30MVAR reactive load increases even after the compensation. The 30MW active power compensation

stimulates the bus angle oscillation on the contrary. In practice, the change of active and reactive loads of EAF is not as sharp as shown in this paper. They have the slope of the active and reactive power in the rising time. Therefore the spikes in figures of simulation results (Fig. 16 through Fig. 19) will not be so high.

In additions, Fig. 18 shows that the active power compensation by the FACT/ESS increases the angle oscillation of generator in the vicinity of the EAF by comparison with Fig. 11. The reason is also the opposite of the phase phenomenon shown in Fig. 10. The 30MW active power compensation is also an extra load for this generator when the 30MVAR reactive load is on. In spite of the angle oscillation improvement in Fig. 16 and Fig. 17, generator output active power oscillates more than that before compensation for the 30MVAR reactive load case as shown in Fig. 18. By comparing with the value in Fig. 12, the generator reactive power oscillation in Fig. 19 is smaller after the compensation for the 30MVAR reactive load case because the voltage fluctuation can be reduced as shown in Fig. 15.

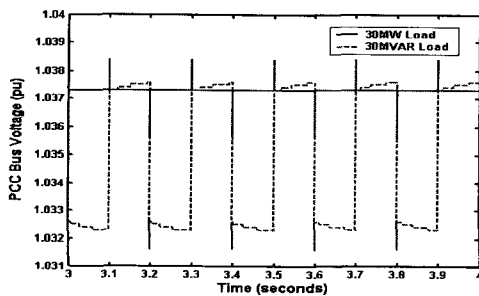

Fig. 15. PCC bus voltage compensated by FACT/ESS

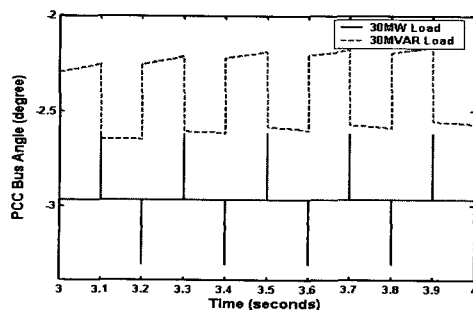

Fig. 16. PCC bus angle compensated by FACT/ESS

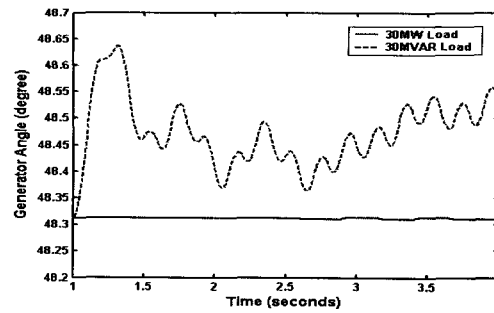

Fig. 17. Generator angle compensated by FACT/ESS

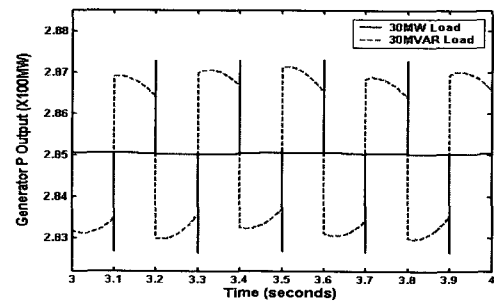

Fig. 18. Generator P output compensated by FACT/ESS

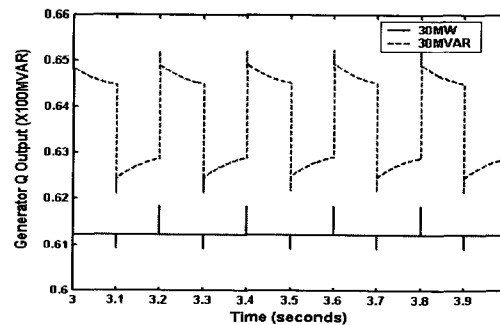

Fig. 19. Generator Q output compensated by FACT/ESS

The results above mentioned show that the active power compensation can solve the power quality problems caused by active load fluctuation in a perfect manner. Both the voltage drop and the angle fluctuation can be compensated thoroughly. But if active power compensation is applied to solve the power quality problems caused by reactive load, things are quite different. The active power compensation can mitigate the voltage flicker induced by reactive load, but the amount of compensated active power should be several times

(proportional to the X/R ratio) of the amount of reactive load to mitigate the voltage drop completely. The nearby generator reactive power output oscillation can be reduced because of the voltage control effects. For the reactive load, the voltage flicker mitigation control by active power compensation will increase the bus angle oscillation, thus increase the nearby generator angle oscillation and generator output active power oscillation. According to the results, it is verified that FACTS/ESS with the active and reactive power control capability provides significant improvements in mitigating power quality problems compared with the conventional methods.

VI. Conclusions

In this paper, the authors have discussed the powerful means for power quality problems based on the active power compensation using the FACTS/ESS. By applying them to practical power system, their effectiveness was illustrated and demonstrated as follows.

- (1) A practical arc furnace model to solve the power quality problems caused by EAF is presented. The EAF model contains a resistor and a reactor in a random operation mode to display the dynamic characteristics of EAF.
- (2) It is verified that the impact of active load and reactive load on the power quality is quite different. The active load can cause severe power quality problems associated with angle and active power flow and the reactive load can bring more severe problems associated with voltage and reactive power flow.
- (3) It is commonly accepted that the X/R ratio values of typical methods, considering only the upper transformer and transmission line, are very large enough to ignore the voltage drop caused by the active power. However, the X/R values by the proposed method are much less than the value

known to be typical. It is clear that we need to pay attention to the role of active power compensation when we study the voltage flicker caused by EAF.

- (4) The typical methods using only the reactive power compensation method have their own limitation in solving the power quality problems caused by active load variations. The coordination of both active power compensation and reactive power compensation is an ideal method to solve the power quality problems.
- (5) The FACTS/ESS with the active and reactive power control capability can provide significant improvements in mitigating power quality problems by the EAF in comparison with the conventional compensation methods such as SVC and STATCOM.

From the utility's point of view, one of the most important factors is the capital cost of the FACTS/ESS and its operating cost. The price of the compensating system is primarily influenced by the voltage level, power level, technology used and compensator topology. The economic analysis of the system could be a future research task.

References

- [1] Aurelio Garcia-Gerrada, Pablo Garcia-Gonzalez, Rafael Collantes, "Comparison of Thyristor-Controlled Reactors and Voltage-Source Inverters for Compensation of Flicker Caused by Arc Furnaces," *IEEE Trans Power Delivery*, Vol. 15, pp. 1225-1231, October 2000.
- [2] R. Grunbaum, "SVC Light: A Powerful Means for Dynamic Voltage and Power Quality Control in Industry and Distribution", *Power Electronics and Variable Speed Drives*, pp. 404-409, 18-19 September 2000, Eighth International Conference Publication No.475 @ IEE 2000.
- [3] Kuno Janson and Jaan Jarvik, "AC-DC Converter With Parametric Reactive Power Compensation," *IEEE Trans on Industrial Electronics*, Vol. 46, No.3, pp. 554-562, June 1999.
- [4] Z. Yang, C. Shen, L. Zhang, M. L. Crow and S.

- Atcitty, "Integration of a StatCom and Battery Energy Storage," *IEEE Trans Power System*, Vol. 16, pp. 254-260, May 2001.
- [5] Paulo. F. Ribeiro, Aysen Arsoy and Yilu Liu, "Transmission Power Quality Benefits Realized by a SMES-FACTS Controller," *Harmonics and Quality of Power*, 2000 Proceedings, pp. 307-312, Ninth International Conference, October 2000.
- [6] D. Stade, H. Schau, St. Prinz, "Influence of the Current Control Loops of DC Arc Furnaces on Voltage Fluctuations and Harmonics in the HV Power Supply System", pp. 821-825.
- [7] Tongxin Zhang, Elham B. Makram, "An Adaptive Arc Furnace Model," *IEEE Trans. Power Delivery*, Vol. 15, pp. 931-939, July 2000.
- [8] Rafael Collantes-Bellido, Tomas Gomez, "Identification and Modeling of a Three Phase Arc Furnace for Voltage Disturbance Simulation," *IEEE Trans Power Delivery*, Vol. 12, pp. 1812-1817, October 1997.
- [9] Omer Ozgun and Ali Bur, " Development of an Arc Furnace Model for Power Quality Studies," *Power Engineering Society Summer Meeting, 1999 IEEE*, pp.507-511, July 1999.
- [10] M.Parniani, H. Mokhtari, M. Hejri, "Effects of Dynamic Reactive Compensation in Arc Furnace Operation Characteristics and Its Economic Benefits," *IEEE Conference 2002*, pp. 1044-1049, July 2002.
- [11] V. Karasik, K. Dixon, C. Weber, B. Batchelder, G. Campbell, and Ribeiro, "SMES for Power Utility Applications: A Review of Technical and Cost Considerations," *IEEE Trans. Applied Superconductivity*, Vol.9, No.2, June 1999.

Jae-Eon Kim

[Regular Member]

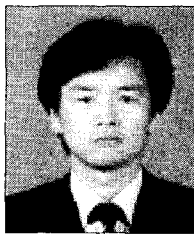

- 1982. 2 : Electrical Eng, Hanyang Univ.(B.S.)
- 1984. 2 : Electrical Eng, Hanyang Univ.(M.S.)
- 1996. 3 : Electrical Eng, Kyoto Univ.(Ph.d)
- 1984. 3 ~ 1998. 8 : Senior Researcher, KERI

- 1998. 9 ~ now : Associate Professor, Chungbuk Univ.

<Major>

Power System, Distribution System, Dispersed Power Sources, Power Quality

Dae-Seok Rho

[Regular Member]



- 1985. 2 : Electrical Eng, Korea Univ.(B.S.)
- 1987. 2 : Electrical Eng, Korea Univ.(M.S.)
- 1997. 3 : Electrical Eng, Hokkaido Univ.(Ph.d)
- 1987. 3 ~ 1998. 7 : Senior Researcher, KERI

- 1999. 2 ~ now : Associate Professor, Korea University of Technology

<Major>

Distribution Power System, Dispersed Power Sources, Power Quality