

Experimental Study on the Characteristics of Air Heating Vaporizer at Different Season

계절 변화에 대한 공기 가열식 기화기의 특성에 관한 실험적 연구

엘드윈 자디위나타 · 이용훈 · 정한식 · 정효민

D. Eldwin, Y. H. Lee, H. S. Chung and H. M. Jeong

Key Words : LNG, LN₂, Vaporizer, Super Low Temperature, Fin

요약 : 현재, 육지에서 필요한 천연 가스 (NG)의 연기 위한 방법으로 공기 가열식 기화기의 사용이 증가하고 있다. 특히, 파이프라인에 의해 도달될 수 없는 거리가 멀리 떨어진 소외된 지역까지 보낼 수 있기 때문에 소형 위성기지의 역할은 대단히 중요하다고 할 수 있다. 소형 위성기지의 LNG는 인수기지에서 탱크로리를 이용하여 배달되고 그 후에 위성기지에서 기화과정을 통하여 각 수요처로 보내어진다. 공기 가열식 기화기는 LNG 인수기지 외의 소형 위성기지 단위에서 최근 많이 개발되고 사용되고 있는 기화기의 종류 중 하나라고 할 수 있다¹⁾. 효율적인 공기 가열식 기화기를 개발하기 위하여, 편이 없는 경우와 편이 8개이고 편의 길이가 55 mm인 공기 가열식 기화기를 사용하여 실험을 진행하였고 그리고 나서 두 가지 유형의 기화기를 비교하였다. 실험조건은 기화기의 길이 변화와 여러 가지 주위 조건(온도, 습도, 풍속)을 변화하였다. 실험에 적용된 주위 온도는 각 계절별 온도와 동일한 온도를 적용하였다. 본 실험에서 나타내고자 한 공기가열식 기화기의 주요 특성은 각 계절별 조건에 따른 입구 측과 출구 측의 온도차를 비교하는 것이다. 액화천연가스(LNG)를 가지고 실험을 하는 것은 위험성이 있어 특성이 비슷하면서 안전한 LN₂를 사용하여 실험을 진행하여 편을 가지는 기화기가 편이 없는 기화기보다는 좋다는 결과를 확인할 수 있었다.

Nomenclature

- ΔT : temperature difference (inlet-outlet temperature difference) [K]
- C_p : specific heat at const. pressure [kJ/kg^oC]
- h_o : average convection coefficient [W/m².K]
- \dot{m} : mass flow rate [kg/s]
- \dot{Q} : heat transfer rate [W]
- $T_{m,os}$: tube outer surface mean temperature [K]
- T_{∞} : room or ambient temperature [K]
- $T_{m,m}$: tube inlet mean temperature [K]
- $T_{m,out}$: tube outlet mean temperature [K]
- A_{os} : tube outer surface area [K]

1. INTRODUCTION

Liquefied natural gas (LNG) is natural gas (NG)that has been cooled to the point that it condenses to a liquid, which occurs at a temperature of approximately -256 °F (-161 °C) and at atmospheric pressure. Liquefaction reduces the volume by approximately 600 times thus making it more economical to transport between continents in specially designed ocean vessels, whereas traditional pipeline transportation systems would be less economically attractive and could be technically or politically infeasible. Thus, LNG technology makes natural gas available throughout the world. LNG generally contains more than 90 % methane (CH₄). It also contains small amount of ethane, propane, butane and some heavier alkanes. But, it could be also designed to be almost 100% methane. Natural gas liquefaction dates back to the 19th century when British chemist and physicist Michael Faraday experimented with liquefying

접수일 : 2006년 1월 10일, 채택확정 : 2007년 4월 16일
정한식(책임저자) : 경상대학교 기계항공공학부, 해양산업연구소

E-mail : hschung@gnu.ac.kr, TEL : (055)640-3185
Eldwin, 이용훈 : 경상대학교 대학원 정밀기계공학과
정효민 : 경상대학교 기계항공공학부, 해양산업연구소

different types of gases, including natural gas. German engineer Karl Von Linde built the first practical compressor refrigeration machine in Munich in 1873. The first LNG plant was built in West Virginia in 1912. It began operation in 1917. The first commercial liquefaction plant was built in Cleveland, Ohio, in 1941. The LNG was stored in tanks at atmospheric pressure. The liquefaction of natural gas raised the possibility of its transportation to distant destinations.

Natural gas is used in homes for cooking and heating, in public institutions, in agriculture, by industry and to generate electric power. Natural gas is important not only as a clean source of energy, but also as a feedstock for the petrochemical industry to produce plastics, fibers, fertilizers, and many other products.

At present time, LNG demand of world increases. This could be seen in the Fig. 1. Consequently, the need for continuous improvement of LNG-related equipments also increases.

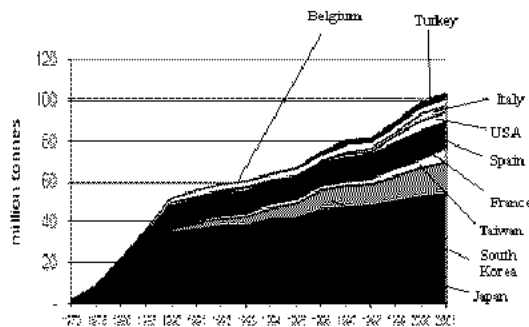

Fig. 1 Growth in LNG demands²⁾

To return LNG to a gaseous state, it is fed into a regasification plant. On arrival at the receiving terminal in its liquid state, LNG is pumped first to a double-walled storage tank, similar to those used in the liquefaction plant, at atmospheric pressure, then pumped at high pressure through various terminal components. The LNG is warmed by passing it through pipes heated by direct-fired heaters, seawater or through pipes that are in heated water. These equipments are known as 'Vaporizer'. The vaporized gas is then regulated for pressure and enters the pipeline system as

natural gas. Finally, residential and commercial consumers receive natural gas for daily use from local gas utilities or in the form of electricity.

But for inland area, where pipelines do not exist or difficult to construct, the LNG is delivered to the inland-receiving terminal available at that area, regasified and delivered to consumers. At inland-receiving terminal, air heating vaporizer type is usually used. It is because of the construction and running costs of this type of vaporizer are low. Besides that, it has the simplest operation system. The constraint of this type of vaporizer is the small to medium production capacity due to the small heat capacity of air as its heat sources, Sugano, 2006³⁾. Therefore, to meet the NG increasing-demand at inland area (where pipelines do not exist or difficult to construct), research for developing the best performance of air heating vaporizer should be conducted. Experiment of finless type and finned type of 4 fin 80 mm length and 8 fin 55 mm length had been conducted at constant room temperature by Lee et al, 2006⁴⁾.

Now, the study in this paper also tries to contribute in finding characteristics of air heating vaporizer at different seasons that could be used for next research in designing high-performance air heating vaporizer.

2. HEAT TRANSFER BASIC THEORY

From Newton's law of cooling we know that average convection coefficient is proportional to the convection heat transfer rate. Hence:

$$\dot{Q} = hA_{os}(T_{\infty} - T_{m,os}); \text{ if } T_{m,os} < T_{\infty} \quad (1)$$

And, because the flow in a tube (and a vaporizer is actually a long tube) is completely enclosed, an energy balance may be applied to determine the convection heat transfer rate in terms of the difference in temperatures at the tube inlet and outlet. If the flow rate is constant and assuming that fluid kinetic and potential

energy changes are negligible, there is no shaft work and regarding C_p as constant, the energy rate balance equation is

$$\dot{Q} = \dot{m} C_p (T_{m,out} - T_{m,in}) \quad (2)$$

From equation (1) and (2) we get

$$\dot{m} C_p (T_{m,out} - T_{m,in}) = h_o A_{os} (T_\infty - T_{m,os}) \quad (3)$$

These equation show us that, if the mass rate constant, the increase of ambient or room temperature (T_∞) will also increase the heat transfer rate which will also increase the tube outlet temperature ($T_{m, out}$). On the other word, the room temperature is proportional to the inlet-outlet tube temperature difference T .

3. EXPERIMENTAL SETUP

The experimental setup (Fig. 2) consists of four parts. Those are:

- (1) Test Room
- (2) Room conditioning unit
- (3) Data acquisition unit
- (4) Electronic control unit

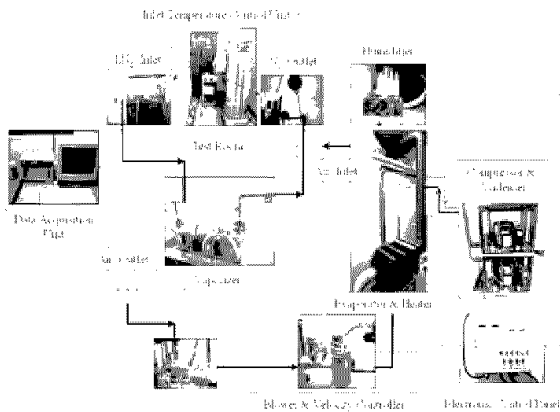

Fig. 2 Schematic diagram of experimental setup for vaporizer system

The vaporizer is located in a room which size is 1.99m × 1.34m × 2.9m. This room is called test room. The condition of the test room is maintained using room conditioning unit so that it has the

same condition with the season average condition available in Tong young City, South-Korea. This data was taken from the government⁵⁾. Liquid nitrogen (LN_2) is used instead of LNG in this experiment for safety reason.

The vaporizers are made of aluminum alloy. Thermocouples are installed on the vaporizer every 500mm to measure the temperature of the Nitrogen inside the vaporizer. All of these temperature data were recorded using data logger. The type of the thermocouple used is K-Type.

The experiment was conducted at four different conditions for each length. Those conditions were spring, summer, autumn and winter condition. The types of vaporizer used in the experiment were finless type (Fig. 3-4) and finned type with 8 fins and 55mm fin length (Fig. 5-6). The notation for the finned type is 8fin55le. Note that the fins protrude 50mm outward from the outer surface of the pipe and 2mm inward from the inner surface of the pipe. Thickness of the pipe is 3mm. The lengths tested for each type of vaporizer were 4000mm, 6000mm and 8000mm. The condition of each season is stated below.

Season conditions :

- ▶ Spring: temp 285 K, RH 65%, air velocity 2.5 m/s
- ▶ Summer: temp 303 K, RH 80%, air velocity 2 m/s
- ▶ Autumn: temp 290 K, RH 70%, air velocity 2.5 m/s
- ▶ Winter: temp 273 K, RH 55%, air velocity 3 m/s

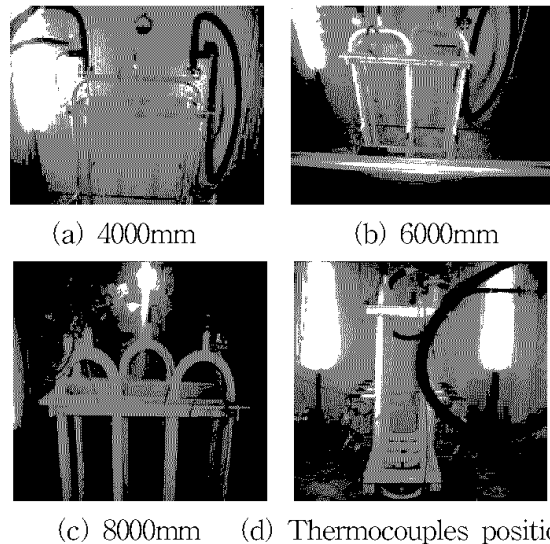

Fig. 3 Picture of the test vaporizer of finless type and the position of thermocouples

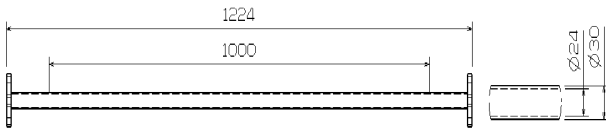

Fig. 4 Basic pipe shape of the finless type used

The room conditioning unit consisted of dehumidifier, heater, refrigerator and humidifier. The electronic control unit controlled the operation of these room conditioning equipments so that the equipments will operate automatically when needed. If the temperature of the test room was higher than the set-temperature, the refrigerator will operate and the heater will stop. If the opposite condition happened, the heater will operate and the refrigerator will stop. The humidifier and dehumidifier would also operate reversely one to another; depends on the humidity of the test room.

In this experiment the pressure was maintained constant, 2 bar absolute pressure, using pressure regulator. The flow rate was 0.4-0.45kg/min. The flow rate was measured by dividing the change of the LN₂ tank weight with the time duration of the experiment. The experiment was held in 60 minutes and the data was taken every 6 seconds by means of data acquisition system.

The inner diameter of the vaporizer tube was 24 mm and the outer diameter was 30 mm. The inlet temperature was constant at -173.2 °C (100.2 K).

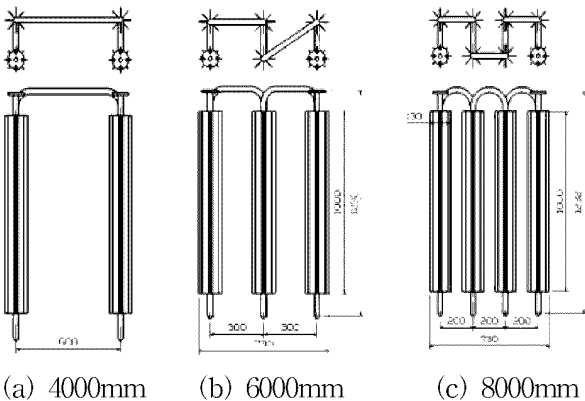

Fig. 5 Drawing of the test vaporizer of finned type 8fin55le vaporizer

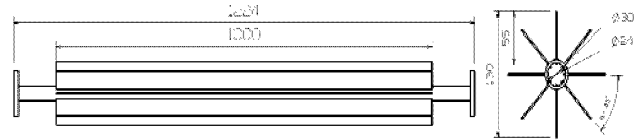
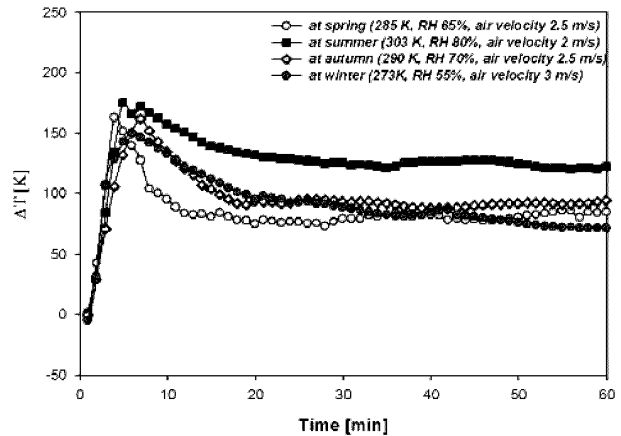

Fig. 6 Basic pipe shape of the finned type 8fin55le used

4. RESULTS AND DISCUSSIONS

In this study, the heat transfer rate will be represented by the temperature difference between LN₂ outlet and inlet. The specific heat (C_p) assumed to be constant. For temperature range of 100-303 K, its C_p is 1108.2-1042.9 J/kgK. This assumption is based on the data taken from NIST on-line Thermo physical Properties of Fluid System⁶⁾.



(a) finless type 4000mm vaporizer

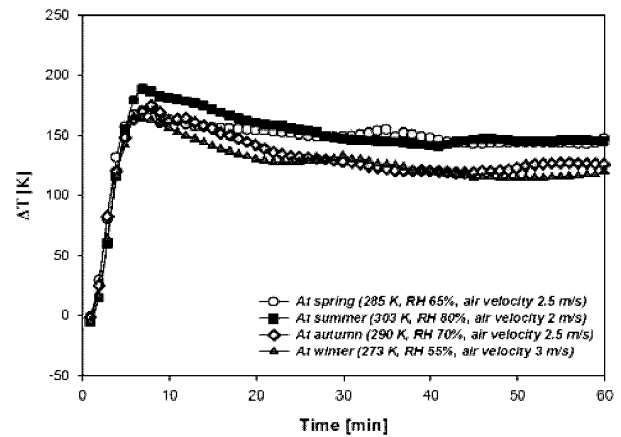

(b) finless type 6000mm vaporizer

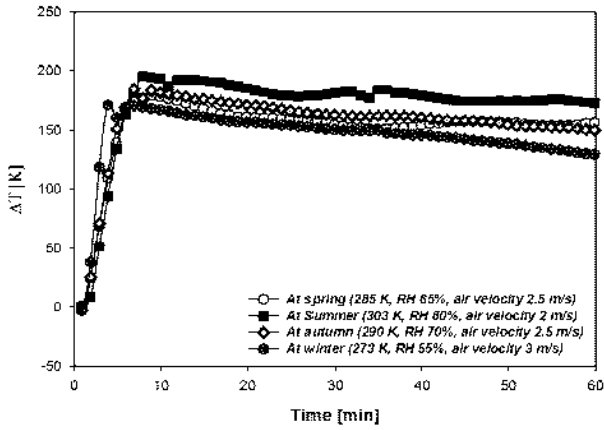

(c) finless type 8000mm vaporizer

Fig. 7 Temperature differences related to time for finless type vaporizers at different seasons

From the graph Time Vs Temperature difference at different season for finless type, 4000 and 6000mm (Fig. 7a - b), it can be seen that the nearly steady condition was reached after 20 minutes. But actually they experienced slight decrease.

For finless 8000mm vaporizer (Fig. 7c), winter condition the graph tends to decrease more severely compared to the others. These phenomena (the decrease of temperature difference according to time at finless type 4000, 6000 and 8000mm) are because of the ice deposits formed on the vaporizer.

Nevertheless, it is generalized that their steady condition occurred after 20 minutes. Therefore, the average temperature difference data is taken from 20 minute until 60 minute of the experiment.

For the finned type 8fin55le vaporizers (Fig. 8a-c), it can be concluded that the steady condition happened at approximately after 10 minutes. Hence, data from 10 until 60 minutes of the experiment will be used to calculate the average temperature difference. On the 8fin55le vaporizers, the temperature differences during the experiment were steadier at all lengths and conditions compared to the finless type (comparing Fig. 7 and Fig. 8). Here, ice deposits formed as it also occurred in finless type. But, different from the finless type, its T are steadier as stated before.

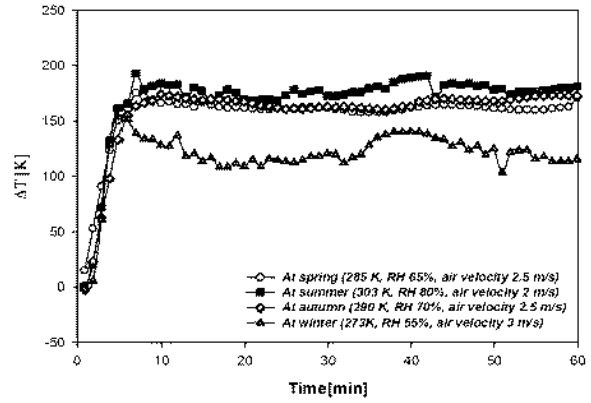

(a) 8fin55le 4000mm vaporizer

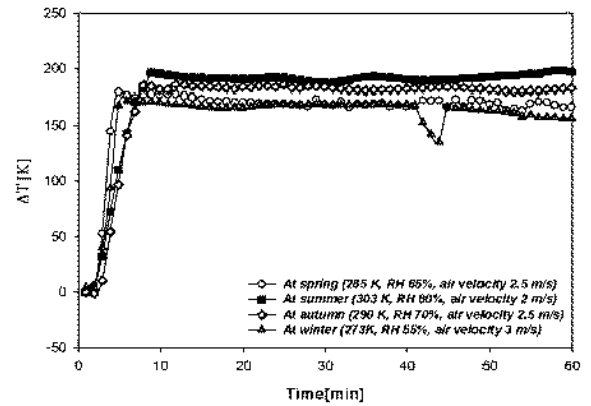

(b) 8fin55le 6000 mm vaporizer

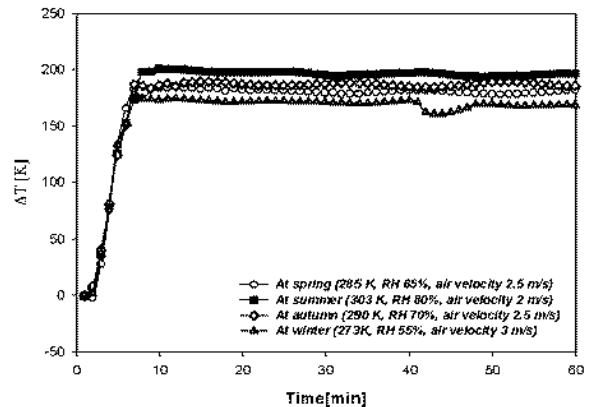

(c) 8fin55le 8000 mm vaporizer

Fig. 8 Temperature differences related to time for finned type 8fin55le vaporizers at different seasons

From these phenomena, therefore, it can be concluded that on the finned type 8fin55le vaporizers, the influence of ice deposits to the heat transfer rate is lower than in the finless type. This is because of the heat transfer area of the finned type is wider so that the ice deposits need more time to cover all of the surface.

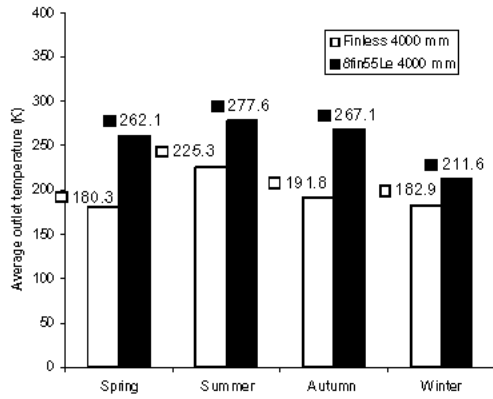

(a) 4000mm vaporizer

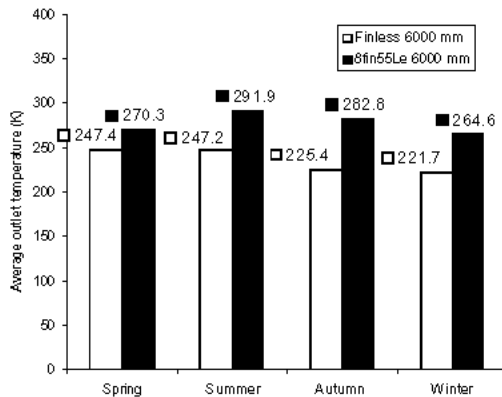

(b) 6000mm vaporizer

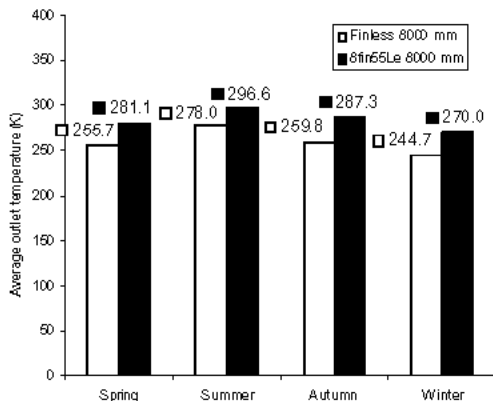

(c) 8000mm vaporizer

Fig. 9 Comparison of average outlet temperature between finless type and 8fin55le type vaporizers for different lengths at different seasons

Furthermore, from the experimental results, it is obviously seen that the T , which represent the heat transfer rate, on finned type 8fin55le vaporizers are much higher than the finless type (Fig. 9a-c). The fins on the finned type vaporizers increase the heat transfer area which also increases the heat transfer rate as known in the heat transfer basic theory.

The performance based on ambient temperature is presented on Table 1 and 2. It is defined as:

$$Performance = (T_{m,out}/T_{\infty}) \times 100\% \quad (4)$$

It is clear now that the finned type 8fin55le vaporizers have better heat transfer rate compared to the finless type. Now, the optimum vaporizer length among the 8fin55le vaporizers should be taken.

They will be evaluated based on the outlet temperature and the length. The shortest length which can achieve outlet temperature of 273K will be chosen. The temperature 273K is taken as the reference because, on that point, the water vapor contained in the ambient air will not freeze on the outer surface of the delivery pipe or the natural-gas storage tank.

Table 1 Performance of finless type vaporizer based on ambient temperature

Length	Performance of vaporizer (%)			
	Spring (285 K)	Summer (303 K)	Autumn (290 K)	Winter (273 K)
4000mm	63.3	74.4	66.1	67.0
6000mm	86.8	81.6	77.7	81.2
8000mm	89.7	91.7	89.6	89.6

Table 2 Performance of 8fin55le type vaporizer based on ambient temperature

Length	Performance of vaporizer (%)			
	Spring (285 K)	Summer (303 K)	Autumn (290 K)	Winter (273 K)
4000mm	92.0	91.6	92.1	77.5
6000mm	94.8	96.3	97.5	96.9
8000mm	98.6	97.9	99.1	98.9

Table 3 Average outlet temperature of finned type 8fin55le vaporizer for each length and condition

Length	Average outlet temperature (K)			
	Spring (285 K)	Summer (303 K)	Autumn (290 K)	Winter (273 K)
4000mm	262.1	277.6	267.1	211.6
6000mm	270.3	291.9	282.8	264.6
8000mm	281.1	296.6	287.3	270.0

Based the bolded-italic-underlined values in Table 3, the chosen 8fin55le types are the 8000 mm, 4000 mm and 6000 mm length for spring, summer and autumn conditions respectively. At winter condition, the outlet temperature must be below 273 K because the ambient temperature is 273 K. However, as an approximation, the 8000 mm is chosen for the winter condition.

Finally, we can conclude that to accommodate the condition at all seasons, the 8000mm length of 8fin55le type is chosen as it can fulfill the requirement to reach the minimum outlet temperature of 273 K (except for winter season as mentioned before).

5. CONCLUSIONS

The information from this study can be summarized as follow:

1. The heat transfer rate on finned type 8fin55le vaporizers are better than the finless type because the finned type has wider heat transfer area due to the existence of the fin.
2. The heat transfer rate on finned type 8fin55le vaporizers are steadier than the finless type because of the influence of the ice deposits on the finned type decreases due to the wider heat transfer area. So, it needs more time for the ice deposits to cover whole surface of the vaporizer.
3. In deciding the optimum length of 8fin55le vaporizer, the shortest length which can achieve outlet temperature of 273 K will be chosen. The temperature 273 K is taken as the reference because, on that point, the water vapor contained in the ambient air will not freeze on the outer surface of the delivery pipe or the storage tank.
4. The optimum finned type 8fin55le vaporizers are the 8000 mm, 4000 mm and 6000 mm length for spring, summer and autumn conditions respectively. At winter condition, the outlet temperature must be below 273 K because the ambient temperature is 273 K.

However, as an approximation, the 8000 mm length is chosen as the optimum length at winter condition.

5. Finally, we can conclude that to accommodate the condition at all seasons, the 8000 mm length of 8fin55le type is chosen as it can fulfill the requirement to reach the minimum outlet temperature of 273 K (except for winter season as mentioned before).

ACKNOWLEDGEMENT

This research was supported by the Program for the Training of Graduate students in Regional Innovation which was conducted by the Ministry of Commerce Industry and Energy of the Korean Government and second-phase of BK21 project. The authors gratefully appreciate for the support.

REFERENCES

1. T. W. Kong, S. C. Lee, Y. H. Lee, H. S. Chung and H. M. Jeong, 2006, "A Study on The Air Vaporizer for Liquefied Natural Gas with Super Low Temperature", Proceedings of the 3rd Asian Conference on Refrigeration and Air-conditioning, May 21-23, 2006, Gyeongju, South Korea. pp. 853-856.
2. M. M. Foss, 2003, "Introduction to LNG, An Overview on Liquefied Natural Gas (LNG), its properties, the LNG Industry, Safety Considerations". Ph.D. The University of Texas at Austin, Chief Energy Economist and CEE Head, Energy Economics Research at the Bureau of Economic Geology.
3. K. Sugano, 2006, "LNG Vaporizers, Research and Development", Kobe Steel Engineering Reports, Vol. 56, No. 2.
4. Y. H. Lee, S. C. Lee, H. M. Jeong and H. S. Chung, 2006, "Experimental Study on Gasification Characteristic by Using Liquefied Gas Vaporizer with Various Shape", Proceedings of the 2nd International Conference on Cooling and Heating Technologies.

Dalian, China, July 26-30, pp. 203-208.

5. Korea Meteorological Administration official website (<http://www.kma.go.kr/intro.html>).
6. NIST on-line Thermophysical Properties of Fluid System (<http://webbook.nist.gov>).
7. M. J. Moran, H. N. Saphiro, B. R. Munson, D. P. DeWitt, 2003, John Wiley & Sons, Inc. "Introduction to Thermal Systems Engineering: Thermodynamics, Fluid Mechanics and Heat Transfer".