

Theoretical Analyses of Autothermal Reforming Methanol for Use in Fuel Cell

Hak-Min Wang, Kap-Seung Choi, Il-Hwan Kang

*Graduate School of Mechanical Engineering, INJE University,
607 Obang-Dong, Kimhae, Kyongnam 621-749, Korea*

Hyung-Man Kim*

*School of Mechanical and Automotive Engineering, INJE University,
607 Obang-Dong, Kimhae, Kyongnam 621-749, Korea*

Paul A. Erickson

*Department of Mechanical and Aerospace Engineering, UC Davis,
One Shields Avenue, Davis, California 95616, USA*

As fuel cells approach commercialization, hydrogen production becomes a critical step in the overall energy conversion pathway. Reforming is a process that produces a hydrogen-rich gas from hydrocarbon fuels. Hydrogen production via autothermal reforming (ATR) is particularly attractive for applications that demand a quick start-up and response time in a compact size. However, further research is required to optimize the performance of autothermal reformers and accurate models of reactor performance must be developed and validated. The design includes the requirement of accommodating a wide range of experimental set ups. Factors considered in the design of the reformer are capability to use multiple fuels, ability to vary stoichiometry, precise temperature and pressure control, implementation of enhancement methods, capability to implement variable catalyst positions and catalyst arrangement, ability to monitor and change reactant mixing, and proper implementation of data acquisition. A model of the system was first developed in order to calculate flowrates, heating, space velocity, and other important parameters needed to select the hardware that comprises the reformer. Predicted performance will be compared to actual data once the reformer construction is completed. This comparison will quantify the accuracy of the model and should point to areas where further model development is required. The end result will be a research tool that allows engineers to optimize hydrogen production via autothermal reformation.

Key Words : Autothermal Reforming (ATR), Methanol, Hydrogen Production, Fuel Cell

Nomenclature

ATR : Autothermal reforming

GHSV : Gas hourly space velocity

m : Number of hydrogen atoms in a fuel molecule

n : Number of carbon atoms in a fuel molecule

p : Number of oxygen atoms in a fuel molecule

PEM : Polymer electrolyte membrane

POX : Partial oxidation reforming

S/C : Steam to carbon molar ratio

SR : Steam reforming

V : Voltage

V : Watts

x : oxygen to fuel molar ratio

x₀ : oxygen to fuel molar ratio

* Corresponding Author,

E-mail : mechkhm@inje.ac.kr

TEL : +82-55-320-3666; FAX : +82-55-324-1723

School of Mechanical and Automotive Engineering,
INJE University, 607 Obang-Dong, Kimhae, Kyongnam
621-749, Korea. (Manuscript Received September 2,
2005; Revised March 23, 2006)

ΔH : Change in enthalpy

ΔH_r : Heat of reaction

1. Introduction

Current modes of transportation rely on fossil-fueled internal combustion engines that are Carnot cycle limited in their efficiency and can produce high emissions. In order to obtain higher efficiencies and reduce emissions, much attention has been given to the prospect of fuel cells, which operate on an electrochemical process. Of the many fuel cell types currently under development, polymer electrolyte membrane (PEM) fuel cells are the most heavily pursued for transportation applications. PEM fuel cells offer the highest power density and operate at low temperatures, which make them particularly attractive for integration into vehicles. PEM fuel cells require a high purity hydrogen gas (H_2) fuel stream for efficient and reliable operation.

Even though hydrogen is the most plentiful element on the planet, there is no natural source of hydrogen in its elemental form, besides trace amounts contained in natural gas reserves. Therefore, hydrogen must be produced from any of a variety of processes including: Reforming of hydrocarbon fuels, Electrolysis, Thermal decomposition of water, Thermal processing of biomass.

Though Fuel cell vehicles face the complex challenge of supplying hydrogen to the fuel cell. Hydrogen can be stored on board a vehicle in many forms including, liquid, compressed gas, or in more complex systems in hydrogen-rich chemicals. However, none of the methods of hydrogen storage are without significant problems and wherever possible hydrogen should not be stored at all (Larminie and Dicks, 2003). The two most significant problems with hydrogen storage include the lack of infrastructure and the low volumetric energy density of hydrogen. Currently, the vast majority of refueling stations and transport pipelines in the United States are based on liquid fuels such as gasoline and diesel. To implement a hydrogen infrastructure would require an expensive conversion of the existing refueling infra-

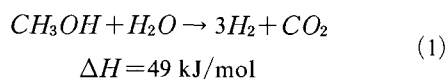
structure. This however does not preclude the distributed generation of hydrogen near the point of use, such as with on-board or on-site reforming devices. The most challenging problem, however, is the energy storage issue. Though hydrogen has a very high mass energy density, its volumetric energy density is extremely low as compared to conventional fuels.

Hydrogen should be made near the point of consumption and when it is needed (Larminie and Dicks, 2003). Reforming hydrocarbon fuels either off-board or on-board a vehicle may satisfy a fuel cell's hydrogen requirement. There are currently three main methods for reforming hydrocarbon fuels into hydrogen rich gas; steam reforming (SR), partial oxidation reforming (POX), and autothermal reforming (ATR). Each method will be discussed briefly in the following sections.

2. Theoretical Analyses

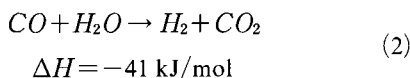
2.1 Steam reforming

Steam reforming is currently the most widely used method for producing hydrogen from natural gas in large scale industrial applications. In the endothermic steam reforming reaction, heat from an external source is consumed as the hydrocarbon fuel is mixed with steam and chemically reacted over a catalyst bed to produce hydrogen and carbon dioxide. Equation (1) shows the steam reforming chemical reaction for methanol which requires 49 kJ/mol of heat input.



Because of its endothermic nature, steam reformers typically require long start up and shut down times which are not appropriate for automotive applications or small scale refueling.

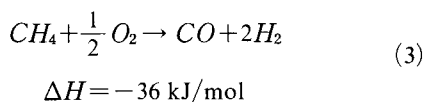
In real applications there are other products of the reforming reaction such as carbon monoxide, unreformed fuel and other impurities that may have been present in the reactants. Carbon monoxide is typically reacted with more steam to form carbon dioxide and more hydrogen through the water gas shift reaction as shown in Eq. (2).



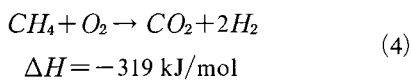
As the water gas shift reaction is exothermic, the reaction will shift towards the reactant side at high temperatures. In practice, the shift reaction is carried out in multiple stages with interstage cooling to prevent overheating. For further clean-up of carbon monoxide, some common methods used are pressure swing absorption, preferential oxidation, and membrane separation.

2.2 Partial oxidation

Partial oxidation is an alternative to steam reforming which is generally employed with higher hydrocarbons or if pure oxygen is available (Hoogers, 2003). This process sacrifices some efficiency relative to steam reforming but offers rapid dynamic response and compactness. Unfortunately this process is susceptible to coke formation due to the lack of water and therefore must be carried out at very high temperatures. Partial oxidation can be performed with or without a catalyst; using a catalyst allows for a lower reaction temperature. The partial oxidation of methane is described by the following chemical reaction Eq. (3).



If the oxygen to fuel ratio is increased, then the reaction becomes even more exothermic.



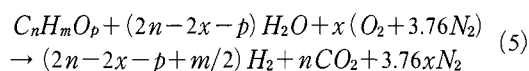
Equation (4) illustrates how the amount of heat generated from the partial oxidation can be quickly increased from -36 kJ/mol to -319 kJ/mol by simply increasing the amount of oxygen in the reaction, i.e. increasing the air flow rate, and combusting additional fuel. Therefore, it is possible to reduce reformer start up times by increasing air (or oxidant) flowrate.

2.3 Autothermal reforming

Autothermal reforming is essentially a combi-

nation between steam reforming and partial oxidation. This may be done by bringing the two reforming reactions into close thermal contact or by placing them into a single catalytic reactor. The latter is the most efficient means of heat transfer. Autothermal reforming has advantages of both steam reforming and partial oxidation in that it has potentially high efficiencies and adequate response to dynamic loads. Ideally, the heat generated from the exothermic partial oxidation reaction is used for rapid start up and supplying the heat needed for the endothermic steam reforming reaction during operation. Once the reactor is at operating temperature, the fuel, steam and air are all fed into the reactor in the same step. The reactants auto-ignite and react to form the ideal products of hydrogen and carbon dioxide.

Stoichiometry is a very important parameter in autothermal reforming. The two variables that are looked at most closely are the oxygen to fuel ratio (x), and the steam to carbon ratio (S/C). The general form of the autothermal reforming reaction of a hydrocarbon fuel, assuming complete conversion of the reactants is:



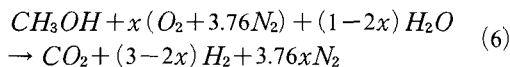
where $(2n - 2x - p)$ represents minimum amount of water required in the reaction, and x represents the oxygen to fuel ratio. The heat of reaction is dependant on x and S/C . Note that $(2n - 2x - p)$ is the minimum amount of water required for the reaction and the S/C ratio in practical applications is typically much higher in order to inhibit coke formation.

Autothermal reformation operates ideally at a thermo-neutral point, neither consuming nor releasing thermal energy. This gives autothermal reforming a higher efficiency and hydrogen concentration than partial oxidation while at the same time providing a better dynamic response than steam reforming. Hot spots are reduced because of the addition of steam in the reforming reaction. This thermal integration lowers the potential temperature rise that is caused by the oxidation of the fuel and thereby reduces the poten-

tial for catalyst sintering. Autothermal reforming has potential in applications that require a lightweight, compact reactor capable of reforming multiple fuels (Ahmed and Krumpelt, 2001). These criteria fit the needs of an automotive application or on-site generation for direct hydrogen fuel cell vehicles. Autothermal reforming can provide a rapid response to hydrogen demand at high efficiencies and should therefore be considered for generating hydrogen for fuel cell vehicles.

3. Modeling of Autothermal Reforming

A preliminary model of the ATR reactor was created in order to determine flow rates of reactants, space velocity, and heating requirements. To simplify the model for design purposes, it was assumed that the hydrocarbon fuel was methanol. Although most work is done on ATR with higher hydrocarbons, focusing on methanol provides a basic understanding of the process. It is also possible to reform a mixture of hydrocarbon fuels, much like conventional vehicles can utilize a mixture of gasoline and ethanol. Methanol is a very attractive fuel for hydrogen production. It is reformed at relatively low temperatures (250–400°C), can be produced renewably or from coal resources, and can be stored in liquid form. The autothermal reforming of methanol can be represented by the ideal reaction :



where the S/C is assumed to be the minimum amount of water required for the reaction and therefore becomes a function of the oxygen to fuel ratio $(1-2x)$. For most practical applications the S/C is much larger than this.

The heat of reaction indicates whether a reaction is exothermic (releasing energy) or endothermic (requiring energy) and is defined as the heat of formation of the products minus the heat of formation of the reactants ($\Delta H_r = \Delta H_{\text{products}} - \Delta H_{\text{reactants}}$). Since the heat of formation for the oxygen, nitrogen and hydrogen reactants and products in Eq. (6) are all zero, the heat of reaction

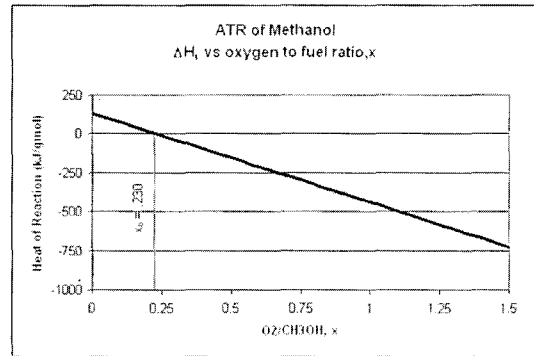


Fig. 1 Heat of reaction of ATR of methanol vs. oxygen to fuel ratio

for methanol autothermal reforming is simplified to :

$$\Delta H_r = \Delta H_{f,\text{CO}_2} - (1-2x)\Delta H_{f,\text{H}_2\text{O}(l)} - \Delta H_{f,\text{fuel}(l)} \quad (7)$$

By evaluating the heat of reaction as a function of the air to fuel ratio, x , it is possible to find x_o , the optimum air to fuel ratio which produces a net enthalpy change of zero. Plotting the heat of reaction for methanol as a function of x , from $x=0$ (steam reforming) to $x=1.5$ (complete combustion), and assuming that the conversion of the oxidant is 100%, yields Fig. 1 (Ahmed, 2001). The stoichiometry of the reaction is simply an oxygen to fuel ratio = x and $S/C=1-2x$, until $x>0.5$. At this point water is no longer consumed in the reaction, but rather produced as a product of combustion. It is easy to pinpoint the thermoneutral point ($\Delta H_r=0$) which occurs at $x_o=0.230$.

The efficiency of a reforming process is defined as the lower heating value of hydrogen produced divided by the lower heating value of fuel consumed. Further evaluation of this simple model reveals that the peak efficiency of autothermal reforming of methanol occurs at the thermoneutral point, as seen in Fig. 2 (Ahmed, 2001). The peak efficiency of autothermal reformation of methanol at the thermoneutral point $x_o=0.230$ is 96.3%, which is one of the highest theoretical efficiencies of autothermal reformation of various hydrocarbon fuels (Krumpelt, 2002). Therefore, it is most desirable to operate as close to the

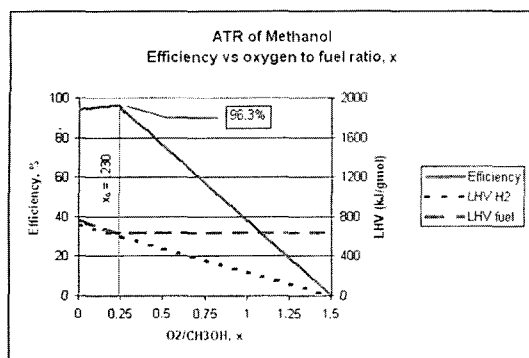


Fig. 2 Efficiency of ATR of methanol vs. oxygen fuel ratio

thermonuetral point as possible if efficiency is a priority.

It is important to note that below the thermoneutral point ($x < x_0$) the reaction is endothermic and thus requires a heat input. This heat input is assumed to be provided by combusting additional fuel, which is the most practical means for producing heat on board a vehicle. Also, the amount of energy required to heat the reactants is not included in this efficiency. The amount of excess water in the reaction would play a great role in the amount of heat required to increase the temperature of the reactants. It is also possible to utilize waste heat from the fuel cell which would effectively increase the efficiency at lower oxygen to fuel ratios, increasing the emphasis toward a steam reforming reaction.

These chemical reaction equations assume that reactions are ideal; the fuel is completely converted and all carbon monoxide that might form is reacted in a water-gas shift reaction to form carbon dioxide and more hydrogen. It is assumed that the oxidant is the limiting reactant and therefore only the minimum amount of water required to complete the reaction is considered. The equations also assume a limited number of product species when in reality there are many other possible products such as carbon monoxide, methane, solid carbon, and unconverted fuel, to name a few. These equations are effective in quantifying the ideal operating stoichiometry for maximum efficiency, based on the assumption of an ideal reaction. However, it does not account

for reaction temperature, incomplete conversion, or additional product species, which are important variables to consider.

A more detailed model was created based on equilibrium calculations. The equilibrium calculations include the additional product species carbon monoxide, unconverted methanol, and carbon. These are all unwanted but likely products and should be considered to give a more realistic simulation of the actual reaction. Methane was initially considered as a product for the equilibrium calculations, as it is a typical byproduct of ATR. However the equilibrium calculations showed overly high methane product and unrealistically low hydrogen output. Therefore, the equilibrium calculations need to be adjusted to better fit the experimental system. The mole fraction of each species in the product of the reaction is calculated based on the stoichiometry of the reactants and the operating conditions. These equilibrium mole fraction values are one of the outputs of the model and are generated using STANJAN and input into an array of data for discrete values of S/C , oxygen to fuel ratio, and temperature. An example of the products of the reaction as a function of each of these inputs can be seen in the figures below.

The equilibrium calculations show the trends that the reaction has with respect to different operating parameters. The products of the reaction depend heavily on the stoichiometry, S/C and oxygen to fuel ratio. For the most part, all oxygen is reacted at equilibrium, the fuel is nearly 100% converted, and coke formation is negligible. Looking only at the mole fraction of hydrogen in Fig. 3, a S/C of around 0.5 is an optimal value. However, taking into account the fraction of carbon monoxide in the products and the fact that it is poisonous to a PEM fuel cell, a S/C of 1.5 is more practical since the fraction of carbon monoxide at this level is nearly zero. A higher S/C also inhibits undesired coke formation (Ahmed and Krumpelt, 2001). It is also apparent from, Fig. 4, that the oxygen to fuel ratio should be minimized in order to obtain high concentrations of hydrogen in the product gas. As oxygen to fuel ratio increases, the hydrogen concentration in

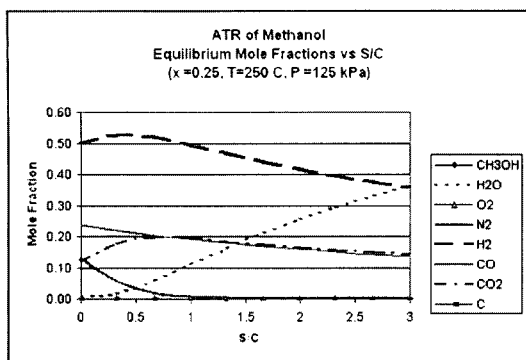
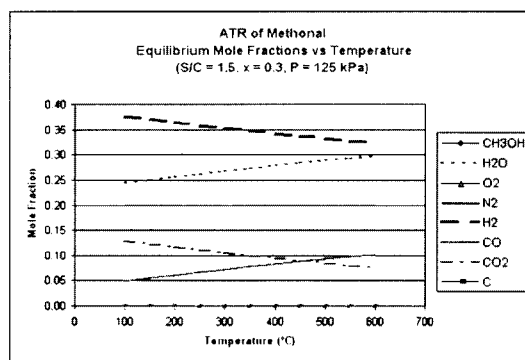
Fig. 3 Mole fractions of products vs. S/C 

Fig. 5 Mole fraction of products vs. temperature

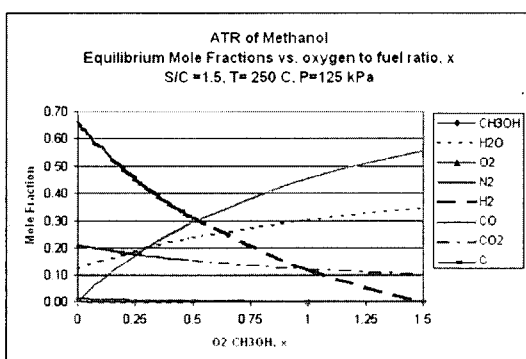


Fig. 4 Mole fractions of products vs. oxygen to fuel ratio

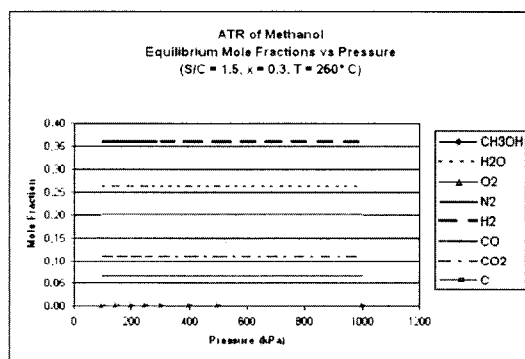


Fig. 6 Mole fractions of products vs. pressure

the product gas decreases until it reaches zero at complete combustion, $x=1.5$. Figure 5 shows that it is desirable to minimize the operating temperature for a high hydrogen output. Hydrogen output gradually decreases as temperature increases from 100 to 600°C. As seen in Fig. 6, changes in pressure (up to 10 MPa) do not appreciably affect the calculated equilibrium ratios of the products and therefore the pressure was assumed to be constant in the model. These graphs only display the dependence of the equilibrium on one variable and do not show how the different parameters are correlated.

The model interpolates between discrete operating points to find the predicted output of the reactor. Heating requirements are also calculated as an output of the model, based on inputs of the reactant flowrates and the heat of reaction. Using this refined model allows the prediction of the formation of carbon black in the reaction and

conversion of fuel. This model also shows the effects of excess water caused by a high steam to carbon ratio, reflected in both the amount of CO in the product gas and the amount of energy required to vaporize and preheat the reactants.

The equilibrium model gives a good indication of what the actual products of the ATR reaction might be. However real reactions do not necessarily reach equilibrium, depending on reactant flow rates and fuel conversion. A catalyst speeds the conversion and effectively opens new pathways for the reactants to be converted into different products not available without the catalyst. The actual effect of the catalyst will be quantified in future research. The equilibrium model gives an indication of the general direction that the reaction takes. A correction factor is added to account for the water gas shift reaction that may occur within the catalyst bed. This factor simply accounts for the possibility of H_2O and CO being converted to CO_2 via the water gas shift reaction

as previously described in Eq. (2). The correction factor will be used to better match the model outputs to actual data, based on CO concentration in the product, and will be determined experimentally. It is necessary to compare the data that will be collected during research with the model's predicted performance in order to verify the model's validity.

The inputs for the equilibrium model are flow rates of methanol, water, and air while the outputs are S/C , oxygen to fuel ratio, heating requirements, mole fraction of products, and gas hourly space velocity (GHSV). GHSV is a quasi non-dimensional parameter that can be used to help characterize the operating conditions of an autothermal reformer. The experimental system is similar in nature to a plug flow system.

$$GHSV = \frac{\sum \dot{V}_{reactants}}{V_{catalyst}} \quad (8)$$

The GHSV of a reactor can be defined in various ways. Based on the catalyst manufacturer's data, GHSV is defined as the total volumetric flow rate of reactants (at standard temperature and pressure conditions) divided by the total catalyst volume. The units of GHSV are h^{-1} .

4. Design of Autothermal Reformer

Reforming infrastructure includes a liquid pumping subsystem, a three phase vaporizer and superheater subsystem, a condensing subsystem, a gas sampling subsystem, and control switches that are remotely controlled by a computer program (Davieau, 2004). The design of the autothermal reformer took into consideration the available infrastructure and underwent many revisions during its completion. The final design includes six subsystems, the first four consisting of the previously mentioned available infrastructure and two more which are unique to the autothermal reformer: the air supply subsystem and the catalyst housing subsystem.

The primary design parameter of the autothermal reformer was power output. Flowrates were sized for a power output of 1 kW and anticipated GHSVs of anywhere from $1,000h^{-1}$ to

$100,000h^{-1}$. A monolithic catalyst was selected and specially manufactured such that various catalyst placements were possible. The catalyst has a 1.5" diameter and there are two pieces of 1.5" length and twelve pieces of 0.25" length. With these dimensions, one 1.5" length of catalyst can be replaced with six of the smaller catalyst pieces so that varying catalyst arrangements can be tested.

As shown in Fig. 7, the process of reformation begins with a reservoir filled with deionized water and fuel, placed on a digital mass scale. The fuel and water are pumped into a three-stage vaporizer, changing them from liquid to gas, and raising the gas to a desired temperature. Depending on the experimental procedure, the gaseous species can then be routed into an exhaust, or directed through a superheater by utilizing valves placed in the system. The superheater then maintains the species at a constant temperature as it is routed into the catalyst housing. Oxidant is added at this point, just after the superheater but before the catalyst housing. The oxidant is supplied from air that is available in the laboratory from an air compressor. The air is first cleaned of particulate matter and any oil from the compressor that may contaminate the air, as well as dehumidified to maintain an accurate S/C , and then metered through a mass flow controller. Then, it is heated and joined with the other reactants just before the catalyst bed. After passing through the

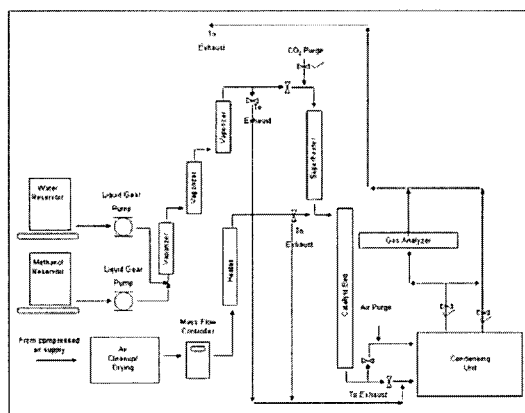


Fig. 7 Simplified schematic of ATR reforming system

catalyst bed, the gaseous species is then directed into two tubes via a system of valves. One route is for analysis and the other is for exhausting the reaction products. Both routes pass through the condensing unit where the species, now called "reformat," is cooled. Liquid water and un-reacted methanol are separated from the mixture of dry gases by a condenser and condensate trap. The dry gases are then routed to a gas analyzer for testing of gas composition.

The model developed in conjunction with available infrastructure allows proper sizing of the individual components required to construct the hardware for the autothermal reformer. These components include, air mass flow controller, air drying train and cleanup unit, air heating system, and catalyst housing.

The pumping subassembly consists of two gear pumps and two digital mass scales which are linked to a computer program that controls the pumps and records readings from the scales. The pumping system can be used to supply either a premix of liquid fuel and water, to give a highly accurate S/C ratio, or liquid fuel and water separately, to give more control over the stoichiometry of the reforming reaction. The latter scenario may also be used for experiments on reactant mixing. Reactants that are well mixed should react more efficiently than reactants that have locally varying stoichiometry. The option to supply fuel and water separately also enhances the ability to test different startup and shutdown procedures.

The vaporizer subassembly performs two tasks. First, it vaporizes the liquid reactant and, secondly, it brings these reactants up to the desired operating temperature. It does so in three different stages and then sends the fuel to a super heater to ensure that there is no possibility of condensation of liquid on the catalyst. The energy for each vaporizer is supplied from a 120V cartridge heater. The temperature of each vaporizer is monitored by two, K-type thermocouples to allow for temperature control. External heating is applied to the superheater using four 120V nozzle band heaters each rated at 275W. Three thermocouples were strategically adapted to the superheater to monitor performance and thus allow optimum

temperature control.

The air supply subsystem provides oxidant for the autothermal reaction to take place. In order to accurately control the air flowrate, it is necessary to have two different sizes of mass flow controllers (MFC), one for high space velocity testing and another for low space velocity testing. This allows for sufficient control of the stoichiometry over a full range of GHSV's. To simulate a more realistic fuel reformer, as well as to reduce recurring operational costs, it was decided that compressed air would be used as an oxidant supply rather than bottled oxygen or air. An air cleanup and drying train is then necessary to supply clean air to the MFC. A pressure regulator is also included before the MFC to regulate the pressure to within the MFC specifications. The air is then piped through a heating unit, which utilizes a 120V cartridge heater, before joining the other reactants in the catalyst housing. Valves are employed to allow control of the air into the catalyst bed housing. During start up the air is directed through the catalyst housing to allow for warm up. Then it is routed to an exhaust and the catalyst housing is purged of oxidant so that the other reactants can be introduced to the catalyst housing. This prevents high initial oxygen to fuel ratios that could potentially cause catalyst sintering.

The catalyst housing is where the actual reforming reaction takes place. It must be able to withstand temperatures up to about 800°C. For this reason the reactor housing is made of a 1.5" stainless steel pipe. The internal diameter of the pipe is 0.15" larger than the catalyst so that a catalyst wrap material can be employed to provide a friction fit of the catalyst inside the housing. The housing is much longer than the monolithic catalyst to allow for variable positioning of the catalyst (i.e. separating the catalyst pieces) as well as for testing various enhancement methods. Pelletized catalyst can be placed on screen elements within the reactor. Thermocouple ports are placed along the sides of the housing as well as at the end caps of the housing. This allows for a multitude of options for measuring catalyst temperature. The axial thermocouples placed in the

end caps are vital for collecting catalyst bed temperatures. The thermocouples are small enough to fit inside each channel of the monolith catalyst substrate so that temperature profiles of the reaction can be obtained. Pelletized catalyst temperature will be monitored with these same thermocouples. In order to adequately seal the thermocouple ports from dangerous hydrogen leaks, and also to prevent heat conduction along the thermocouple, the thermocouples are channeled through a ceramic thermocouple insulator and sealed with a high temperature sealant. The manufactured thermocouple unit is then routed through a compression fitting that uses graphite ferrules to supply the gas seal.

The condensing subsystem is responsible for condensing all of the water and unconverted methanol from the effluent for analysis. It is a simple system that consists of a refrigeration box and a pump that pumps ice water to heat transfer units that were constructed in house. The remaining gaseous products are then sent to a gas analyzer for measurement of the mole fraction of each species.

5. Conclusions

Preliminary test results, using the above designed experimental system, have shown 99% conversion of methanol fuel at GHSV's as high as $140,000\text{h}^{-1}$, for $x=0.23$, $S/C=1.5$, and inlet temperatures of 350°C . Hydrogen concentrations as high as 50% (dry gas, water and unconverted methanol condensed out of products) have been measured at multiple reactant flowrates. The modified equilibrium model of autothermal reformation will be validated once additional data has been collected. This will lead to a better understanding of the how the autothermal reaction proceeds for multiple fuels and at various stoichiometries, as well as the effectiveness of different enhancement schemes. Future designs for autothermal reforming reactors will benefit from the knowledge gained in creating an accurate model for the ATR reaction.

Acknowledgments

This work was supported by the 2005 Inje University research grant. Dr. Hyung-Man Kim would like to thank the researchers at the UC Davis Hydrogen Production and Utilization Laboratory for supporting this work.

References

- Aasberg-Peterson, K. et al., 2003, "Recent Developments in Autothermal Reforming and Pre-Reforming for Synthesis Gas Production in GTL Applications," *Fuel Processing Technology*, 83, pp. 253~261.
- Ahmed, S. and Krumpelt, M., 2001, "Hydrogen from Hydrocarbon Fuels for Fuel Cells," *International Journal of Hydrogen Energy*, 26, pp. 291~301.
- Barge, S. and Woods, R., 2001, "Fuel-Flexible, Fuel Processors (F3P)-Reforming Infrastructure Fuels for Fuel Cells," SAE 2001-01-1341.
- Davieau, D., 2004, *An Analysis of Space Velocity and Aspect Ratio Parameters in Steam-Reforming Hydrogen Production Reactors*, Masters Thesis, University of California, Davis.
- Docter, A. and Lamm, A., 1999, "Gasoline Fuel Cell Systems," *Journal of Power Sources*, 84, pp. 194~200.
- Erickson, Paul A., 2002, *Enhancing the Steam-Reforming Process with Acoustics: An Investigation for Fuel Cell Vehicle Applications*, Ph.D. Dissertation, University of Florida, Gainesville.
- Flynn, T. J. et al., 1999, "On-board Hydrogen Generation for PEM Fuel Cells in Automotive Applications," SAE 1999-01-1320.
- Gay-Desharnais, S. E. et al., 2002, "Investigation of Hydrogen Carriers for Fuel-Cell Based Transportation," SAE 2002-01-0097.
- Hagh, Bijan F., 2003, "Optimization of Autothermal Reactor for Maximum Hydrogen Production," *International Journal of Hydrogen Energy*, 28, pp. 1369~1377.
- Hoogers, G., 2003, *Fuel Cell Technology Handbook*, CRC Press.
- Krumpelt, M. et al., 2002, "Fuel Processing

for Fuel Cell Systems in Transportation and Portable Power Applications,” *Catalysis Today* 77, pp. 3~16.

Larminie, J. and Dicks, A., 2003, *Fuel Cell Systems Explained*, John Wiley & Sons Ltd., Chichester, England.

Lindstrom, B. and Lars J. Pettersson, 2003,

“Development of a Methanol Fuelled Reformer for Fuel Cell Application,” *Journal of Power Sources*, 118, pp. 71~78.

Simmons, T., 2003, *Characteristics of Hydrogen Production Via Iso-octane Autothermal Reforming For Fuel Cell Vehicles*, Ph.D. Dissertation, University of Florida, Gainesville.