

# Position Control of Shape Memory Alloy Actuators Using Self Tuning Fuzzy PID Controller

Kyoung Kwan Ahn and Bao Kha Nguyen

**Abstract:** Shape Memory Alloy (SMA) actuators, which have the ability to return to a predetermined shape when heated, have many potential applications such as aeronautics, surgical tools, robotics and so on. Although the conventional PID controller can be used with slow response systems, there has been limited success in precise motion control of SMA actuators, since the systems are disturbed by unknown factors beside their inherent nonlinear hysteresis and changes in the surrounding environment of the systems. This paper presents a new development of a SMA position control system by using a self-tuning fuzzy PID controller. This control algorithm is used by tuning the parameters of the PID controller thereby integrating fuzzy inference and producing a fuzzy adaptive PID controller, which can then be used to improve the control performance of nonlinear systems. The experimental results of position control of SMA actuators using conventional and self-tuning fuzzy PID controllers are both included in this paper.

**Keywords:** Fuzzy, PID, real time, self-tuning, SMA actuators.

## 1. INTRODUCTION

SMA is smart material that exhibits shape memory. This occurs through a solid-state phase change by molecular rearrangement. The two phases that occur in SMA are martensite and austenite. At higher temperatures, the material is in the austenite phase. As the temperature is lowered, the material changes to the martensite phase and grows until sufficiently low temperatures. This unusual characteristic of SMA actuators has a wide variety of applications in control systems beside conventional types such as electric, hydraulic, and pneumatic actuators. Although the number of applications is increasing [1-4], there has been limited success in precise motion control since the control systems are disturbed by unknown factors in addition to the nonlinear hysteresis effect and changes in the surrounding environment of the systems. These causes lead to inaccuracy and reduce the performance of the control systems.

In order to reach better control performance for the

SMA actuator systems, some control methods have been proposed to compensate for nonlinear hysteresis behaviour. Compensation of hysteresis effect for SMA, piezoceramics [5] and electro – magnetics actuators [6] have been addressed in some reports. Most of these works require a precise system model. This makes the controller synthesis complicated and time consuming. Usually the Preisach model of hysteresis based on phenomenological nature [7-9] is developed. The Preisach model is also inverted and then incorporated in an open – loop control system to achieve the desired output [5]. Although the Preisach model has found widespread acceptance in managing the major features of the hysteresis phenomena, there have been some restrictions on the accuracy and computation time for implementation of this model. These restrictions are caused by the limitation of switching points in the Preisach plane, the inaccuracy of data measurement and time consuming data collection from first order transition curves. The hysteresis model is interpreted in terms of phase shift, and a linear controller is used for hysteresis compensation in this approach [10,11]. The advantage of this method is its simplicity. However, it requires estimation of the frequency range of the system's operation.

This paper presents a new development of a SMA position control system by using a self-tuning fuzzy PID controller. Fuzzy control provides a convenient method for constructing nonlinear controllers via the use of heuristic information. The self-tuning fuzzy PID controller, i.e., the combination of a conventional PID and fuzzy controller, has been an effective tool

---

Manuscript received March 6, 2006; revised July 8, 2006; accepted July 21, 2006. Recommended by Editorial Board member Seung-Bok Choi under the direction of Editor Jin Young Choi. This study was supported by BK21.

Kyoung Kwan Ahn is with the School of Mechanical and Automotive Engineering, University of Ulsan, San 29 Muger 2 dong, Namgu, Ulsan 680-749, Korea (e-mail: kkahn@ulsan.ac.kr).

Bao Kha Nguyen is with the Automatic Control Department, Faculty of Electrical and Electronic Engineering, Hochiminh City University of Technology, 268 Ly Thuong Kiet, Street, District 10, Hochiminh City, Vietnam (e-mail: nbkha@hcmut.edu.vn).

for the self-tuning control of many nonlinear systems [12-15]. Therefore, it is suitable for application in SMA systems with unknown elements and the hysteresis nonlinearity effect. This control algorithm tunes the parameters of the PID controller by integrating fuzzy inference and producing a fuzzy adaptive PID controller. This work can be used to improve the accuracy of the displacement and therefore compensate for the nonlinearity hysteresis of SMA actuators. Real time control using the proposed control algorithm, and the effect of the control performance with respect to the input current changes are investigated in the SMA actuator system.

The remainder of the paper is organized as follows: The design of self tuning fuzzy PID controller for SMA actuators is presented in Section 2. The comparison of experimental results of SMA position control between conventional PID and the proposed self tuning fuzzy PID is described in Section 3. Concluding remarks are provided in Section 4.

## 2. SELF TUNING FUZZY PID CONTROLLER DESIGN

### 2.1. Structure of self tuning fuzzy PID controller

The PID controller is widely used in industry due to its simple control structure and easy design. However, there are certain problems that are encountered in practical control systems. The parameters of the conventional PID controller are not often properly tuned for the nonlinear plant with unpredictable parameter variations. For this reason, it is necessary to automatically tune the PID parameters.

On the other hand, fuzzy control provides a formal methodology for representing, manipulating, and implementing a human's heuristic knowledge about how to control a system. This is also a convenient method for constructing nonlinear controllers by using heuristic information obtained from experience. Therefore, the advantages of fuzzy and PID controllers can be incorporated into a controller in order to achieve high control performance. The structure of the self tuning fuzzy PID controller is shown in Fig. 1.

The controller has the form of PID structure, but the PID parameters are tuned by fuzzy inference, which provides a nonlinear mapping from the error signal  $e(t)$  (the difference between reference signal and system output), and derivation of error  $de(t)$ , to the PID parameters  $K_p$ ,  $K_i$ , and  $K_d$ . These parameters are changed within the initial parameter boundaries.

### 2.2. Application of self tuning fuzzy PID controller to the position control of SMA actuator systems

This section presents the implementation of the self-tuning fuzzy PID controller for the position control of

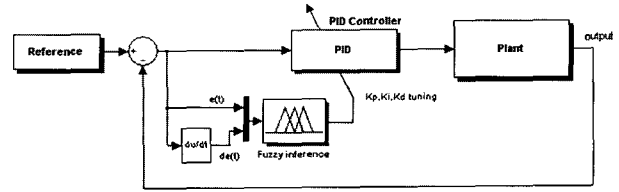

Fig. 1. Structure of self tuning PID controller.

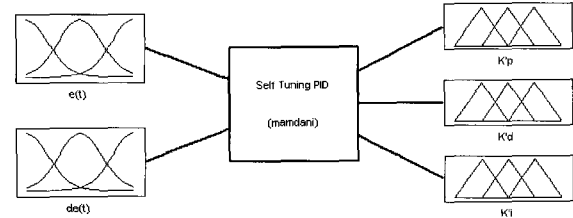

Fig. 2. Structure of the fuzzy inference block.

SMA actuators. The structure of the fuzzy inference block in Fig. 1 is shown in Fig. 2.

#### 2.2.1 Normalization

Suppose that the variable ranges of  $K_p$ ,  $K_i$ , and  $K_d$  are  $[K_{p\min}, K_{p\max}]$ ,  $[K_{i\min}, K_{i\max}]$  and  $[K_{d\min}, K_{d\max}]$ , respectively. In the position control problem of SMA actuators, the range of each PID parameter was experimentally determined as follows:  $K_p \in [0.1, 10]$ ,  $K_i \in [0.1, 0.5]$ ,  $K_d \in [0.01, 0.1]$ . In order to obtain feasible rule bases with high inference efficiency, the PID parameters must be normalized over the interval  $[0, 1]$  as follows:

$$K'_p = \frac{K_p - K_{p\min}}{K_{p\max} - K_{p\min}} = \frac{K_p - 0.1}{10 - 0.1}, \quad (1)$$

$$K'_i = \frac{K_i - K_{i\min}}{K_{i\max} - K_{i\min}} = \frac{K_i - 0.1}{0.5 - 0.1}, \quad (2)$$

$$K'_d = \frac{K_d - K_{d\min}}{K_{d\max} - K_{d\min}} = \frac{K_d - 0.01}{0.1 - 0.01}. \quad (3)$$

Therefore:  $K_p = 9.9K'_p + 0.1$ ;  $K_i = 0.4K'_i + 0.1$ ;  $K_d = 0.09K'_d + 0.01$ .

#### 2.2.2 Fuzzification

In this paper, the linguistic levels assigned to the input variables  $e(t)$  and  $de(t)$  are as follows:

NB: negative big; NM: negative medium; NS: negative small; ZO: zero; PS: positive small; PM: positive medium; PB: positive big.

The membership functions of these fuzzy sets are shown in Figs. 3 and 4. The maximum error and the maximum derivation of error ranges are chosen from

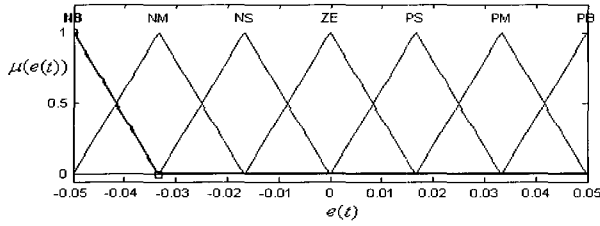

Fig. 3. Membership functions for error  $e(t)$ .

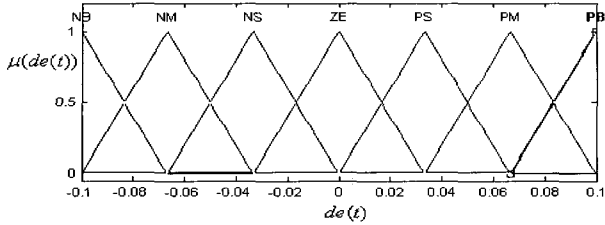

Fig. 4. Membership functions for derivation of error  $de(t)$ .

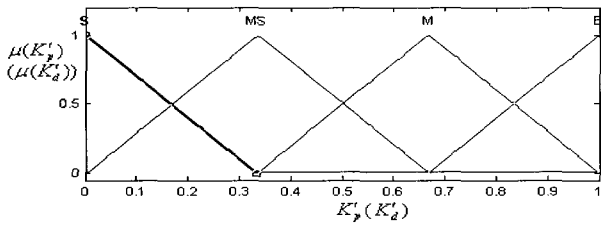

Fig. 5. Membership functions for  $K_p'$  and  $K_d'$ .

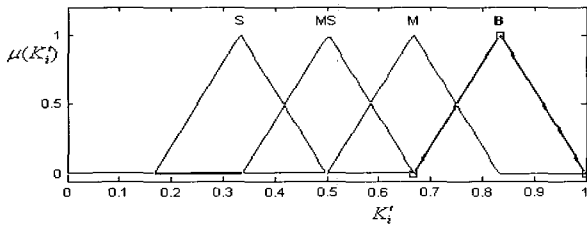

Fig. 6. Membership functions for  $K_i'$ .

the specification of SMA actuators.

S, MS, M, B are assigned as the fuzzy sets of  $K_p'$ ,  $K_d'$  and  $K_i'$  which are the output variables, and the membership functions of the fuzzy set are shown in Figs. 5 and 6, respectively.

### 2.2.3 Fuzzy rule and fuzzy inference

Using the above fuzzy sets of the input and output variables, fuzzy rules are composed as follows:

Rule  $i$ : If  $e(t)$  is  $A_1^i$  and  $de(t)$  is  $A_2^i$  then  $K_p'$  is  $B^l$ ,  $K_d'$  is  $C^l$  and  $K_i'$  is  $D^l$ ,  $l=1,2,\dots,m$ , where  $m$  is the number of fuzzy rules,  $A_1^i$  is the input fuzzy set in  $U_i \subset R$ . The fuzzy sets  $B^l$ ,  $C^l$ ,  $D^l$  are the output sets is  $O \subset R, P \subset R, Q \subset R$ ,

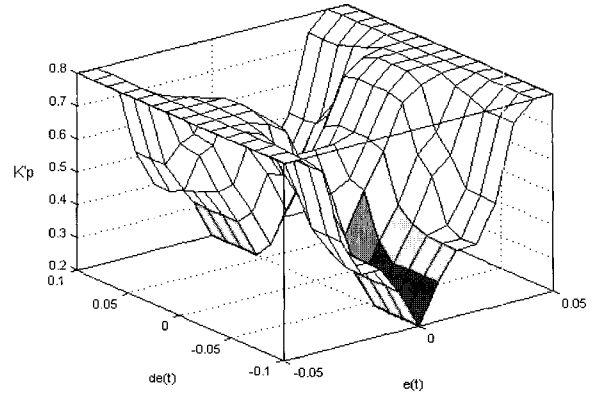

Fig. 7. Fuzzy control rule of  $K_p'$ .

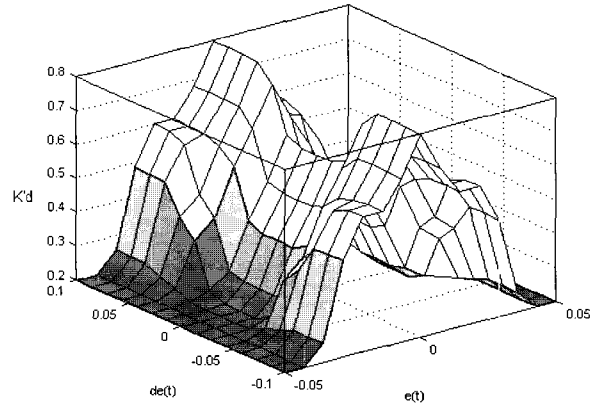

Fig. 8. Fuzzy control rule of  $K_d'$ .

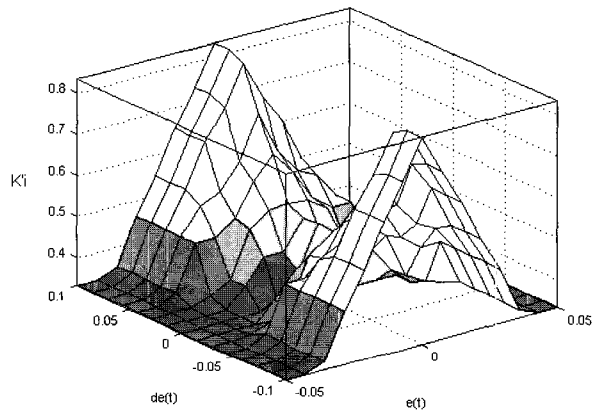

Fig. 9. Fuzzy control rule of  $K_i'$ .

respectively, and  $x = [x_1, x_2] = [e(t), de(t)]^T \in U$ ,  $K_p' \in O$ ,  $K_d' \in P$ ,  $K_i' \in Q$  are the input and output linguistic variables of the fuzzy system, respectively. For simplicity, only triangle functions are used as the membership functions, denoted by  $\mu$ , of these fuzzy sets.

Generally, the fuzzy rules are dependent on the plant to be controlled and the type of the controller. These rules are determined from intuition or practical

experience. In this paper, rules are designed based on the characteristics of SMA actuators, such as slow response or nonlinear hysteresis effect, and the properties of the PID controller. The rule sets are established and shown in surfaces in Figs. 7, 8, and 9.

In this paper, the MAX – MIN fuzzy reasoning method is used to obtain output from the inference rule and the present input. For given a specific input fuzzy set  $A'$  in  $U$ , the output fuzzy set  $B'$  in  $O$  for  $K'_p$  is computed through the inference engine as follows:

$$\mu_{B'}(K'_p) = \max_{l=1}^m [\sup_{x \in U} \min(\mu_{A'_l}(x), \mu_{A'_l}(e(t)), \mu_{A'_2}(de(t)), \mu_{B'_l}(K'_p))] \quad (4)$$

The output membership functions for  $K'_d$  and  $K'_i$  are computed similarly.

2.2.4 Defuzzification

The centroid defuzzification method is used to convert the aggregated fuzzy set to a crisp output value  $y^*$  from the fuzzy set  $B'$  in  $V \subset R$ . This work computes the weighted average of the membership function or the center of gravity (COG) of the area bounded by the membership function curves:

$$y^* = \frac{\int_V \mu_{B'}(y) \cdot y dy}{\int_V \mu_{B'}(y) dy} \quad (5)$$

We compute the crisp value of  $K'_p, K'_d$  and  $K'_i$  by using the above expression.

3. EXPERIMENTAL RESULTS

To experimentally verify the performance of above controller in the position control of SMA actuators, an experimental apparatus using a small NiTiNol SMA wire (made by Memory–Metalle GmbH) was established (Fig. 10). The main specifications of SMA wire were: length: 110mm, diameter: 250 $\mu$ m, heat current: ca.2V/0.85A, gen. force: 8N, displacement: ca. 5mm. This actuator has a one–way shape memory effect. The displacement was measured by a high precision potentiometer and fed to the computer through an A/D Advantech PCI-1711 card. The control current applied to the SMA

wire was obtained from a D/A card and a V/I converter. The sampling time was set to 0.01s in all experiments. An extra current source was also used to simulate the effect of the variation of input current.

This system was controlled in real time using the Real time Windows Target Toolbox of Matlab.

The self tuning fuzzy PID control scheme applied to the SMA actuators is shown in Fig. 11. There were two inputs to the fuzzy controller:  $e(t)$  and  $de(t)$ . The three outputs of the fuzzy controller were the normalized values of the PID parameters. These values were denormalized and then applied to the PID regulator. The input current applied to SMA actuator system was obtained from the PID controller shown in Fig. 12.

The performance of the proposed control system was experimentally investigated for different reference inputs. Fig. 13 shows the performance of the control system with respect to step reference input signal and its control signal. The system response to step reference input compared with conventional PID

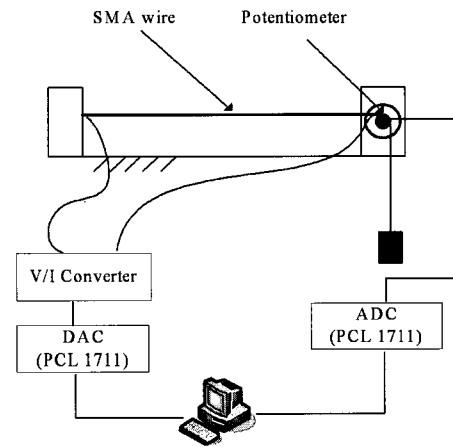

Fig. 10. Experimental apparatus.

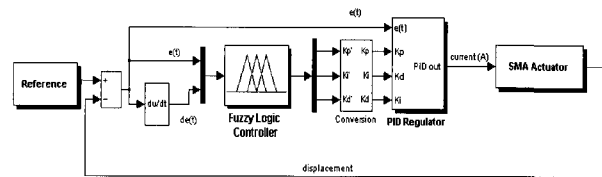

Fig. 11. Schematic diagram of self tuning fuzzy PID controller applied to SMA actuator.

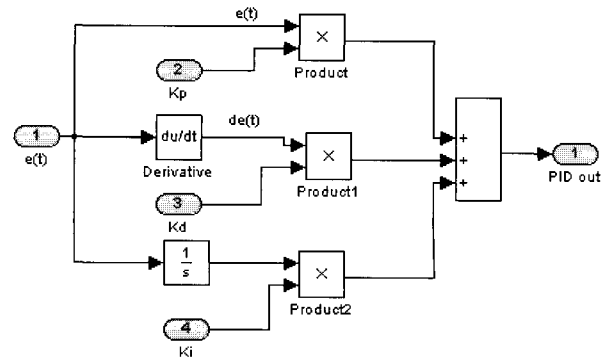

Fig. 12. The Structure of PID regulator.

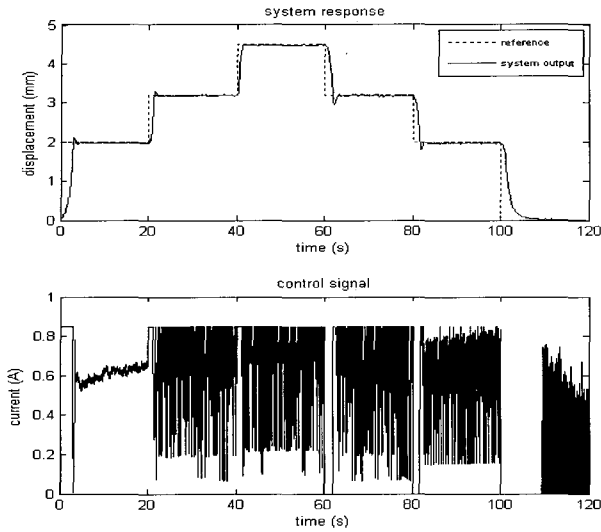

Fig. 13. Step response and control signal.

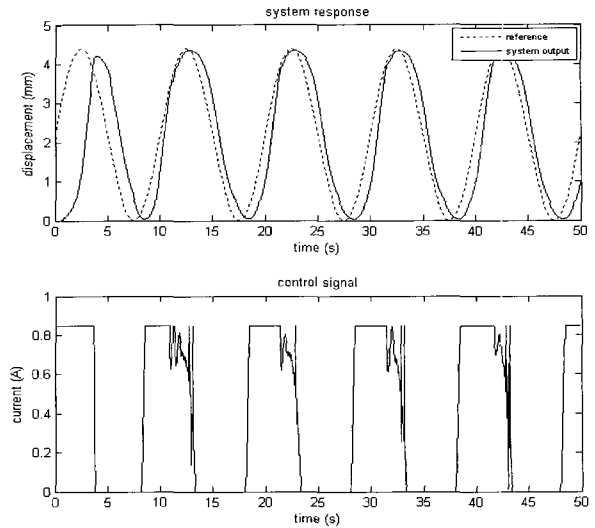

Fig. 15. System response with respect to sine reference input ( $f = 0.1\text{Hz}$ ).

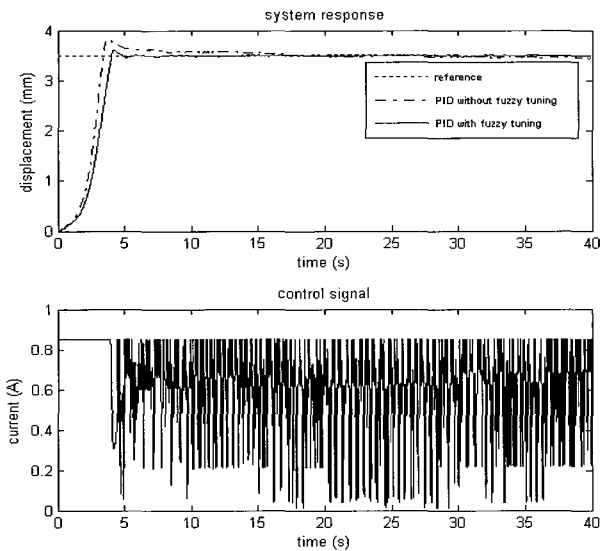

Fig. 14. Comparison of step response with and without fuzzy tuning.

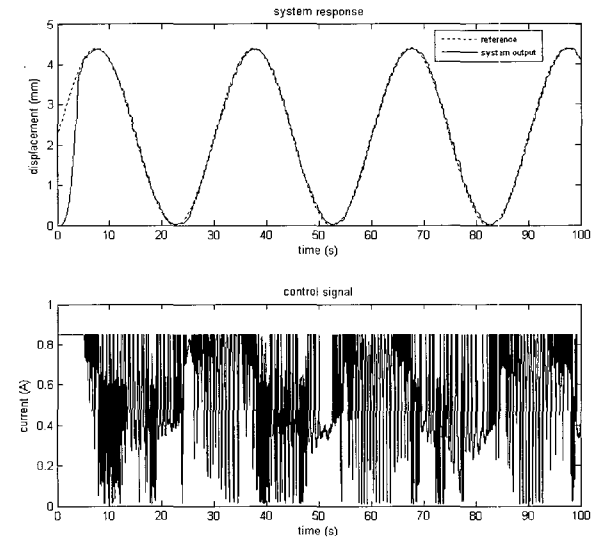

Fig. 16. System response with respect to sine reference input ( $f = 0.033\text{Hz}$ ).

control (without fuzzy tuning) is shown in Fig. 14. Figs. 13 and 14 show that the self tuning fuzzy PID controller achieves better tracking response than the conventional PID controller without fuzzy tuning.

Figs. 15 and 16 depict the performance of control system to sine reference input with two different frequencies. Steady state error is shown in Fig. 17. Since the SMA actuator is a slow response system, the control performance is better in the low frequency tracking.

The effect of a small variation of input current was also investigated and is shown in Fig. 18. The output displacement keeps good tracking adaptively with the desired trajectory even the small change of the input current.

The hysteresis curve between input and output

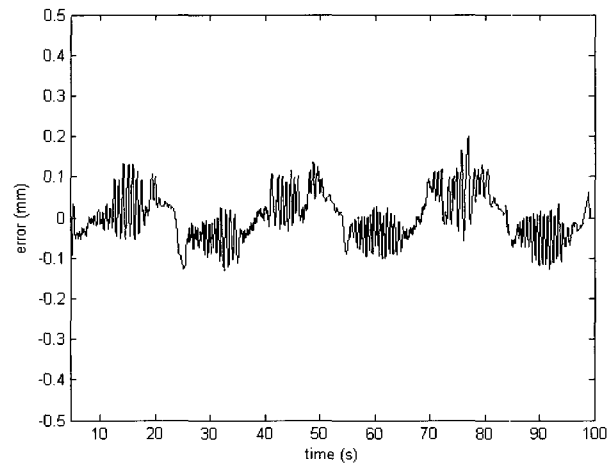

Fig. 17. Steady state error.

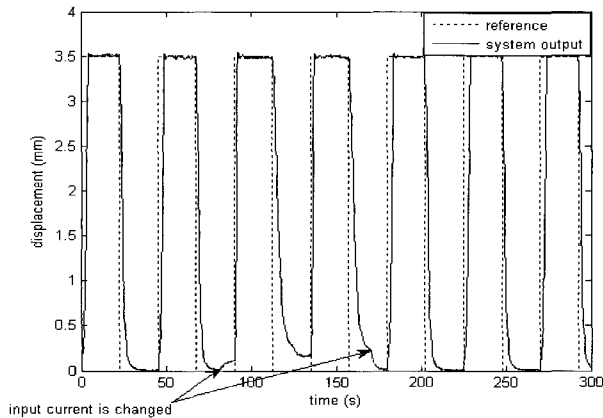

Fig. 18. Effect of the change of input current.

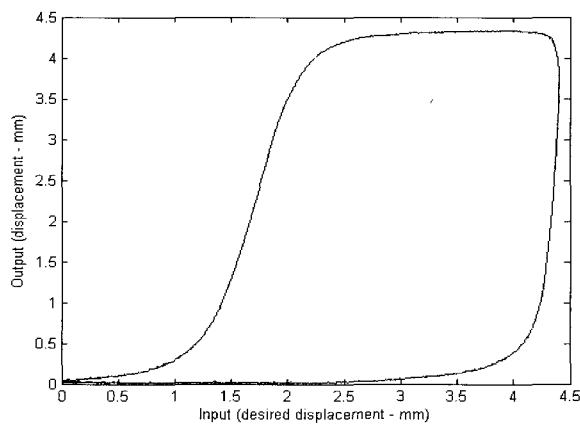

Fig. 19. Hysteresis curve obtained from experiment before applying control algorithm (open loop control).

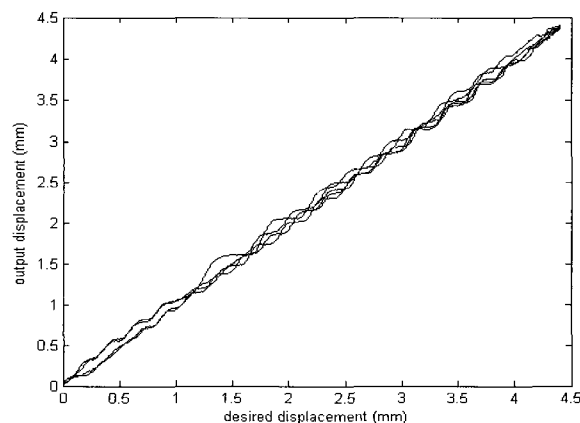

Fig. 20. Hysteresis curve obtained from experiment after applying control algorithm (closed loop control).

relation of a system including the SMA actuator and controller before (open loop control) and after applying the control algorithm (closed loop control) is shown in Figs. 19 and 20, respectively. The hysteresis curve in Fig. 20 is obtained from the second cycle of the system response with respect to the sine reference

signal shown in Fig. 16. Fig. 20 shows the nearly linear relationship between the desired displacement (input) and the system output. Consequently, the self tuning fuzzy PID control algorithm proves to be effective for the position control and hysteresis compensation of SMA actuators.

#### 4. CONCLUSIONS

In this paper, an adaptive self tuning fuzzy PID control algorithm was applied to the real time position control of SMA actuators. The experimental evaluation showed that the self-tuning fuzzy PID controller could adaptively achieve good tracking to different references, the small change of the input current, and therefore could compensate for the hysteresis phenomenon of SMA actuators. The proposed controller was compared with the conventional PID controller without fuzzy tuning and performed better. This control method is effective not only for SMA actuators but also for other control systems.

#### REFERENCES

- [1] Q. Chang-Jun, M. Pei-Sun, and Y. Qin, "A prototype micro-wheeled-robot using SMA actuator," *Sensors and Actuators A: Physical*, vol. 113, no. 1, pp. 94-99, 2004.
- [2] T. Raparelli, P. B. Zobel, and F. Durante, "Design of a parallel robot actuated by shape memory alloy wires," *Materials Transactions*, vol. 43, no. 5, pp.1015-1022, 2002.
- [3] D. D. Shin, K. P. Mohanchandra, and G. P. Carman, "Development of hydraulic linear actuator using thin film SMA," *Sensors and Actuators A: Physical*, vol. 119, no. 1, pp. 151-156, 2005.
- [4] M. Vasina, F. Solc, and K. Hoder, "Shape memory alloys, unconventional actuators," *Proc. of the IEEE Int. Conf. Industrial Technology*, vol. 1, pp. 190-193, 2003.
- [5] D. Hughes and J. T. Wen, "Preisach modeling of piezoceramic and shape memory alloys hysteresis," *Smart Material Structures*, vol. 3, pp. 287-300, 1997.
- [6] H.-J. Shieh, F.-J. Lin, P.-K. Huang, and L.-T. Teng, "Hysteresis compensation in electromagnetic actuators through Preisach model inversion," *IEEE/ASME Trans. on Mechatronics*, vol. 5, no. 4, pp. 394-409, 2000.
- [7] B. J. Choi and J. J. Lee, "Preisach model of SMA actuators using proportional relationship of major loop of hysteresis," *Proc. of IEEE Int. Conf. Intelligent Robots and Systems*, vol. 2, pp. 1986-1991, 2002.
- [8] Y. M. Han, S. C. Lim, H. G. Lee, S. B. Choi, and H. J. Choi, "Hysteresis identification of

polymethylaniline-based ER fluid using Preisach model,” *Materials & Design*, vol. 24, no. 1, pp. 53-61, 2003.

- [9] D. Mayergoyz, *Mathematical Models of Hysteresis and Their Applications*, Elsevier Science, New York, 2003.
- [10] J. M. Cruz- Hernandez and V. Hayward, “On the linear compensation of hysteresis,” *Proc. of IEEE Conf. on Decision and Control*, vol. 2, pp. 1956-1957, 1997.
- [11] J. M. Cruz- Hernandez and V. Hayward, “Phase control approach to hysteresis reduction,” *IEEE Trans. on Control Systems Technology*, vol. 9, no. 1, pp. 17-26, 2001.
- [12] R. Babuska, J. Oosterhoff, A. Oudshoorn, and P. M. Bruijn, “Fuzzy self-tuning PI control of pH in fermentation,” *Engineering Applications of Artificial Intelligence*, vol. 15, no. 1, pp. 3-15, 2002.
- [13] M. Parnichkun and C. Ngaecharoenkul, “Hybrid of fuzzy and PID in kinematics control of a pneumatic system,” *Proc of the 26th Annual Conf. of the IEEE Industrial Electronics Society*, vol. 2, pp. 1485-1490, 2000.
- [14] M. Petrov, I. Ganchev, and A. Taneva, “Fuzzy PID control for nonlinear plant,” *Proc of the First Int. IEEE Symposium on Intelligent Systems*, vol. 1, pp. 30-35, 2003.
- [15] T. Ahn, Y. W. Kwon, and H. S. Kang, “Drive of induction motors using a pseudo-on-line fuzzy-PID controller based on genetic algorithm,” *Trans. on Control, Automation and Systems Engineering*, vol. 2, no. 2, pp.85-91, 2000.



**Kyoung Kwan Ahn** received the B.S. degree in the department of Mechanical Engineering from Seoul National University in 1990, the M.Sc. degree in Mechanical Engineering from Korea Advanced Institute of Science and Technology (KAIST) in 1992 and the Ph.D. degree with the title “A study on the automation of out-door tasks using 2 link electro-hydraulic manipulator from Tokyo Institute of Technology in 1999, respectively. He is currently an Associate Professor in the School of Mechanical and Automotive Engineering, University of Ulsan, Ulsan, Korea. His research interests are design and control of smart atuator using smart material, fluid power control, rehabilitation robot and active damping control. He is a Member of IEEE, ASME, SICE, RSJ, JSME, KSME, KSPE, KSAE, KFPS, and JFPS.

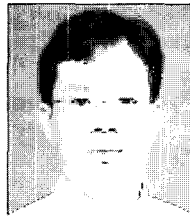

**Bao Kha Nguyen** received the B.S. and M.S. degrees from Hochiminh City University of Technology in 2001 and 2003, respectively, all in Automatic Control Engineering. He is currently studying Ph.D. Course at University of Ulsan. His research interests focus on intelligent control, modern control theory and their applications, design and control of smart actuator systems.