

DSP 마이크로컨트롤러를 사용한 CAN 네트워크 기반 유도전동기 고장진단 시스템 설계

(Design of Network-Based Induction Motors Fault Diagnosis System Using Redundant DSP Microcontroller with Integrated CAN Module)

윤충섭 · 홍원표*

(Chung-Sup Yoon · Won-Pyo Hong)

요 약

유도전동기는 프로세스산업과 다른 산업분야에 광범위하게 적용되는 매우 중요한 기기이다. 프랜트를 운전함에 있어서 이의 신뢰성, 효율 및 성능은 매우 중요한 관심사항이다. 특히 유도전동기의 고장을 미리 검출하여 진단하고 고장 아래에서도 시스템이 안전하고 신뢰성 있는 성능을 가질 수 있는 고장허용제어의 실현이 매우 중요하다. 따라서 본 논문에서는 고정자전류신호 검출과 디지털 신호 프로세싱에 의한 효과적인 유도전동기의 베어링 고장검출 및 진단 기반을 가진 고장허용제어 시스템을 구축하였다. 또한 모타 고장허용제어에 기본이 되는 제어 하드웨어 구조를 제시하였으며 실험을 통하여 이 시스템의 실시간 데이터 취득 성능을 확인하였다.

Abstract

Induction motors are a critical component of many industrial processes and are frequently integrated in commercially available equipment. Safety, reliability, efficiency, and performance are some of the major concerns of induction motor applications. Fault tolerant control (FTC) strives to make the system stable and retain acceptable performance under the system faults. All present FTC method can be classified into two groups. The first group is based on fault detection and diagnostics (FDD). The second group is independent of FDD and includes methods such as integrity control, reliable stabilization and simultaneous stabilization. This paper presents the fundamental FDD-based FTC methods, which are capable of on-line detection and diagnose of the induction motors. Therefore, our group has developed the embedded distributed fault tolerant and fault diagnosis system for industrial motor. This paper presents its architecture. These mechanisms are based on two 32-bit DSPs and each TMS320F2407 DSP module processes the stator current, voltage, temperatures, vibration signal of the motor.

Key Words : TMS320F2407 DSP, Fault detection and diagnostics, Fault tolerant control, Redundancy system

* 주저자 : 한밭대학교 건축설비공학과 교수

Tel : 042-821-1179, Fax : 042-821-1175, E-mail : wphong@hanbat.ac.kr

접수일자 : 2005년 4월 27일, 1차심사 : 2005년 5월 6일, 심사완료 : 2005년 5월 30일

1. Introduction

Today, distributed industrial control systems are becoming one of the most important areas in research of embedded-control application. In this sense, the control and supervision of these systems are accomplished through the operation of different nodes that are interconnected through industrial local area networks. The design of a distributed system, which embodies various families of sensors and transducers, requires including special capabilities to improve both the performance and reliability. Local embedded processing can provide onboard diagnostics and reliable control for critical operation. In these systems, control and monitoring system are based on the microcontrollers that have the various characteristics in the simplest or in the most complex form, and the digital communication networks. In this case of the microcontroller, the low costs of system based on microcontroller is realized and the high degree of integration achieved, because it eliminates the need of additional peripherals. The digital communication protocol binds together the more and less autonomous nodes and controls the direct and indirect interactions among them. Many of the architectural characteristics of the real-time system as a whole are determined by the properties of this communication protocol, e.g., if the system is decomposable in the domain time, or if a given deadline can be guaranteed under all specified load and fault conditions. In systems that may involve a certain risk for the users or the process under control, it is necessary to study and improve the dependability. It is defined by Laprie as 'that property of the computing system which allows reliance to be justifiably placed on the service it delivers'. When a system is able to continue its work in the presence of faults, it is called a fault tolerant system[1]. In the aspect of

control, we also consider a fault tolerant control (FTC). FTC systems, namely: control system able to detect incipient faults in sensor and/or actuators on the one hand and on the other, to promptly adapt the control law in such a way as to preserve pre-specified performances in term of quality of the production, safety, etc[2]. Further, a system is safe when in the event of a non-recovered failure, the system stops in a well-known state, which does not cause a risk to the process. The essence of fault detection and diagnostics (FDD) based FTC methods is to on-line detect and diagnose the system faults, and then to modify or redesign the control law to make the faulty system stable according to the diagnosed faults[3]. We have focused on the motor current signature analysis for bearing damage detection in Induction motors[4-6]. In this paper, the fundamental design of FTC system for induction motors (IM) is presented. IM is subjected to the rotor, stator and bearings failures caused by the combination of the thermal, electrical, mechanical, magnetic and environmental stresses. Prediction of abnormalities in the motors will avoid expensive failures. Most motor protection equipment is typically aimed at protecting the motor insulation against overheating. Additional protection can be gained by applying expensive equipment based on sensing vibration and/or the current spectra of motor to predict incipient failures.

This article proposes a redundant system in sense of dual sensors, dual DSP and dual field bus to protect the motor failures and notify the result on field bus. And the dual shared data is treated by digital input/output, SPI communication and hardware semaphore through each DSP.

2. Design of Redundancy system

A redundancy system would address as follows:

dual sensing for voltage, current, temperature and vibration, a device-level communication for each DSP for making decision from shared data, redundant transmission of message on field bus.

The proposed redundancy system is shown in Fig. 1. We can see that the structure of nodes is based on:

- Two 32-bit DSP microcontrollers that are in charge of controlling, monitoring the industrial process and detecting and diagnosing the induction motor faults. After the control and command data is processed and executed, they are sent the pertinent data and information to a built-in CAN controller. This host controller has a powerful 32bit microcontroller with a built-in CAN controller many input/output ports.

- Dual-port static RAM to pass information between both microcontrollers and to store the node state. High-speed dual-ported RAM interface sends and receives hundreds of packets per second with minimum host overhead.

- Communication networks based the CAN protocol, two communication networks, both of them can be accessed by both microcontrollers.

- A serial RS-232C is included for 32-bit DSP microcontroller in order to make local channels possible in each node, and also to allow software updates via RS-232 for microcontroller. We get the final data processed and operated from DSP chip through RS-232 port. Further, this can use to the gateway to translate CAN protocol to RS-232.

- The Transceiver

A transceiver provides the mechanical and electrical interface between the two DSP microcontrollers and the communication medium. Multi-medium transceivers enable the actuator and sensors to operate in different environment.

- Two identical 32-bit microcontrollers, the first one is in charge of the communication and the application execution. In case of failure, the fault

free microcontroller will perform all the function of the system. As can be seen, both microcontrollers receive signals from the sensors and send signals to the actuators, and they are also connected to two local area networks.

The phase motor current is sensed with hall sensor. The stator current monitoring system contains the four processing section illustrated in Fig. 2 such as a sampler, preprocessor, fault detection algorithm and postprocessor. The sampler includes three components of analog 60[Hz] notch filter, low pass filter and A/D converter. The line-line voltage is sensed using potential transformers. Rolling element bearings generally consist of two rings, an inner and outer, between which a set of balls or rollers rotate in raceways. Two temperature sensors are inserted at near motor stator and outer bearing raceway, respectively. Piezo vibration sensor also is inserted at outer bearing raceway. The current signal is passed through a notch filter to remove the overwhelming 60[Hz] component, then through low-pass filter (2[kHz] cutoff frequency). All signal's digital values are obtained by ADC of TMS320LF2407 (Fig.3) by a sequential order. A redundancy hardware part are placed the side of it (Fig. 4). 3 levels do communication between two DSPs, GPIO (general purpose input output) like hardware interrupt as a hardware fault tolerant system as first level, SPI protocol as device-level communication and shared memory space on a dual port RAM implemented by hardware semaphore as upper level. Two field protocol are supported; RS485 and CAN. Both fieldbus protocol has two redundancy buses for reliable control of the designated motor. Although control area network (CAN) is intrinsically a two wire system with strong error detection and its handling capabilities. It is usually considered a channel system. Two busses achieve a redundancy bus

system. All these system and the proposed one have the basic principles of the operation in common. There are little differences from each other in the communication channel or links between elements and their purpose. The following common aspects can be mentioned:

- A microcontroller carry out two roles such as communication tasks and execution of the application;
- The interface among both microcontrollers is based on a dual port RAM implemented by hardware semaphore as upper level

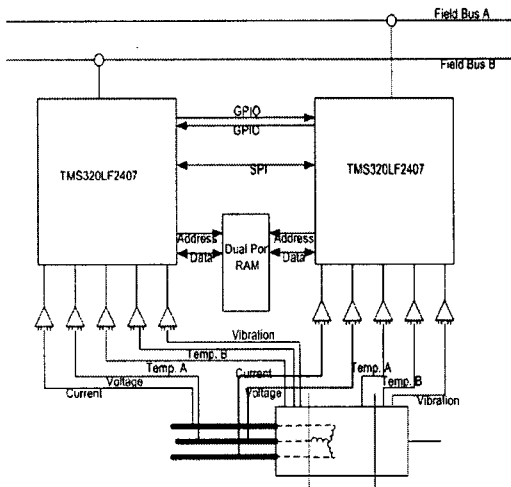

Fig. 1. Block diagram of redundancy system

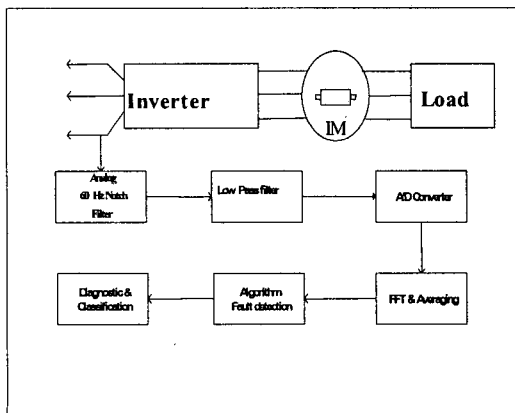

Fig. 2. Block diagram of single phase stator current monitoring scheme

Table 1. Specification of sensors

Items	Specification		
	Type	Data	Accuracy
Current Transducer	LA55-P	Primary current, measuring range $\pm 70[A]$	$\pm 0.65[\%]$
Voltage Transducer	LV 25-P	Measuring range : 500[V]	$\pm 0.9[\%]$
Temperature sensor	LM35	$-55[^\circ C]$ - $150[^\circ C]$	$0.5[^\circ C]$
Linear vibration sensor	D7F-S03-05	Frequency range: 10-2,000[Hz]	$\pm 5[\%]$
Encoder	RIA-80	Resolution: 1024 Max. frequency: 100[kHz] Max. revolution: 6,000[rpm]	

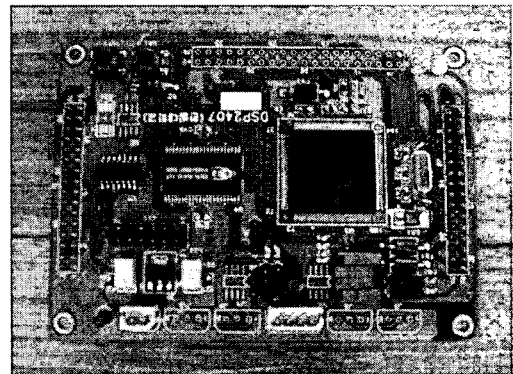

Fig. 3. View of TMS320LF2407 DSP module

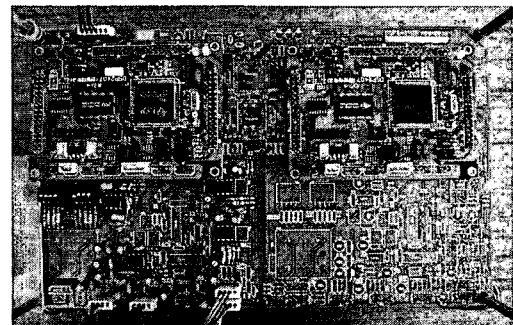

Fig. 4 View of redundancy system

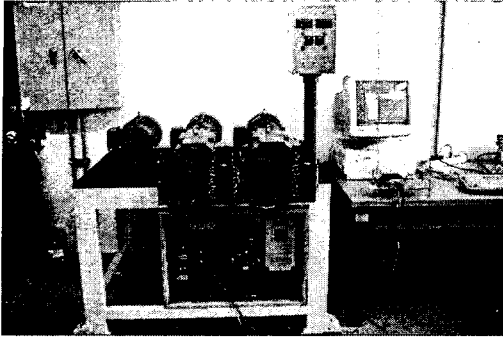

Fig. 5. View of experimental setup

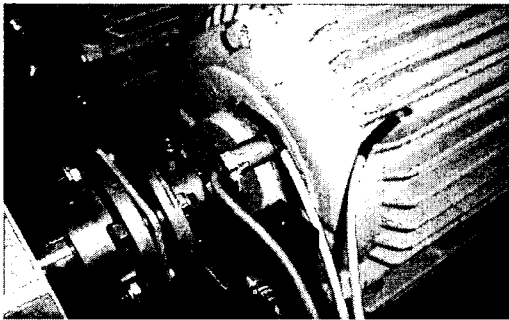

Fig. 6 View of vibration and thermal couple sensor for bearing and thermal couple sensor for stator temperature

The fault-tolerant distributed system is based on a set of nodes connected by two CAN protocol. Over CAN, we use the application layer proposed by CAN in Automation called CAN Application Layer (CAL). In order to determine the domains where the distributed system can be applied, it is necessary to analyze its performance and dependability, in the first stages of its conception. Thus, the first stage in the research is focused on the design of distributed systems. The main goals of this stage are:

- To analyze different fault-tolerant architectures for the nodes of the distributed system;
- To determine the performance of a CAN network used as the backbone of an industrial distributed system. The objective is the evaluation of the system performance, for different architecture with different CAN controllers; and

- To develop hardware and software tools to monitor the performance of system and to detect the induction motor faults.

The main idea under the conception of the distributed architecture based on small nodes is that system nodes should be cheap, simple and flexible. The main objective is that from the basic architecture we should be able to add fault tolerance mechanisms to increase the reliability and safety of the nodes but at a low cost

3. Experimental Setup and Results

Fig. 5 shows an experimental setup, where the redundancy system and induction motors with normal condition motor, and two abnormal condition motors; a hole was drilled through the outer race of the shaft-end bearing and an external eccentric force applied the motor shaft. The collected signals are sent to PC through a bus.

Any air gap eccentricity by a holed bearing and eccentric shaft and others produces abnormal air gap flux density. By these eccentricity varied with rotor position, the oscillation in the air gap causes the variation in the air gap flux density. In turn, this affects the motor inductances and produce stator current harmonics (see the current signals of Fig. 7~9)[5,6]. The data is taken from 1.5[kW] motors at 1000[rpm] with 4[kHz] sampling rate. We set the experimental test bed to detect the rolling element bearing system of 1 type induction motor with normal condition bearing system and 2 type induction motor with shaft deflection system by external force and a hole drilled through the outer race of the shaft end bearing of the four pole test motor. Fig. 7 shows the signals of phase current, vibration, and two temperature sensors for the normal condition motor. These sensors for the current, vibration and temperature of the stator

and bearing are located on the shown Fig. 6. In the cases of abnormal conditions, Fig. 7 describes the sensor signals of the holed bearing and the sensor signals of the eccentric motor shaft is also shown in Fig. 8.

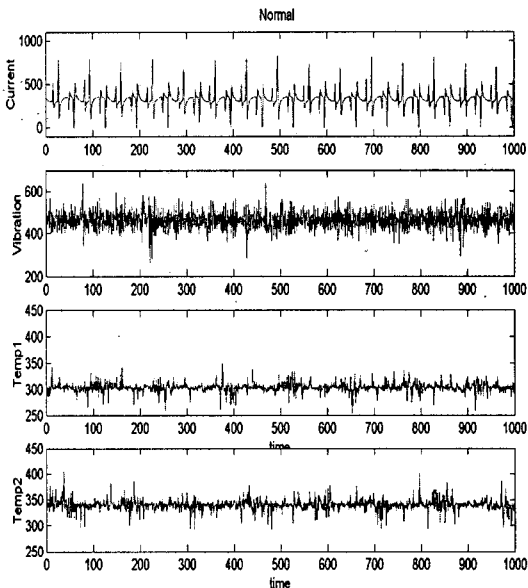

Fig. 7. Measured sensor signals of normal condition motor

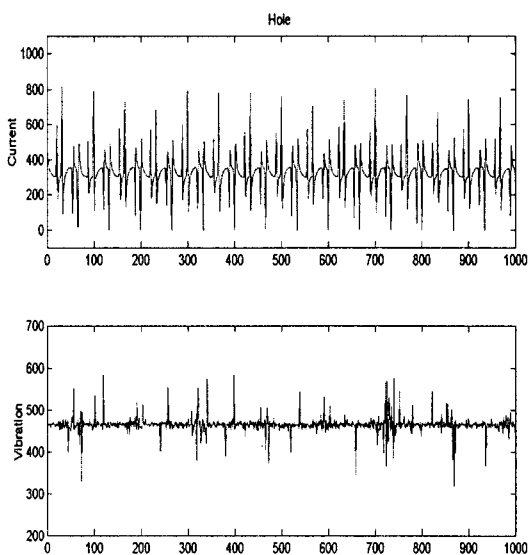

Fig. 8. Measured sensor signals of the holed bearing

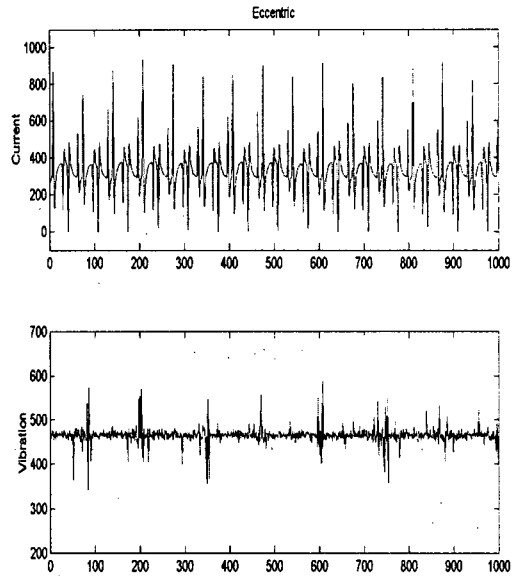

Fig. 9. Measured sensor signals of the eccentric motor shaft

4. Conclusion and Discussions

Modern manufacturing and process systems need improvement in their dependability. In this paper we researched a fundamental fault tolerant techniques applicable in distributed process control systems. The operations of the prototype device have been successfully demonstrated for real time validation of sensor data. The several approaches of spatial redundancy at node level are presented. We have also demonstrated our proposed motor protection redundancy system in this paper and have studied the common application layers used in CAN networks to add the necessary mechanisms to develop a fault-tolerant node. And, then we presented the sensor data signals obtained from our designed system. The dual DSPs will make an independent decision from these sensors, and then notify 3 level communications for fault tolerant. Also, this system supports dual field bus system. In near future, we will implement a distributed real time system to control the

multi-motor system to be connected to CAN fieldbus.

The authors would like to gratefully acknowledge the financial support of KESRI (Korea Electrical Engineering & Science Research Institute) under project R-2003-B-285.

References

- (1) J.C Campelo et al., "Distributed industrial control system: a fault tolerant architecture", *Microprocessor and Microsystems* 23, pp. 103-112, 1999.
- (2) C. Bonivento et al., "Implicit fault-tolerant control: application to induction motors", *Automatica* 40, pp. 355-371, 2004.
- (3) D.H. Zhou, "Fault Diagnostics and Fault Tolerant Control," *IEEE Trans. On Aerospace and Electronic System*, Vol. 34, No. 2 pp. 420-427, April 1988.
- (4) Hong Won-Pyo et al., "Motor Current Signature Analysis for Bearing Damage Detection in Induction Motors", *The Proceeding of ICEMS 2004*, Nov. 1-3, 2004 Jeju Island, Korea.
- (5) R.S. Schoen, and etc. : *Motor Bearing Damage Detection Using Stator Current Monitoring*, *IEEE Tran. on Industry Application*, Vol. 31, No. 6, Nov. 1995.
- (6) W T, Thomson and M, Fenger : *Current Signature Analysis to Detect Induction Motor Faults*, *IEEE Industry Application Magazine*, July/Aug. 2001.

◆ 저자소개 ◆

윤충섭 (尹忠燮)

1979년 연세대학교 기계공학과 졸업. 1981년 연세대학교 대학원 기계공학과 졸업(석사). 1989년 미시간주립대학 전기전자공학과 졸업(박사). 1990~1993년 기계연구원 선임연구원. 현재 한밭대학교 신소재공학부 교수.

홍원표 (洪元杓)

1978년 숭실대학교 전기공학과 졸업. 1989년 서울대학교 대학원 전기공학과 졸업(박사). 1979~1980년 한전 전력연구원 선임연구원. 현재 한밭대학교 건축설비공학과 교수. 당학회 편수이사. 대한설비공학회 에너지 커미셔닝 전문위원.