

A Study on the Development of a Multi-Path Communication Channel Equalizer

Young-Sic Jeong*, Whan-Woo Kim**, Jae-Hong Min*, Wung Park*

*Electronics and Telecommunications Research Institute**

Chungnam National University E-mail: jys@etri.re.kr

ABSTRACT

This paper is a result of the study that develops ghost eliminator which removes ghost among the ghosted analog or digital TV signal.

We proposed innovative multilevel SIGN algorithm which is operated more stable and speedy than conventional LMS or SIGN algorithm. We compared its convergence speed with SIGN algorithm by experiment.

We can eliminate ghost more speedy and stable than conventional method by using the multi-level SIGN algorithm which is presented in this paper. Multi-level SIGN algorithm can be used in any other applications instead of LMS or SIGN algorithm for stability and speed.

1. Introduction

Video or voice signal should be modulated up to appropriate frequency bands for long-distance transmission. If there is only one path, a phenomenon called a ghost does not exist due to multi-path. But, if a radio wave is transmitted, it encounters with various obstacles and is reflected as shown in Fig. 1.1 in most cases. Therefore, it arrives at the receiver as a complex signal which has both time delay and phase error[1].

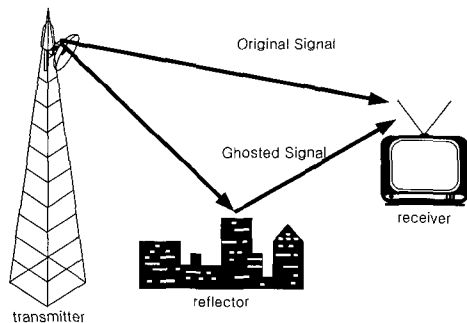

Fig. 1.1 Representation of a ghost generation path.

In an ideal case, a receiver receives the original signal without time delay and phase error, but in actual case, a number of high buildings in a city reflect radio wave, which becomes the main cause of ghost in TV signals. Ghost may occur due to impedance mismatching between the antenna and receiver when we use public antennas or cable TVs. A ghost prior to the main signal is called preghost and the ghost following the main signal is called postghost. It is called quadrature ghost which occurs in the vestigial side band (VSB) modulated signals[2].

A ghost has the same frequency as the main signal and a different phase. Therefore, it is received and demodulated concurrently with the original signal. In a TV receiver, a ghost exists as an overlapped image. In order to eliminate it, a ghosted channel model is established and appropriate digital filters should be applied. In this paper, we use a cascade filter structure of FIR and IIR filters and propose a multilevel SIGN algorithm for fast calculation of filter

*Electronics and Telecommunications Research Institute (jys@etri.re.kr),

** Chungnam National University(wwkim@cnu.ac.kr)

Number of paper : 020438-1009 Issue date : 2002. 10. 9

coefficients and stable operation.

II. Structure of a Ghost Eliminator

A multi-path channel has a finite impulse response. Therefore, a deghosting filter has a IIR filter structure which is the inverse of the channel impose response. It may be unstable when preghost or near ghost which is as large as the main signal exist. To solve this problem, a cascaded structure of FIR and IIR filter is suggested. The FIR filter eliminates the timing error, preghost, and near ghost, and the IIR filter compensates the signal distortion by FIR filtering and eliminates the postghost. Ghosted signal enters the FIR filter first and then goes to the IIR filter after that. If the cascaded structure is implemented using only FIR filters, it is as shown in Fig. 2.1. The internal structure of the FIR filter which is used in Fig. 2.1 is shown in Fig. 2.2. The IIR filter structure which is made by applying the FIR filter of Fig. 2.2 is shown in Fig. 2.3[3]. If we find a parameter by modeling of the channel using the signal from which the timing error, preghost, and near ghost are eliminated[4].

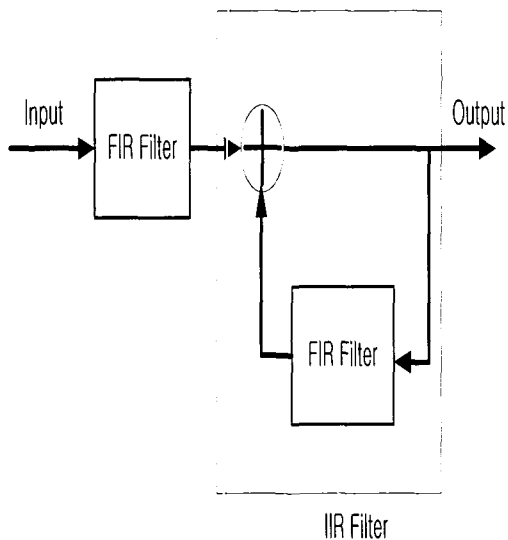

Fig 2.1 Cascaded filter structure of FIR and IIR filters.

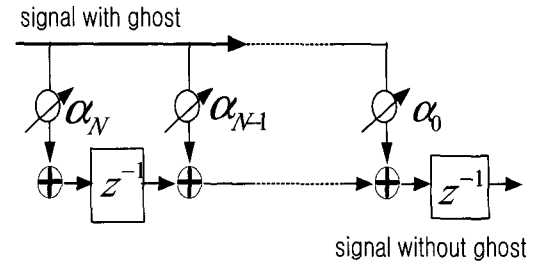

Fig. 2.2 FIR filter to eliminate the preghost and timing error

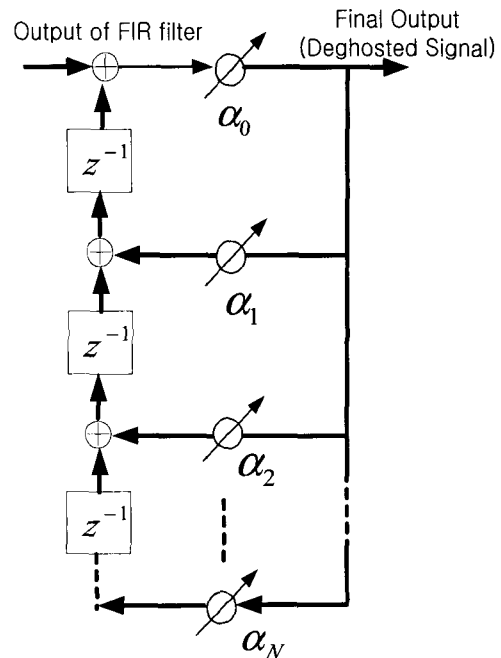

Fig. 2.3 IIR filter structure to eliminate the post ghost

III. Filter Coefficient Calculation Algorithm of Conventional Ghost Eliminator

In order to eliminate a ghost using the ghost eliminator, the hardware filter should have exact filter coefficients given by an appropriate algorithm. The algorithm should have a structure adaptable to the various multi-path channels. A SIGN algorithm is used to find filter coefficients by analyzing the multi-path channel exactly. The channel modeling through SIGN algorithm can

find the ghost parameters[5]. The found time delay and attenuation of ghost are provided to the hardware filter and used to eliminate a ghost[6].

3.1 LMS algorithm

LMS algorithm which is used for the ghost eliminator is a method in which the filter coefficient minimizing the mean square error is found. In this case, the equation to find a filter coefficient is expressed as follows[7]:

$$w_k(n+1) = w_k(n) + 2\mu e(n)x(n-k) \quad (3.1)$$

We need $w_k(n), \mu, e(n)$ and $x(n-k)$ to find a filter coefficient at time $(n+1)$, where $e(n)$ and $x(n-k)$ are determined by time n and index k . Therefore, the constant to determine the speed and accuracy of convergence is μ , which minimizes the mean square error. If we denote the ghosted signal by $x(n)$ and the reference signal by $d(n)$ respectively, the mean square error may be expressed as follows:

$$\begin{aligned} Er &= E[e^2(n+1)] \\ &= E[\{d(n+1) - \hat{d}(n+1)\}^2] \\ &= E\left[\left\{d(n+1) - \sum_{k=-N}^N w_k(n+1)x(n-k+1)\right\}^2\right] \\ &= E\left[\left\{d(n+1) - \sum_{k=-N}^N (w_k(n) + 2\mu e(n)x(n-k))x(n-k+1)\right\}^2\right] \end{aligned} \quad (3.2)$$

If we take a partial differentiation of μ to find the optimal μ , the result is given as follows:

$$\begin{aligned} \frac{\partial E[e^2(n+1)]}{\partial \mu} &= 2E\left[e(n+1)\left\{\sum_{k=-N}^N 2e(n)x(n-k)x(n-k+1)\right\}\right] = 0 \\ &= 2E\left[d(n+1) - \sum_{k=-N}^N \{w_k(n) + 2\mu e(n)x(n-k)\}x(n-k+1)\right] \\ &= E\left[d(n+1) - \sum_{k=-N}^N \{w_k(n)x(n-k+1)\}\right] \end{aligned}$$

$$-2\mu E\left[\sum_{k=-N}^N e(n)x(n-k)\}x(n-k+1)\right] = 0 \quad (3.3)$$

The value μ to minimize the mean square error is given by[8] of

$$\mu_{opt} = \frac{E\left[d(n+1) - \sum_{k=-N}^N w_k(n)x(n-k+1)\right]}{2E\left[\sum_{k=-N}^N e(n)x(n-k)x(n-k+1)\right]} \quad (3.4)$$

The expectation operator E is omitted in real time signal processing since it requires many steps of calculation. Therefore, μ_{opt} may be expressed as follows:[9]

$$\mu_{opt} = \frac{d(n+1) - \sum_{k=-N}^N w_k(n)x(n-k+1)}{2e(n) \sum_{k=-N}^N x(n-k)x(n-k+1)} \quad (3.5)$$

If we suppose that $w_k(n) = w_k(n+1)$ to simplify the equation, Eq. (3.5) can be expressed as follows:

$$\begin{aligned} \mu_{opt} &= \frac{e(n+1)}{2e(n) \sum_{k=-N}^N x(n-k)x(n-k+1)} \\ &\approx \frac{e(n+1)}{2e(n) \sum_{k=-N}^N x^2(n-k)} \end{aligned} \quad (3.6)$$

μ_{opt} is determined by $e(n), e(n+1)$ and the power of signal $x(n)$. μ_{opt} is a constant proportional to $e(n+1)/e(n)$ but inversely proportional to the power of input signal since $e(n) \neq e(n+1)$. The approximation of μ_{opt} which is used for the adaptive signal processing to find an FIR filter coefficient is used in real time signal processing since it takes a long time and

many calculation steps to find μ_{opt} [7].

If the approximation of μ_{opt} is used, the final error is larger than the mean square error when it is converged. If $e(n+1) = e(n)$ in Eq. (3.6), μ_{opt} is expressed as follows:

$$\mu_{opt} = \frac{1}{2 \sum_{k=-N}^N x^2(n-k)} \quad (3.7)$$

We can use μ_{opt} which is inversely proportional to the power of input signal. If the power of input signal $x(n)$ is changed, the error can be converged when μ_{opt} is changed accordingly. However, it is inappropriate to change μ_{opt} according to the power of input signal in the algorithm which requires fast speed since it requires a large number of calculation steps[4]. As shown in Eqs. (3.1) to (3.7), the value of μ_{opt} which is used for the IIR filter of LMS algorithm is expressed in the following Eq. (3.8):

$$\begin{aligned} &= \frac{e(n+1)}{2e(n) \sum_{k=-N}^N d(n-k)d(n-k+1)} \\ &\approx \frac{1}{2 \sum_{k=0}^N d(n-k)d(n-k+1)} \end{aligned} \quad (3.8)$$

A large number of calculation steps are required to find out exact μ_{opt} since μ_{opt} is related to ghosted signal $x(n)$ and saved the ghost canceller reference(GCR) signal[7][8]. Therefore, the error $e[n]$ has a larger value than the mean square error since the approximated value of μ_{opt} is used in LMS algorithm, which is used to find FIR or IIR filter coefficient.

3.2 SIGN Algorithm

The value range of μ_{opt} is restricted in LMS algorithm since it is proportional to the product of $e(n)$ and $x(n-k)$. In order to operate it successfully insensitive to the error, we need an algorithm which is insensitive to some extent to the error. Therefore, the SIGN algorithm which uses the sign of the error instead of the magnitude of error is used. SIGN algorithm uses the sign of the error when it calculates a filter coefficient[9]. The equation for filter coefficient calculation of SIGN algorithm is given as follows:

$$w_k(n+1) = w_k(n) + \mu \text{sign}(e(n))x(n-k) \quad (3.9)$$

SIGN algorithm may have a larger value of μ than LMS algorithm, but the speed of convergence is slower than that of LMS algorithm since the information on the magnitude of error is not used. However, SIGN algorithm is characterized by the fact that it converges because of the fast change of the values of $e(n)$ and $x(n)$ even without the change of the value of μ . SIGN algorithm, which is operated stably in the wide range of input and error, may have a convergence speed which is lower than that of

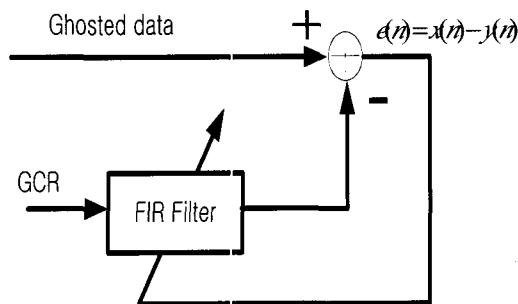

Fig. 3.1 System identification for IIR filter coefficient calculation.

$$\mu_{opt} = \frac{E \left[x(n+1) - \sum_{k=0}^N w_k(n)d(n-k+1) \right]}{2E \left[\sum_{k=0}^N e(n)d(n-k)d(n-k+1) \right]}$$

the LMS algorithm with the optimum μ , but higher than that of the LMS algorithm without the optimum μ [10]. To increase the speed of convergence, we suggest a multilevel SIGN algorithm in the next section.

IV. Multilevel SIGN Algorithm

The speed of SIGN algorithm is lower than that of the LMS algorithm. But, it is operated stably since it uses only the sign of the error. The speed of convergence of LMS algorithm which uses the magnitude of error is higher than that of SIGN algorithm which doesn't use the magnitude of the error. In order to use only the advantage of two methods, We represent multilevel SIGN algorithm. Multilevel SIGN algorithm is more speedy than SIGN algorithm and more stable than LMS algorithm. The filter coefficient adaptation equation of multilevel SIGN algorithm is as follows:

$$w_k(n+1) = w_k(n) + \mu(e(n))x(n-k) \quad (4.1)$$

where $\mu(e(n))$ is given as follows:

If $e(n) \geq 0$,

$$\begin{aligned} \mu(e(n)) &= \mu_1 \text{ if } 0 < e(n) \leq e_1 \\ &= \mu_2 \text{ if } e_1 < e(n) \leq e_2 \\ &= \mu_3 \text{ if } e_2 < e(n) \leq e_3 \end{aligned}$$

If $e(n) < 0$,

$$\begin{aligned} \mu(e(n)) &= -\mu_1 \text{ if } 0 < e(n) \leq e_1 \\ &= -\mu_2 \text{ if } e_1 < e(n) \leq e_2 \\ &= -\mu_3 \text{ if } e_2 < e(n) \leq e_3 \end{aligned}$$

In the above equations, the multilevel SIGN algorithm approaches the LMS algorithm when the step size of multilevel SIGN algorithm becomes smaller. In other words, if the step size of multilevel SIGN algorithm becomes infinitesimally

small, it becomes the LMS algorithm. The convergence characteristic of the proposed multilevel SIGN algorithm is shown in Fig. 6.10 and Fig 6.12.

V. Method of Calculation of Filter Coefficients Using Multilevel SIGN Algorithm

5.1 Understanding of Non-Causal FIR Filter

We find an FIR filter coefficient by comparing the received TV signal with the saved GCR. A filter is non-causal when there is a preghost or sampling error. Therefore, we need a non-causal transversal filter and non-causal filtering is possible by delaying the input sample as many as the preghost range or timing error range. In this case, the final output of the filter is always causal with the input of filter(The casual means that the output doesn't have negative delay of input signal). If a ghosted signal passes through the FIR filter, it becomes a causal signal which can be filtered stably by the IIR filter. A case in which the ghosted input signal is given by Eq. (5.1) will be considered.

$$z(n) = 0.1d(n) + 0.9d(n-1) + 0.3d(n-5) \quad (5.1)$$

In this case, the multi-path channel which generates a ghost is causal but $0.9d(n-1)$ is regarded to be the original signal when it is received by the receiver. Therefore, $0.1d(n)$ is regarded to be the ghost of a non-causally advanced signal of $0.9d(n-1)$, and it is necessary to have non-causal filter to eliminate $0.1d(n)$. However, a ghost eliminator cannot do non-causal filtering since it has to process serially the inputted TV signal. the ghost eliminator delays the entire input signal and does non-causal filtering and maintains causality consequently between the input signal and output signal of the filter. For example, if we delay $x(n)$ by N_p tap, the result is as follows:

$$x(n - N_p) = 0.1d(n - N_p) + 0.9d(n - 1 - N_p) + 0.3d(n - 5 - N_p) \quad (5.2)$$

If $d(n - N_p - 1)$ is $y(n)$, then $x(n - N_p)$ is expressed as follows:

$$x(n - N_p) = 0.1y(n + 1) + 0.9y(n) + 0.3d(n - 4) \quad (5.3)$$

Although $y(n)$ has a non-causal form since $0.1d(n - N_p)$ becomes $0.1y(n + 1)$, it can be eliminated because $y(n)$ is the delayed signal of $0.1d(n)$ as many as N_p . Timing error can be eliminated according to the same principle as described in the above. A non-causal FIR filter which is used in this study can be said non-causal when the main signal is the basis, but the relation between the input signal and output signal is always causal. Furthermore, the output signal is always causal when we put the main signal as the basis, which makes the IIR filter always stable.

VI. Results of Experiments

In this section, it is shown that a quadrature ghost can be eliminated by the multilevel SIGN algorithm and that the convergence speed of multilevel SIGN algorithm is faster than that of sign algorithm. Furthermore, the results of an experiment in which the ghosts are eliminated by multilevel SIGN algorithm from a ghosted signal with preghost and postghost are illustrated.

6.1 Quadrature Ghost Elimination

We knew that a quadrature ghost can be eliminated by the multilevel SIGN algorithm with real number domain processing in an experiment, in which the signal which generates quadrature ghost on GCR signal with Gaussian noise is used. Fig. 6.1 is a GCR which is the approximation of TV vertical synchronizing signal that can be

captured in a broadcasting TV signal. The period of sampling is 70 nsec and 600 samples are used.

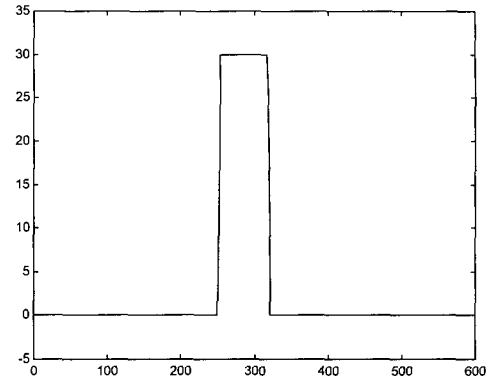

Fig. 6.1 A GCR signal

A quadrature ghost is generated by Hilbert transform of the signal in Fig. 6.1, delayed by 10 samples and multiplied by a constant. To this signal, white Gaussian noise is added and the resulting signal is as shown in Fig. 6.2. In this case, the magnitude of ghost is -13.98 dB, delay time is 700 nsec (10 samples), and variance of noise is -4.4 dB.

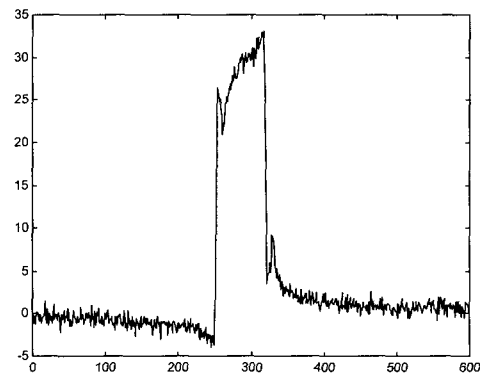

Fig. 6.2 Quadrature ghost and noise added to GCR signal.

Significant distortion occurs at GCR because of the quadrature ghost which is delayed by 10 samples whose magnitude is -13.98 dB. The result of 200 times iteration by multilevel SIGN algorithm is as shown in Fig. 6.3.

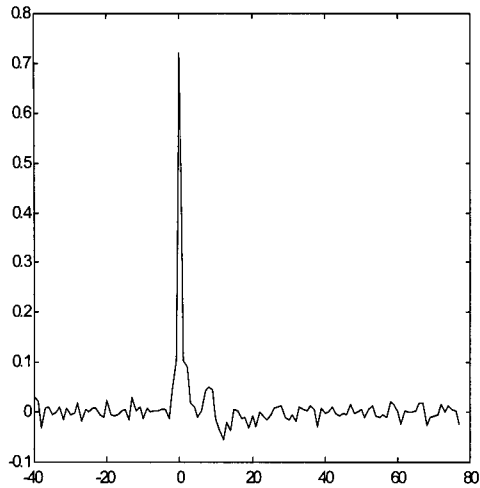

Fig. 6.3 FIR filter coefficients.

The mean square error (MSE) which is decreased with iterations when finding the above FIR coefficient is shown in Fig. 6.4.

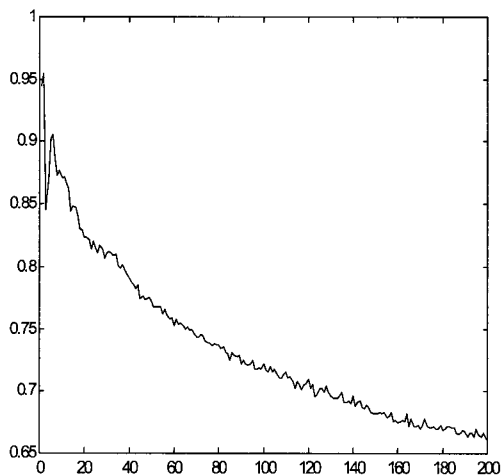

Fig. 6.4 MSE vs. the number of iterations.

We see that MSE is decreased rapidly with the number of iterations. MSE after 200 iterations is 0.67, and if we filter the ghosted signal by FIR filter coefficient at this point, the result is as shown in Fig. 6.5. As can be seen, a large portion of ghost is eliminated by FIR filtering.

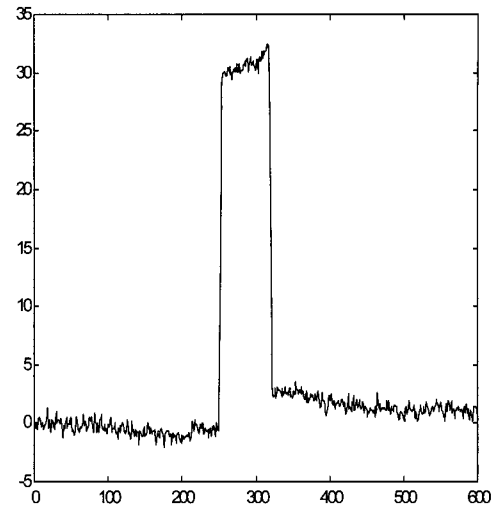

Fig. 6.5 Result after FIR filtering.

IIR filter coefficients are found from the FIR filtered signal. We set $w(0)$ as 1.0 because $w(0)$ should be 1.0 without timing error and the variation of MSE is shown in Fig. 6.6 where we iterate multilevel SIGN algorithm up to 200 times. We see that MSE is decreased with the number of iterations.

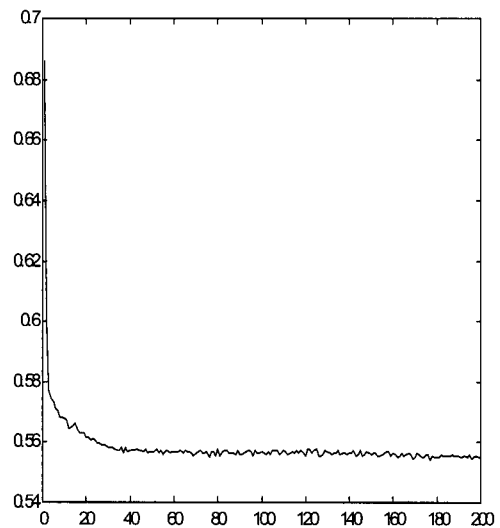

Fig. 6.6 Variation of MSE vs. the number of iteration during IIR filtering.

IIR filter coefficients after 200 iteration are shown in Fig. 6.7.

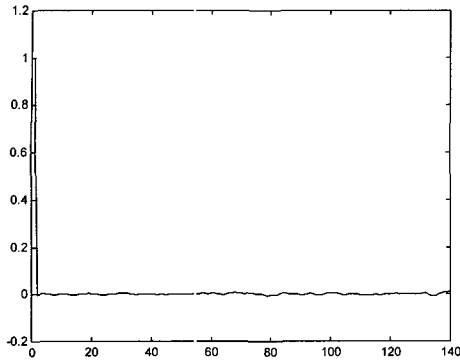

Fig. 6.7 IIR filter coefficients after 200 iterations.

The result of IIR filtering with the FIR filtered signal and IIR filter coefficients are shown in Fig. 6.8. A large portion of quadrature ghost is eliminated and the original signal is retrieved. We verify that the quadrature ghost can be eliminated with processing only in the real number domain.

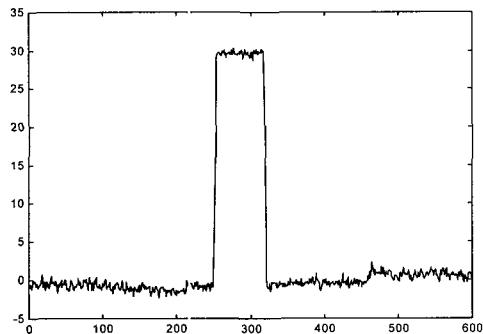

Fig. 6.8 Final output of IIR filter when using FIR filtered signal.

6.2 Comparison of Multilevel SIGN Algorithm with SIGN Algorithm

The multilevel SIGN algorithmic compared to SIGN algorithm in the sense of MSE(Mean Square Error). MSE variation is graphically displayed in two different cases according to iteration of algorithm.

One case, the ghosted signal is expressed as follows.

$$x[n]=d[n]+0.12d[n+10]+0.3d[n-10]+0.1d[n-28]+0.15d[n-110]$$

$x[n]$: ghosted signal

$d[n]$: original signal

This signal is displayed in Fig. 6.9

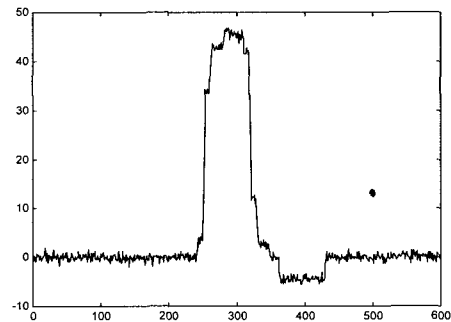

Fig. 6.9 ghosted signal $x[n]$

The result of multi-level SIGN algorithm is compared to SIGN Algorithm in this case.

MSE variation according to the number of iteration is displayed in fig 6.10.

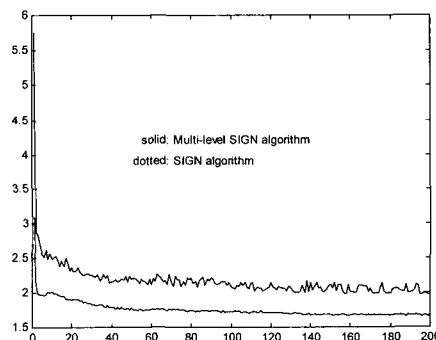

Fig. 6.10 MSE variation according to the number of iteration

Another case, the ghosted signal is expressed as follows.

$$x[n] = d[n] + 0.2d[n-20] + 0.12d[n-38] + 0.1d[n-120]$$

$x[n]$: ghosted signal
 $d[n]$: original signal

This signal is displayed in Fig. 6.11

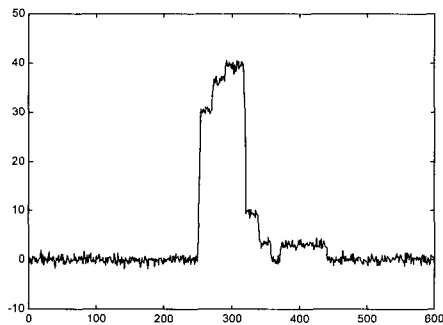

Fig 6.11 ghosted signal $x[n]$

The result of multi-level SIGN algorithm is compared to SIGN Algorithm in this case. MSE variation according to the number of iteration is displayed in fig 6.12.

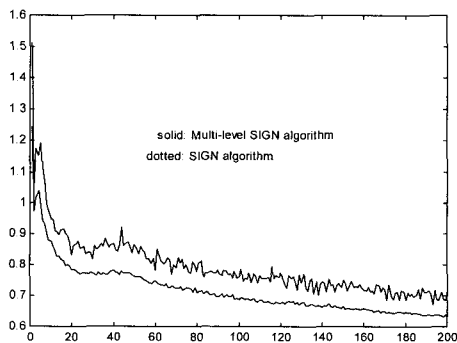

Fig. 6.12 MSE variation according to the number of iteration

In Fig. 6.10 and 6.12, the performance of multilevel SIGN algorithm is compared with that of the SIGN algorithm by comparing the MSE variations in calculation of the FIR filter coefficients. As can be seen in Fig. 6.10 and 6.12

the better performance of multilevel SIGN algorithm is verified.

The multilevel SIGN algorithm proposed in this paper converges faster than the SIGN algorithm by more than three times. The MSE which is obtained by the SIGN algorithm after 200 iterations is the same as that of the multilevel SIGN algorithm after 10 iterations in fig 6.10 and 80 iteration in fig 6.12.

In many other cases, multi-level SIGN algorithm is much faster and stable than SIGN algorithm.

6.3 Elimination of Ghost by Multilevel SIGN Algorithm

In this section, we receive a ghosted signal which has preghost and post-ghost, find FIR filter and IIR coefficient, and eliminate ghost by multilevel SIGN algorithm. The GCR signal uses the sampled signal of the vertical synchronizing signal of TV as shown in Fig. 6.1. In this experiment, the ghosted signal has a -18.41 dB preghost, 10 samples before the main signal, and a -10.46 dB postghost, 10 samples after the main signal and a -16.47 dB postghost, 28 samples after the main signal and -12.04dB postghost, 110 samples after the main signal. If the ghosted signal is $x[n]$, it can be expressed as follows:

$$x[n] = 0.12*d[n-10] + d[n] + 0.3*d[n-10] + 0.1*d[n-28] + 0.25*d[n-110]$$

This signal is displayed in Fig. 6.13.

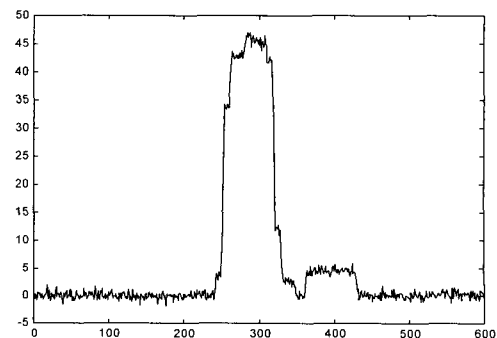

Fig. 6.13 Ghosted signal.

The FIR filter coefficients are the same as those shown in Fig. 6.14 in the multilevel SIGN algorithm.

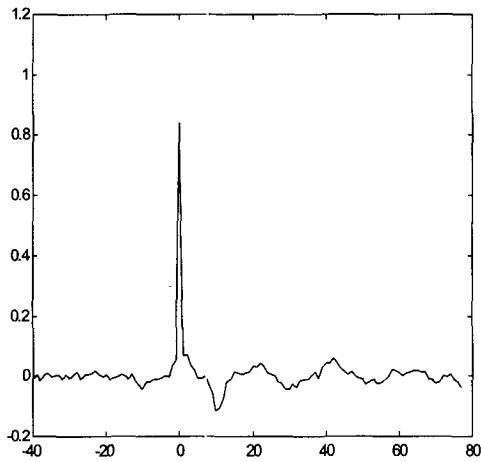

Fig. 6.14 FIR filter coefficients

The 118 FIR filter coefficients are calculated and the result $c[n]$ of FIR filtering using the FIR filter coefficients is shown in Fig. 6.15.

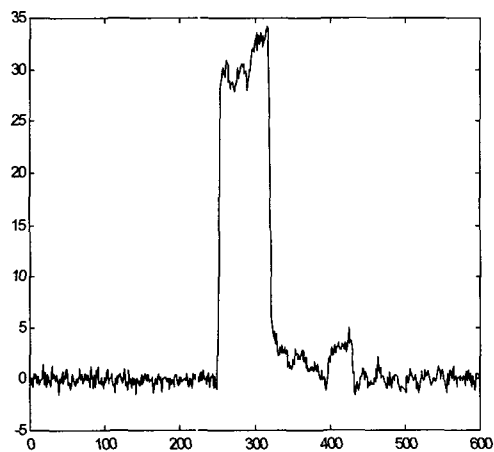

Fig. 6.15 Result of FIR filtering.

The IIR filter coefficients are found using the signal $c[n]$ which is filtered by the FIR filter, the result of which is shown in Fig. 6.16.

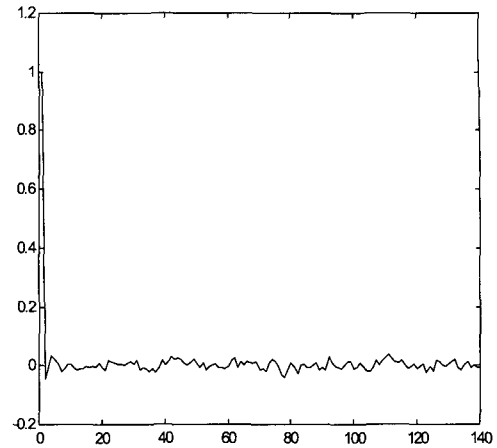

Fig. 6.16 IIR filter coefficients.

140 IIR filter coefficients exist because we find the filter coefficients using the signal which is FIR filtered. The IIR filter compensates for the distortion resulted by FIR filtering. The result of IIR filtering of the FIR filtered signal is shown in Fig. 6.17.

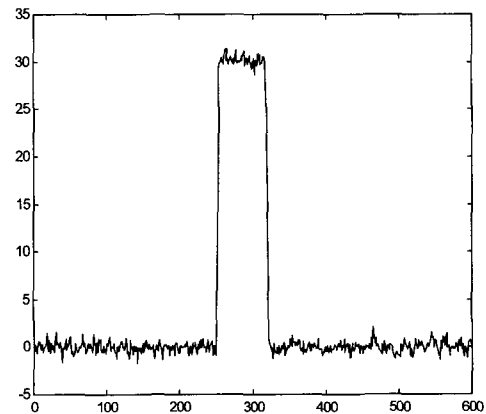

Fig. 6.17 Result of IIR filtering.

As can be seen in Fig. 6.17, the preghost and postghost are mostly eliminated. The multilevel SIGN algorithm is especially powerful when we are unable to estimate the magnitude difference between the ghosted signal and original signal, and in addition, it converges faster than the SIGN algorithm and hardly diverges.

VII. Conclusions

In this paper, we present the hardware structure of a ghost eliminator and a new multilevel SIGN algorithm which analyzes channels fast and stably. It is proved by simulation that multi-level SIGN algorithm is well functioning at various ghost and faster than SIGN algorithm. The multilevel SIGN algorithm can be used in any other applications for speed and stability instead of LMS or SIGN algorithm.

We adopted a cascaded filter structure that has an FIR filter in the front and an IIR filter in the rear part. In order to eliminate a moving ghost, it is necessary to speed up the convergence of an algorithm which analyzes the multi-path communication channels.

REFERENCES

- [1] R.K. Jugen, Good-by TV ghost, IEEE SPECTRUM, pp. 50-52, Jul. 1992.
- [2] B. Grab, Basic Television and Video System, 5th ed, Macgraw-HILL, 1984.
- [3] TZY-Hong S. Chao, Multi-Path Equalization for NTSC Video By using Digital IIR Filter, IEEE Trans. Consumer Electronics, Vol. 34, No. 1, pp. 268-278, Feb. 1998.
- [4] W. Ciciora, G. Sgrignoli, and W. Thomas, A Tutorial on Ghost canceling in television system, IEEE Trans. Consumer Electronics, Vol. CE-25, Feb. 1979.
- [5] V.J. Mathews and S.H. Cho, Performance Analysis of Adaptive Filters Equipped with the Dual Sign Algorithm, IEEE Trans SIGNAL PROCESSING, Vol. 39, No. 1, pp. 85-91, Jan. 1991.
- [6] Salvador Olmos and Pable Laguna, Steady-State MSE Convergence of LMS Adaptive Filters with Deterministic Reference Inputs with Applications to Biomedical Signal, Trans. On Signal Processing. Bol. 48, No. 8, pp. 2229-2240, August 2000.

- [7] Wee-Peng Ang, A New Class of Gradient Adaptive Step-Size LMS Algorithms, IEEE Trans. On Signal Processing, Vol. 49, No. 4, pp. 805-809, April 2001.
- [8] Macrcio H. Costa, Stochastic Analysis of the LMS Algorithm with a Saturation Nonlinearity Following the Adaptive Filter Output, IEEE Trans. On Signal Processing, Vol. 49, No. 7, pp. 1370-1387, July 2001.
- [9] E. Eweda, Optimum Step Size of Sign Algorithm for Nonstationary Adaptive Filtering, IEEE Trans. ACOUSTICS SPEECH AND SIGNAL PROCESSING, Vol. 38, No. 11, pp 1897-1901, Nov. 1990.
- [10] W.A. Serthares, Adaptive Algorithms with Nonlinear Data and Error Functions, IEEE Trans. Signal Processing, Vol. 40, No. 9, pp. 2199-2206, Sep. 1992.

정영식(Young-Sic Jeong)

정회원



1991년 2월 : 영남대학교 전자공학과 졸업
1993년 2월 : 포항공과대학교 전자전기공학과 석사
2000년 3월~현재 : 한국전자통신연구원 선임연구원

<관심분야> 변호이동성, 통신공학, 신호처리

김환우(Whan-Woo Kim)

정회원



1977년2월: 서울대학교 전자공학과 학사
1979년2월: 한국과학기술원 전기 및 전자공학과 석사
1988년6월: University of Utah 전자공학과 박사
1980년6월 ~현재 충남대학교 전기정보통신공학부 교수

<관심분야> 초고속 디지털 통신, 디지털 신호처리, binary CDMA

민 재 홍(Jae-Hong Min)



1978년2월 고려대학교
산업공학과
1990년8월 고려대학교
경영대학원 석사
2001년2월 고려대학교 전산학
과 박사수료
1978년3월~현재 한국전자통신
연구원 팀장(책임연구원)

<관심분야> 무선인터넷, 통신공학

박 응(Wung Park)

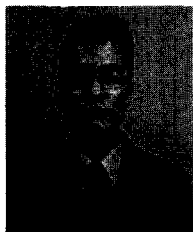

1999년2월 한양대학교
경제학
2001년2월 고려대학교
대학원 경제학 석사
2001년1월~ 현재 한국전자통
신 연구원 연구원

<관심분야> 통신제도, 국제표준화