

Photophysical and Photochemical Property of ATX-S10

Toshiaki Ito^{1*}, Shigetoshi Okazaki¹, Kazumi Kageyama¹, Toru Hirohata¹, Eiji Kohno² and Toru Hirano²

¹Hamamatsu Photonics K.K., Hamakita 434-8601, Japan

²Photon Medical Research Center, Hamamatsu University School of Medicine, Hamamatsu 431-3192, Japan

Photodynamic therapy (PDT) is a medical treatment using laser and photosensitizing drug taken up to destroy cancer cells. Singlet oxygen (¹O₂) generation is strongly related to this treatment. We have built a direct detection system monitoring feeble luminescence, in the near IR region, from ¹O₂. We have comparatively studied the photophysical and photochemical properties in solution of a newly developed drug ATX-S10 and Photofrin already investigated clinically. We demonstrated that ATX-S10 was capable of efficiently yielding ¹O₂, which may lead to highly efficient PDT treatment. Successive laser excitation photobleached ATX-S10 readily in a dose-dependent manner. This result shows that ATX-S10 is useful in setting up suitable medical treatment conditions to minimize side effects.

Key words : photodynamic therapy (PDT), singlet oxygen, near IR photodetector, photon-counting, photobleaching

INTRODUCTION

Photodynamic Therapy (PDT) is a minimally invasive modality for treating cancer and other conditions [1,2]. After intravenous injection of a PDT drug as a photosensitizer, the drug is selectively retained by the tumor cells. After a certain period of time the tumor becomes more sensitive than the adjacent normal tissues. When such PDT drug is activated by laser, the tumor is more likely to be killed by cytotoxic agents. The main cytotoxic agent in PDT is widely believed to be singlet oxygen (¹O₂), a highly reactive oxygen species that oxidizes various biological substrates. ¹O₂ is believed to be a major mediator of photodynamic damage in biological systems. In PDT, ¹O₂ is produced via the following Type-II photochemical pathway [3]:

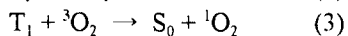
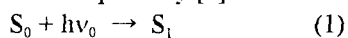

where S₀, S₁, T₁ are the photosensitizer ground state, the first excited singlet state and the first excited triplet state, respectively; ³O₂ and ¹O₂, the ground-state triplet and the excited singlet states of oxygen, respectively.

Therefore, ¹O₂ is strongly related to PDT, and monitoring ¹O₂ generation is important in PDT drug

development. Once produced, ¹O₂ molecules can either undergo oxidization of surrounding biomolecules or undergo radiative decay at around 1270 nm [3]. However, it is extremely feeble, and since there were no suitable photo-detectors in this wavelength region, satisfying ¹O₂ detection was not performed until now.

In recent years, HAMAMATSU succeeded in producing a new type of near IR photomultiplier (NIR-PMT) using a semiconductor photocathode. This NIR-PMT enables to extend the sensitivity region up to 1400 nm or 1700 nm, and has high-speed response as well as photon-counting measurement capability [3-5]. Furthermore, a near IR image intensifier (NIR-II) has also been developed with this photocathode. By using these detectors, we have studied comparatively the photophysical and photochemical properties of newly developed PDT drug ATX-S10 [6,7] and the already investigated Photofrin [1]. ATX-S10, a hydrophilic chlorin photosensitizer is thought to be a candidate for the second-generation PDT photosensitizer. Also we have studied the relation of ¹O₂ generation to photobleaching from the viewpoint of a practical application.

MATERIALS AND METHODS

ATX-S10 was provided by Photochemical Company, and Photofrin was purchased from Wyeth Lederle (Japan)

*To whom correspondence should be addressed.
E-mail : toshiaki@crl.hpk.co.jp

Ltd. All experiments were performed in phosphate buffer saline (PBS) solution (pH7.4) at room temperature under aerated conditions. Absorption spectra were recorded with a spectrophotometer (U3500 HITACHI).

Fig. 1 shows the experimental setup for observing $^1\text{O}_2$ luminescence. A quartz cuvette (3 x 10 x 40 mm) was used as the irradiation cell. Exciting light source was an optical parametric oscillated laser system (OPO L5996, HAMAMATSU). Time-resolved $^1\text{O}_2$ emissions were detected by a near IR photomultiplier (NIR-PMT R5509-42, HAMAMATSU) and a multi-channel scaler (SR430, Stanford Research Systems). $^1\text{O}_2$ emission spectra were detected by the gated photon-counting with a CCD multi-channel detector combined with a near IR image intensifier (NIR-II, HAMAMATSU).

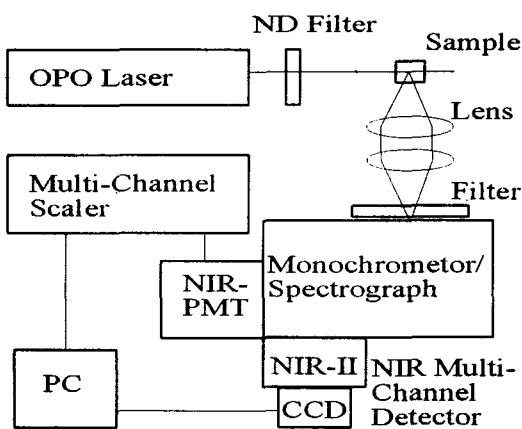

Fig. 1 Experimental setup used for the detection of $^1\text{O}_2$ luminescence.

RESULTS AND DISCUSSION

Absorption spectra. Absorption spectra of the PDT drugs in PBS are shown in Fig.2. The excitation wavelength used in our following experiment for ATX-S10 is 665 nm (right arrow) and that for Photofrin is 630 nm (left arrow), respectively. Fig.2 shows that ATX-S10 has an intense absorption at wavelength greater than 650 nm. The increased absorbance in the red region of the spectrum and the increased molecular absorption coefficients give rise to more excited photosensitizer at deeper tissue sites and hence more suitable for therapeutic purposes.

Time profile of $^1\text{O}_2$ emission. Fig.3 shows decay curves of $^1\text{O}_2$ luminescence observed by NIR-PMT and multi-channel scaler. Both curves have decay time of several micro seconds. Therefore we decided to set a gate time of 0.5 – 5.5 μs in later experiments.

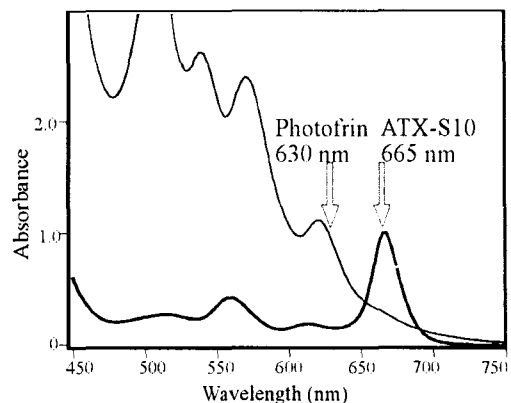

Fig.2 Absorption spectra of the PDT drugs.

Concentration ;
ATX-S10 : 50 mg/kg,
Photofrin : 410 mg/kg in PBS.

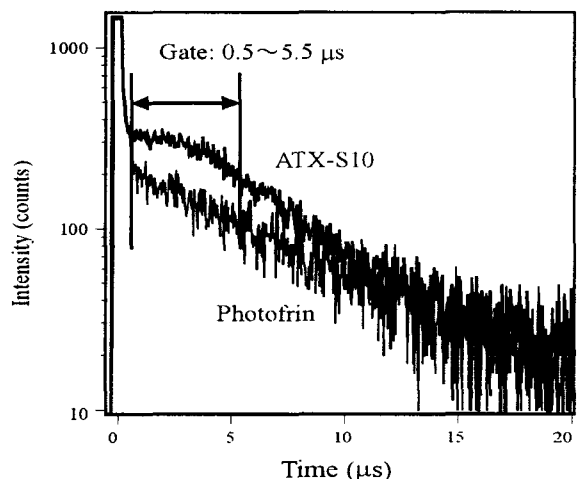

Fig.3 Decay curves of 1270 nm emission signal from the PDT drugs in PBS.

Concentration : 50 mg/kg
Excitation wavelength : 665 nm for ATX-S10, 630 nm for Photofrin
Laser power : 3 mW/cm
Collection times : 250 s

The yield of $^1\text{O}_2$ generation. The yields of $^1\text{O}_2$ generation in ATX-S10 and Photofrin were compared under identical emission intensity of $^1\text{O}_2$, by providing the same excitation energy and the same absorbance (shown in Fig.2) at each wavelength. Fig.4 shows the emission spectra of $^1\text{O}_2$ from each drug in PBS, which was measured with an NIR multi-channel detector. Under the conditions in Fig.4, an identical amount of excited molecules of those drugs must have been generated. From the amount of those excited drug molecules, it is possible to estimate the amount of $^1\text{O}_2$ generated. In Fig.4, ATX-S10 had emission intensity

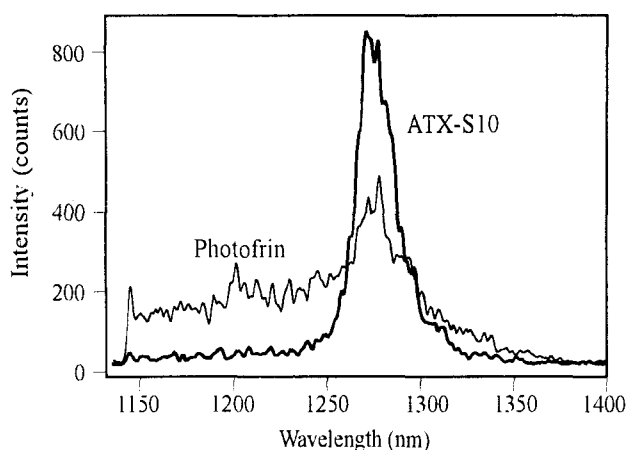

Fig.4 Emission spectra of 1O_2 from the PDT drugs.

Laser intensity : 10 mW , duration : 20 Hz
Collection times : 5 min.

3 – 4 times higher than Photofrin. We can understand that the yield of 1O_2 generation of ATX-S10 is better.

Quantity of 1O_2 generation and photobleaching. We examined the efficiency of 1O_2 generation in the same concentration (10 mg/kg). Also photobleaching effect was observed. Fig.5 shows that temporal variety of the emission intensity of 1O_2 generated from both drugs. The horizontal axis indicates not only the time scale but also the

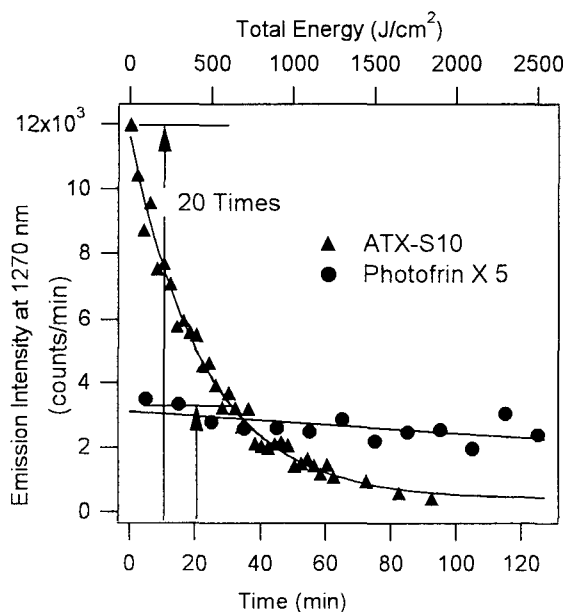

Fig.5 The decay of the emission intensity of 1O_2 from the PDT drugs in PBS under continuous laser irradiation.

quantity of light that excited them (the upper scale). The initial emission intensity of 1O_2 by ATX-S10 is 20 times higher than that by Photofrin. Along with the successive laser irradiation, the emission intensity of 1O_2 was gradually reduced. When we examined absorption spectra in series of this experiment, the absorption in the visible region became reduced. This indicates that photobleaching occurred through this experiment, especially for ATX-S10. We confirmed that the rate of 1O_2 emission was proportional to the absorption at the excited wavelength. This result is useful in setting up suitable medical treatment conditions for minimizing side effects.

Finally, in *in vivo* measurements, the same results as the case of this solution system were obtained. We believe it will be important in future clinical applications as well as in evaluating PDT drugs, e.g., finding suitable conditions of the PDT medical treatment.

REFERENCES

1. McCaughan, J. S. Jr. (1999) Photodynamic therapy a review. *Drugs Aging* 15, 49-68.
2. Damoiseau, X., H. J. Schuitmaker, J. W. M. Lagerberg and M. Hoebeke (2001) Increase of the photosensitizing efficiency of the Bacteriochlorin *a* by liposome-incorporation. *J. Photochem. Photobiol. B: Biol.* 60, 50-60.
3. Niedre, M., M. S. Patterson and B. C. Wilson (2002) Direct near-infrared luminescence detection of singlet oxygen generated by photodynamic therapy in cell *in vitro* and tissues *in vivo*. *Photochem. Photobiol.* 75, 382-391.
4. Niigaki, M., T. Hirohata, T. Suzuki, H. Kan and T. Hiruma (1997) Field-assisted photoemission from InP/InGaAsP photocathode with *p/n* junction. *Appl. Phys. Lett.* 71, 2493-2495.
5. Shimizu, O., J. Watanabe and K. Inakubo (1997) Photon-counting technique facilitates both time- and spectral-resolved measurements of near-IR emission of singlet oxygen $O_2(^1\Delta_g)$ in aqueous solution. *J. Phys. Soc. Jpn.* 66, 268-269.
6. Nakajima, S., I. Sakata, T. Hirano and T. Takemura. (1998) Therapeutic effect of interstitial photodynamic therapy using ATX-S10(Na) and a diode laser on radio-resistant SCCVII tumors of C3H/He mice. *Anticancer Drugs* 9, 539-543.
7. Obana, A., Y. Gohto, K. Kaneda, S. Nakajima, T. Takemura and T. Miki (1999) Selective occlusion of choroidal neovascularization by photodynamic therapy with a water-soluble photosensitizer, ATX-S10. *Lasers Surg. Med.* 24, 209-222.