

## **Adsorption and Desorption Characteristics of Methyl Iodide on Silver Ion-Exchanged Synthetic Zeolite at High Temperature**

**Geun Il Park, Byung Sun Choi, Il Hoon Cho, and Joon Hyung Kim**

Korea Atomic Energy Research Institute  
150 Dukjin-dong, Yusong-gu, Taejon 305-353, Korea  
ngipark@kaeri.re.kr

**Seung Kon Ryu**

Dept. of Chemical Engineering, Chungnam National University,  
220 Kungdong, Yusung, Taejon 305-764, Korea.

(Received March 21, 2000)

### **Abstract**

The adsorption characteristics of methyl iodide generated from the simulated off-gas stream on various adsorbents such as silver ion-exchanged zeolite (AgX), zeocarbon and activated carbon were investigated. An extensive evaluation was made on the optimal silver ion-exchanged level for the effective removal of methyl iodide at temperature up to 380°C. The degree of adsorption efficiency of methyl iodide on silver ion-exchanged zeolite is strongly dependent of silver ion-amount and process temperature. The influence of temperature, methyl iodide concentration and silver ion-exchanged level on the adsorption efficiency is closely related to the pore characteristics of adsorbents. It would be facts that the effective silver ion-exchanged level was about 10 wt%, based on the degree of silver utilization for the removal of methyl iodide.

**Key Words** : methyl iodide, adsorption, desorption, silver, zeolite, zeocarbon

### **1. Introduction**

During the irradiation of nuclear fuel in nuclear power plants, various hazardous radionuclides are generated. In connection with the health and environmental impacts, specially, the prevention of the release of these radioactive materials to the environment has become a very important issue in

nuclear-waste R&D program. Among these radioactive wastes, it is widely recognized that radioiodines such as elemental iodines ( $I$ ,  $I_2$ ), organic iodide ( $CH_3I$ ) and hypoiodous acid ( $HOI$ ) are the most important nuclides due to their volatility and the significant radiological effects on the human body and environment [1,2]. Controlling the release of these species depends

on the design of the off-gas treatment and ventilation systems within each particular process of nuclear power plant and also on the reactor type.

The removal of radioiodines from the gaseous effluents of nuclear power plant has generally been performed using activated carbon [3-6]. Specifically, the technology for the retention of radioiodine has been improved by the impregnation of activated carbon [3-5]. Tertiary amine-exchanged carbons have been originally developed for the control of various halide-type toxic gases to form the stable quaternary salts on the surface of activated carbon [5]. Their use to adsorb the organic radioactive halides, especially  $\text{CH}_3\text{I}$ , has been introduced by Collins et al. [6]. Among these halide complexing amines, TEDA (TriEthylene DiAmine) is widely used in the world for nuclear facility air cleaning [4].

During the past several decades, adsorption characteristics of carbon adsorbents such as KI or TEDA-impregnated activated carbons have been widely studied. Although activated carbon has been successfully used in power plant, activated carbon cannot be considered as a primary sorbents at high temperature systems, because of its low ignition temperature and its adverse reaction with nitrogen oxide [5]. These factors virtually rule out the use of this material at high temperature systems like DUPIC (Direct Use of Spent PWR Fuel In CANDU Reactor) process. As a result, the promising approach to the problem of iodine removal under high temperature conditions is to use inorganic adsorbents on which a stable iodine compound is formed. Numerous studies for the removal of radioiodine from off-gas stream of nuclear facilities have been performed with various silver ion-exchanged inorganic adsorbents [7-11]. These systems in which adsorbents function as primary filtering of radioiodine have some advantages in their simplicity and smaller amounts

of secondary radioactive wastes in comparing with wet processes. Although a number of studies have been conducted to evaluate the loading of both elemental and methyl iodide on silver ion-exchanged zeolite at high temperature, these studies focused primarily on the scale-up of deep-bed during evaluation of the material under a broad range of process conditions and contaminants for total bed loading at the time of breakthrough. A few studies have evaluated the equilibrium and maximum-loading capacities of silver ion-exchanged zeolite [7-13]. In our laboratory, preliminary performance tests for the removal of methyl iodide by various silver ion-exchanged adsorbents had already been carried out [14]. On reviewing previous studies, it was reported that the removal capacities of methyl iodide on silver ion-exchanged zeolites at high temperature ranges were mainly dependent on bed depth or temperature [8-12]. These results would be contributed to chemical reaction and diffusion in adsorbent. Therefore, more detailed studies are needed to establish a silver utilization for the removal of radioiodine as a function of process temperature. Methyl iodide was chosen as representative of organic iodides existed in containment of power reactor and the nuclear facilities, because methyl iodide is considered to be one of the most difficult species among organic iodides, compared to elemental iodine [16].

The purpose of this paper is to evaluate the adsorption characteristics of gaseous methyl iodide on the various adsorbents including silver ion-exchanged zeolite at high temperature up to 400 °C. In this approach, the influence of impurities such as water vapor or nitrous oxide was not considered, because these compounds are not considered in DUPIC (Direct Use of Spent PWR Fuel in CANDU Reactors) process. The comparison of adsorption capacities for various adsorbents was carried out, based on the

**Table 1. Physical Properties of Various Base Adsorbents**

Adsorbents	13X	Zeocarbon (ZC)	Activated Carbon (AC)
Average Pore Diameter, Å	24.5	13.3	11.9
Surface Area, m <sup>2</sup> /kg,	7.99 × 10 <sup>5</sup>	8.20 × 10 <sup>5</sup>	1.42 × 10 <sup>6</sup>
Total Pore Volume, m <sup>3</sup> /kg	3.56 × 10 <sup>-4</sup>	3.82 × 10 <sup>-4</sup>	5.14 × 10 <sup>-4</sup>
Micropore Volume, m <sup>3</sup> /kg	2.37 × 10 <sup>-4</sup>	2.15 × 10 <sup>-4</sup>	4.25 × 10 <sup>-4</sup>

**Table 2. Physical Properties of Silver Ion-Exchanged Zeolite**

Adsorbents	NaX (13X)	AgX-10wt% (AgX-10)	AgX-20wt% (AgX-20)	AgX-30wt% (AgX-30)
Pore Size, Å	24.5	24.4	23.4	23.6
Surface Area, m <sup>2</sup> /kg	7.99 × 10 <sup>5</sup>	7.95 × 10 <sup>5</sup>	7.2 × 10 <sup>5</sup>	6.99 × 10 <sup>5</sup>
Total Pore Volume, m <sup>3</sup> /kg	3.56 × 10 <sup>-4</sup>	3.22 × 10 <sup>-4</sup>	2.88 × 10 <sup>-4</sup>	2.81 × 10 <sup>-4</sup>
Micropore Volume, m <sup>3</sup> /kg	2.37 × 10 <sup>-4</sup>	2.05 × 10 <sup>-4</sup>	1.92 × 10 <sup>-4</sup>	1.83 × 10 <sup>-4</sup>

saturation of adsorption capacity in all experimental tests. Major parameters affecting adsorption characteristics are the process temperature and silver ion-exchanged amount. From the standpoint of silver utilization for the removal of methyl iodide, both the optimal operating temperature and the effective silver ion-exchanged level were determined.

## 2. Experimental

### 2.1. Materials

The sodium form zeolite(NaX) of 8~16 mesh of Linde Molecular Sieves 13X(Supplied by Aldrich Co., USA) was used to prepare a silver ion-exchanged zeolite, **namely AgX**. As an preliminary experiment to compare the adsorption capacity of other adsorbents, zeocarbon(ZC) of 2~3 mm sphere (ZEOBUILDER Co., KOREA) and activated carbon of 8~16 mesh granule (Supplied by SAM CHUL RI Co.,KOREA) were also selected. Zeocarbon is composed of activated carbon (40 wt%) and zeolite 5A (60 wt%). Table 1

shows the results of BET-N<sub>2</sub> analysis (Micromeritics, ASAP 2400) for various base adsorbents.

### 2.2. Preparation of Silver Ion-exchanged Zeolite

The silver ion-exchanged zeolite was prepared through ion exchange method in a batch reactor. Zeolite was purged with a water-saturated air stream at room temperature for three days to equilibrate it with moisture, which prevents bead fissure of the 13X on soaking in water. After these treatments, zeolite was washed with distilled water to remove fines. Silver ion-exchange on 13X was carried out with silver nitrite (AgNO<sub>3</sub>) solution of 1.2 N for 8 hours at room temperature, and then washed with distilled water to remove the excess salt ions. The AgX was dried to obtain a constant weight in a vacuum oven at 180 °C for 24 hours. Then, silver ion-exchanged amount of each AgX was obtained by weight gains from initial weight of 13X. The physical properties of AgX measured

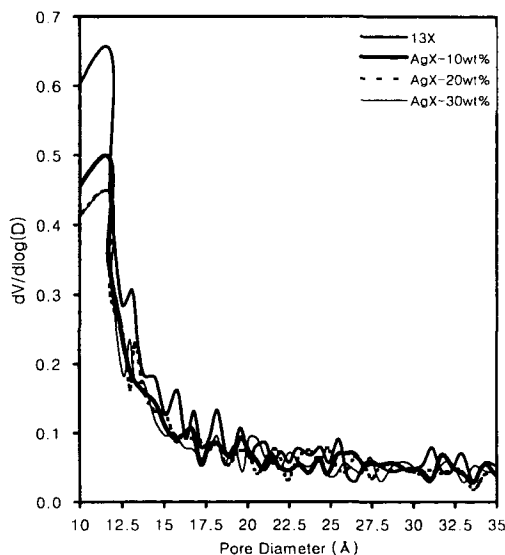

**Fig. 1. Pore Size Distributions of Various Silver Ion-exchanged Zeolites**

by BET-N<sub>2</sub> analysis are listed in Table 2. Fig. 1 shows the pore size distribution of various AgX. Silver ions are included within the pore structure of the zeolite as isolated Ag<sup>+</sup> ions. It is reported that from the results of XANES (X-ray Absorption Near Edge Structure) and DRS (Diffuse Reflectance Spectrum) measurement, silver ion are anchored onto the inner surfaces of the micropores of the zeolite in a high dispersion state without the formation of any large clusters or crystals of the Ag metals or oxides.

Surface area of AgX decrease as silver ion-exchanged amount increase. This would mainly be attributed to the blocking of micropore, as shown in Fig. 2.

### 2.3. Adsorption and Desorption Tests

The schematic diagram of experimental apparatus was shown in Fig. 3. Gaseous methyl iodide is produced from an evaporation of aqueous methyl iodide. Gas-phase concentration is

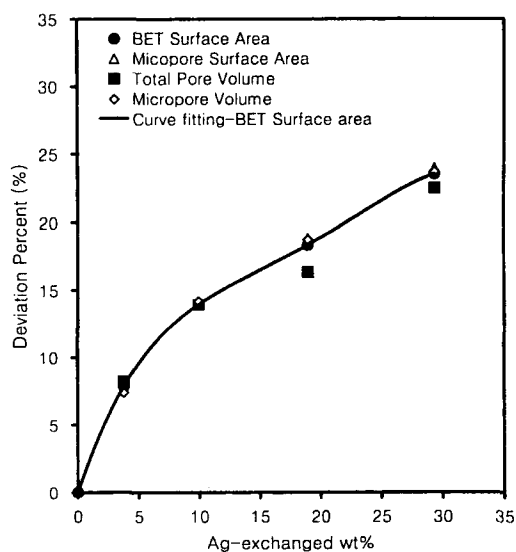

**Fig. 2. Deviation of Pore Characteristics with Increasing Silver Ion-exchanged Level Compared to 13X**

adjusted by controlling the solution temperature and the nitrogen flow rate to methyl iodide generators. Dry air was used as a carrier gas at 4 l/min, linear velocity of 0.18 m/sec. All parts of the system, such as adsorption column, mixing baffle and gas flow lines, were made of glass and pyrex to prevent the elemental iodine plate-out and methyl iodide trapping. Temperature inside adsorbent was controlled up to 400 °C by heating the column in electric furnace. Constant amount of adsorbents is packed in a column with a dimension of 0.022 m I.D. by 0.6 m length, and these adsorbents are thermally equilibrated with gaseous-phase. Effluent concentration of methyl iodide from the column was analyzed by the gas chromatography with a pulse discharged detector (PDD) and GS-Q capillary column at oven temperature of 140 °C. Both the breakthrough curve of methyl iodide adsorption and the weight change of adsorbent were used to obtain the adsorption amount of adsorbate.

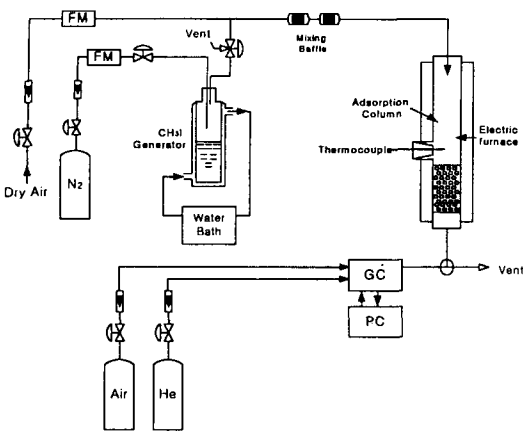
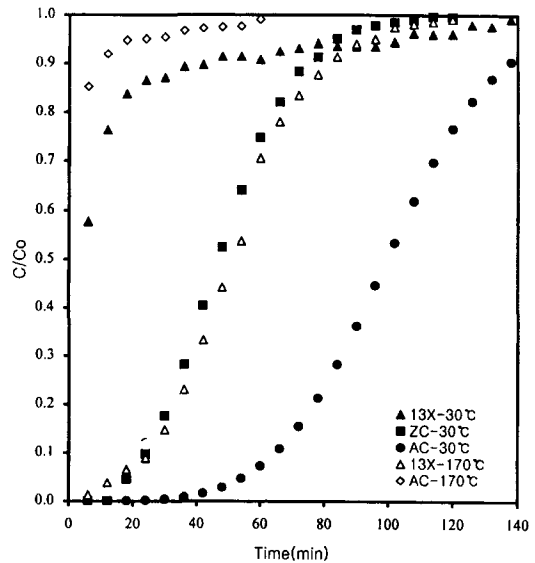

**Fig. 3. Schematic Diagram of Apparatus for Methyl Iodide Adsorption Under High Temperature Condition**

### 3. Results and Discussion

#### 3.1. Adsorption Capacities of Various Base Adsorbents

In order to compare the adsorption capacities of methyl iodide on three kinds of base adsorbents, such as activated carbon, zeocarbon and 13X, preliminary tests were carried out at constant test conditions, as mentioned in experimental section. The breakthrough curves of methyl iodide adsorption using various adsorbents both at 30°C and 170°C were compared in Fig. 4. Equilibrium adsorption amounts of methyl iodide for three base materials up to 380°C were summarized in Fig. 5. It indicates that activated carbon has an excellent adsorption capacity at 30°C compared to the others. However, the adsorption capacity of activated carbon markedly decreases with increasing temperature. On the other hand, 13X showed the higher adsorption capacity of methyl iodide than the activated carbon as the temperature increases. Zeocarbon shows a similar



**Fig. 4. Breakthrough Curves of Methyl Iodide Adsorption on Various Base Adsorbents at 30°C and 170°C**

adsorption pattern of activated carbon at higher temperature range, which implies that no synergistic effect due to the mixing of two materials has observed in adsorption capacity. Low adsorption capacities on both activated carbon and zeocarbon at high temperature would be caused by higher desorption rate than adsorption rate. As reported in previous investigation [15], this result would be another evidence that activated carbon has a poor methyl iodide retention at a high temperature range compared to zeolite 13X.

In contrary to activated carbon and zeocarbon, an increase in the adsorption capacity of methyl iodide on 13X at a higher temperature up to 380°C is due to both physisorption and chemisorption occurred in the zeolite matrix. Test on maximum capacities performed by Thomas [9] indicated that both physisorption and chemisorption occurred in the zeolite. The adsorbent was saturated by

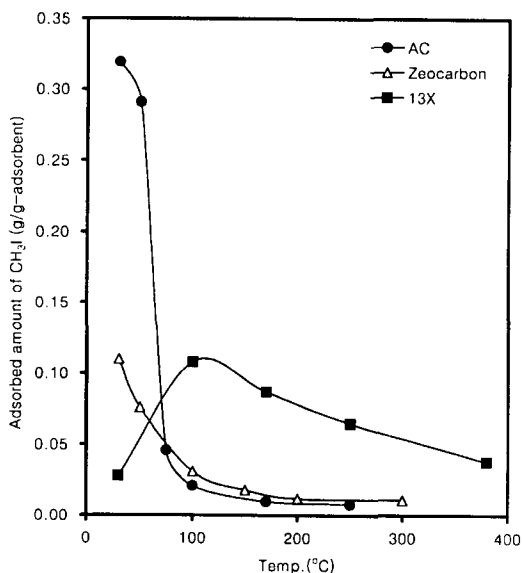

**Fig. 5. Adsorption Amounts of Methyl Iodide on Various Adsorbents with Increasing Adsorption Temperature**

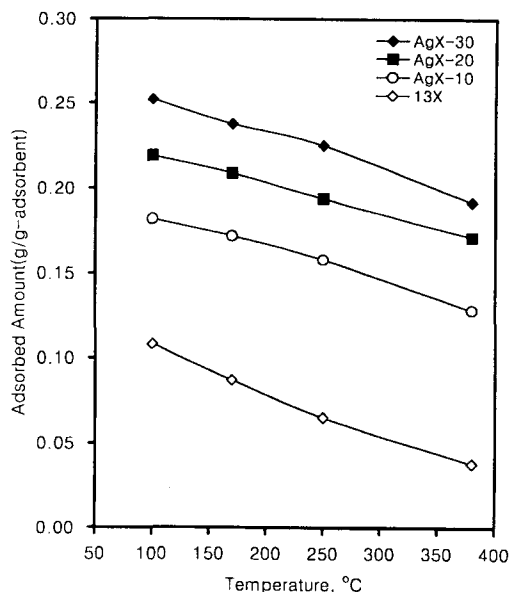

**Fig. 6. Variation in Total Adsorption Amounts of Methyl Iodide on Various AgX with Increasing Adsorption Temperature**

exposure to gaseous iodine using a face velocity of 1 cm/sec and a bed temperature of 150°C until constant weight was obtained. Adsorbent was then purged with air until the rate of iodine desorption was negligible. The remaining iodine was considered chemisorption to be observed 30mg I<sub>2</sub>/g 13X. It also indicated that the chemisorptive bonds formed are not metal iodide bonds although bonding may be occurring near the metal sites [17].

**3.2. Adsorption and Desorption Characteristics of Methyl Iodide on AgX**

Adsorption and desorption characteristics of methyl iodide on the various AgX were evaluated as the function of adsorption temperature and silver ion-exchanged amount. All tests were performed under the same experimental conditions, including input concentration and face velocity.

Fig. 6 shows variations in total adsorption amounts with ranges of 100°C to 380°C on each AgX, respectively. It is observed that adsorption capacity on each AgX is proportionally decreased as temperature increases. The reduction of adsorbed amount appeared to be about 20% with an increase to 380°C from 170°C.

The effect of temperature on iodine loading by AgX is not completely understood so far. It would be considered that total adsorption amount of iodine on AgX was contributed to both physisorption and chemisorption. Two sorption mechanisms are, in general, known to occur in the substrate of 13X. As reported in previous studies, the chemisorption capacity of NaX at 150 °C is about 30 mg I<sub>2</sub>/g-NaX. The chemisorption capacity of AgX at 150 °C is about 214 mg I<sub>2</sub>/g-AgX [9]. This is 60% of the stoichiometric capacity based on the number of silver sites per gram. It can be inferred from the experimental data that there is a fundamental difference in the

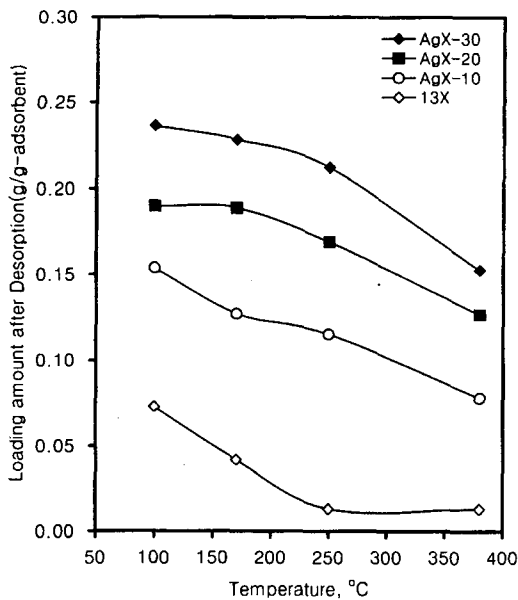

**Fig. 7. Variation in Loading Amounts After Desorption on Various AgX with Increasing Desorption Temperature**

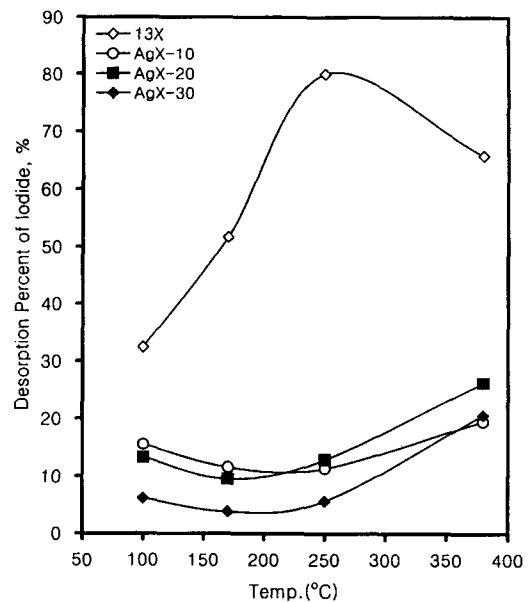

**Fig. 8. Variation in Desorption Percent on Various AgX with Increasing Desorption Temperature, Compared to Adsorption Amounts**

type of chemisorption, which takes place in AgX as compared to NaX.

It is considered that the operating temperature for  $\text{CH}_3\text{I}$  removal is in the range of  $170^\circ\text{C}$  to  $250^\circ\text{C}$ . It would be convinced that the optimal temperature for removal of methyl iodide by AgX is about  $200^\circ\text{C}$ . The decrease in adsorption amounts at  $380^\circ\text{C}$  may be due to the higher desorption rate than the adsorption rate including chemical reaction between silver and methyl iodide. In connection with practical application for radioiodine removal, methyl iodide is known to be the most difficult species to separate from off-gas.  $\text{I}_2$  showed a higher DF (Decontamination Factor) than  $\text{CH}_3\text{I}$  because the reactivity of  $\text{CH}_3\text{I}$  with silver would be low.

Taking into account the adsorption mechanism, higher adsorption amount at  $100^\circ\text{C}$  is mainly due to the physical adsorption of methyl iodide. Therefore, desorption characteristics from iodide-

adsorbed AgX at various temperature is needed to analyze silver utilization for the removal of methyl iodide. Loading capacity of iodide on AgX was evaluated by desorption tests. Desorbed amount of iodine from AgX was measured after flowing dry air through the AgX with a saturated amount of iodine in a column, and desorption condition was the same one applied to adsorption test.

The physically adsorbed methyl iodide can be desorbed reversibly, but the chemically adsorbed iodide remains irreversibly within structure as a form of AgI. Stoichiometrically, silver ion-exchanged amounts of 10wt%, 20wt% and 30wt% stands for uptake of 117 mg, 234 mg and 351 mg-I per gram of AgX, respectively. Variations in the loading amount of iodide after desorption test with increasing desorption temperature represent in Fig. 7. Fig. 8 shows the desorption percent from adsorbed amount with increasing temperature. Except for  $100^\circ\text{C}$ ,

desorbed amount on 13X at above 170 °C was very high up to 80%, compared to silver ion-exchanged zeolite. As mentioned earlier, the chemisorption capacity of NaX at 150 °C is about 30 mg I<sub>2</sub>/g-NaX, which is similar to our results. Concerning about results of AgX-10wt%, desorption percent has minimum values in the ranges of 150 °C to 250 °C, and the loading amounts of iodide in these ranges are close to stoichiometric adsorption amount. However, in the case of AgX-20 and 30wt%, the loading amounts are low compared to stoichiometric amount. The reason for this result will be discussed in next paragraph.

### 3.3. Evaluation of Silver Utilization for Methyl Iodide Adsorption by AgX

It is observed that a high silver ion-exchanged level contributes to an increase of adsorption capacity of methyl iodide. This means that the active sites of zeolite increased accordingly with the increase of the number of Ag<sup>+</sup> ions, implying that chemical reaction between Ag<sup>+</sup> and CH<sub>3</sub>I takes place on silver-associated sites.

As shown in Table 2 or Fig.2, the reduction in a total pore volume of AgX, especially micropore volume, seems to be almost proportional to the silver ion-exchanged amount. However, the decrease in surface area of AgX-10 wt% is not so great compared to the others, AgX-20 and 30 wt%. It was also reported that no silver nodules on AgX or AgZ were detected [10]. As a result, partial blocking of micropore due to silver ion exchange forms AgX sites that methyl iodide molecules hardly diffuse into. The partial blocking of the adsorption sites would causes the increase in the portion of unreacted silver sites in the matrix. According to the previous studies [10,13], elemental iodine and methyl iodide has a kinetic diameter of ~ 5 Å and ~6 Å, respectively. In

general, the average pore size of 13X is ~12 Å in radius. The effective pore sizes could be slightly changed by substituting Ag<sup>+</sup> for Na<sup>+</sup>.

As mentioned earlier, the adsorption capacity at a given silver ion-exchanged level showed the maximum value in a range of 150 °C ~ 250 °C. However, little is known about the nature of the interaction of AgX with methyl iodide, Therefore, it is necessary to reveal the exact reaction mechanism between AgX and methyl iodide. Since the oxygen anion on zeolite structure is bonded into an aluminum tetrahedron, a plausible mechanism for the reaction taking place in AgX might be :

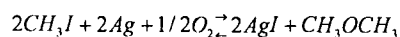
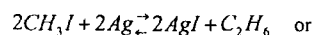

It would be expected that only partial bond breakage and formation would be involved to give a cyclic structure. The reaction should also be thermodynamically favored because the iodide is more stable than the oxide and the O-I bond is stronger than the I-I bond [10, 12, 18]. The previous studies reported the reaction between methyl iodide and silver on AgZ(Silver ion-exchanged Modernite) as following equation [10, 12, 13]:

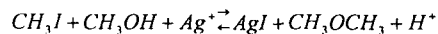
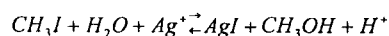

However, the exact mechanism of reaction between methyl iodide and AgX has not yet been reported. Based on a stoichiometric chemical reaction between methyl iodide and silver amount using above equation, the silver utilization percent for removal of iodide can be calculated by following equation.

$$\frac{\text{Loading amount after desorption (g-I/g-adsorbent)}}{\text{Removal amount by stoichiometric reaction(g-I/g-adsorbent)}} \times 100$$



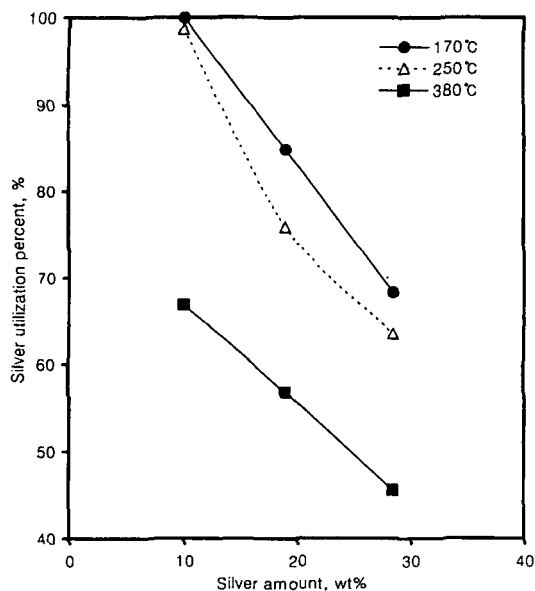

**Fig. 9. Silver Utilization Percent for Removal of Methyl Iodide with Silver Ion-exchanged Level in the Ranges of 170°C to 380°C**

As shown in Fig. 9, the highest silver utilization percent of ~ 100 % was obtained at the 10 wt% of AgX in the range of 150°C to 250°C, but higher silver ion-exchange level makes it lower silver utilization. This result would be inferred that all silver-ion in the matrix of zeolite would not chemically react with the methyl iodide as the silver ion-exchanged level increases. In case of results obtained at 100 °C, it is difficult to calculate a silver utilization percent, because physical adsorption, not chemical reaction, would partially contributes to loading amounts after desorption. Some information to verify above mechanism will be presented in next paper.

#### 4. Conclusions

Removal capacity of methyl iodide on various silver ion-exchanged zeolites (AgX) was evaluated

as the function of temperature and silver ion-exchanged level. As the result of preliminary test, zeolite 13X as a base adsorbent showed the good performance in removal of methyl iodide at a high temperature up to 380°C compared to the activated carbon and zeocarbon. It is identified that methyl iodide adsorbed on 13X is mainly physisorption. The maximum adsorption capacity of AgX was observed in the range of 150 to 250 °C. The adsorption capacity of AgX increases when the silver ion-amount becomes higher. However, it was found that the 10 wt% of AgX as an optimal silver ion-exchanged level resulted in silver utilization of about 100% for the effective removal of methyl iodide at 150 °C ~ 250 °C.

#### Acknowledgement

This project has been carried out under the Nuclear R&D Program by MOST

#### References

1. International Commission on Radiation Protection, Recommendations of the ICRP, ICRP Publication, 26, (1977).
2. National Council on Radiation Protection and Measurement, Recommendations on Limits for Exposure to Ionizing Radiation, NCRP 91 (1987).
3. R.H. Bellamy, "Elemental Iodine and Methyl Iodide Adsorption on Activated Charcoal at Low Concentrations," Nucl. Safety, **15**, 16, (1974).
4. J.G.Wilhelm and J. Furrer, "Iodine Filters in Nuclear Power Stations," In CEC Seminar on Radioactive Effluents from Nuclear Fuel Reprocessing Plants, Kernforschungszentrum, Karlsruhe, Germany (1977).
5. International Atomic Energy Agency, Design of Off-Gas and Air Cleaning Systems at Nuclear

- Power Plants, IAEA Tech. No. 274, Vienna (1987).
6. D.A. Collins, L.R. Taylor and R. Taylor, "Development of Exchanged Charcoals for Trapping Methyl Iodide at High Humidities", Proc. 9th AEC Air Cleaning Conf., CONF-660904, **I**, 150, (1966).
  7. D.T. Pence and B.A. Staples, "Solid Adsorbents for Collection and Storage of Iodine-129 from Reprocessing Plants," In Proc. 13th AEC Air Cleaning Conference, CONF-740807, 157, Atomic Energy Commission, Washington, DC, August, (1974).
  8. Radiological Significance and Management of Tritium, Carbon-14, Krypton-85, Iodine-129 Arising from the Nuclear Fuel Cycle, Nuclear Energy Agency, Organization for Economic Cooperation and Development, Paris (1980).
  9. T.R. Thomas, B.A. Staples and L.P. Murphy, J.T. Nichlos, Airborne Elemental Iodine Loading Capacities of Metal Exchanged Zeolites and a Method for Recycling Silver Zeolite, ICP-1119 (1977).
  10. R.T. Jubin, "The Mass Transfer Dynamics of Gaseous Methyl Iodide Adsorption by Silver-Exchanged Modernite," PhD Thesis, The University of Tennessee, Knoxville, USA (1994).
  11. K. Funabashi, T. Fukasawa and M. Kikuchi, "Investigation of Silver-Exchanged Alumina for Removal of Radioactive Methyl Iodide," Nuclear Technology, **109**, 366-372, (1995).
  12. R.D. Scheele, L.L. Burger and C.L. Matsuzaki, "Methyl Iodide Sorption by Reduced Silver Modernite," PNL-4489, Pacific National Lab., Richland, Washington (1983).
  13. R.D. Scheele, L.L. Burger, "Evaluation of Silver Modernite for Radioiodine Retention at the Purex Process Facility Modification," PNL-6261, Pacific National Lab., Richland, Washington (1987).
  14. B.S. Choi, G.I. Park, et al., "A Study on the Removal of Radioiodine on Silver-exchanged Adsorbents," Proceeding of the KNS Autumn Meeting, **II**, Korea (1997).
  15. H. Deuber, "Investigations on the Retention of Elemental Radioiodine by Activated Carbon at High Temperature," Nuclear technology, **72**, 44-48, (1986).
  16. J.L. Kovach, "The Environment and Current States of Radioiodine Control", Proc, 16th Nuclear Air Cleaning Conf., CONF-801038, 417, U.S. Department of Energy, (1981).
  17. M. Matsuoka, E. Matsuda and K.Tsuji, H. Yamashita, M. Anpo, "The Photocatalytic Decomposition of Nitric Oxide on the Silver(I) Ion-Exchanged ZSM-5 Catalyst", Chemistry Letters, 375-376(1995).
  18. J.A. Dean, Lange's Handbook of Chemistry-Bond Dissociation Energies, 14th Ed., McGraw-Hill, Inc.(1992).