

Time-Delayed and Quantized Fuzzy Systems: Stability Analysis and Controller Design

Chang-Woo Park, Hyung-Jin Kang, Jung-Hwan Kim, and Mignon Park

Abstract: In this paper, the design methodology of digital fuzzy controller(DFC) for the systems with time-delay is presented and the qualitative effects of the quantizers in the digital implementation of a fuzzy controllers are investigated. We propose the fuzzy feedback controller whose output is delayed with unit sampling period and predicted. The analysis and the design problem considering time-delay become very easy because the proposed controller is synchronized with the sampling time. The stabilization problem of the digital fuzzy system with time-delay is solved by linear matrix inequality(LMI) theory. Furthermore, we analyze the stability of the quantized fuzzy system. Our results prove that when quantization is taken into account, one only has convergence to some small neighborhood about origin. We develop a fuzzy control system for backing up a computer-simulated truck-trailer with the consideration of time-delay and quantization effect. By using the proposed method, we analyze the quantization effect to the system and design a DFC which guarantees the stability of the control system in the presence of time-delay.

Keywords: time-delay, quantization, linear matrix inequality, digital fuzzy control

I. Introduction

Digital fuzzy control systems are hybrid dynamical systems which usually consist of an interconnection of a continuous-time plant and discrete time fuzzy controller. The analysis and design of such fuzzy systems have been of continuing interest for several decades. Since Takagi-Sugeno(TS) fuzzy model was presented[1], various kinds of TS fuzzy model based controllers have been suggested[2]-[4] and systematic design of the fuzzy controller can be possible. The stability of the overall fuzzy systems could be determined by the Lyapunov stability analysis and recently linear matrix inequality(LMI) based approaches have been used to determine the existence of a common positive definite matrix[5][6].

However, most of these results do not take into account time-delay and quantization effects in digital implementation of the fuzzy control systems. A linear controller like PID controllers has a short time-delay in calculating the output since its algorithm is so simple. On the other hand, in the case of a complex algorithm like fuzzy logic, a considerable time-delay can occur because so many calculations are needed to get the output. And quantization error can occur in the discrete fuzzy controller and the interconnection elements such as A/D and D/A converters. Extensive research has already been done in the conventional control to find the solutions.[7]-[10] However, for fuzzy control systems, there are few studies on the stabilization problem for especially systems with time-delay and quantizers.[11][12]

In the present paper, we propose the design method of a fuzzy feedback controller which guarantees the stability of the system in the presence of time-delay and investigate the qualitative stability analysis of the digital fuzzy control systems with quantizers in both the controller and the interconnection elements.

We first study the design method of digital fuzzy controller(DFC) considering time-delay. If the system has a considerable time-delay, the analysis and the design of the controller are very difficult since the time-delay makes the output of the controller not synchronized with the sampling time. We propose

the fuzzy feedback controller whose output is delayed with unit sampling period and predicted using current states and the control input to the plant at previous sampling time. The analysis and the design of the controller become very easy because the output of the proposed controller is synchronized with the sampling time. Therefore, the proposed control system can be designed using the conventional methods such as parallel distributed compensation(PDC)[13] and LMI based analysis.

Next, we study the qualitative effects of quantization of the proposed digital fuzzy control system. It is shown that if the trivial solution of the fuzzy control system without quantization is asymptotically stable, then the solutions of the digital fuzzy control system with quantizers are uniformly ultimately bounded.

To verify the validity and the effectiveness of the scheme, the proposed fuzzy feedback controller is applied to backing up control of a computer-simulated truck-trailer with time-delay and quantizers.

II. Discrete TS fuzzy model based control

In the discrete time TS fuzzy systems without control input, the dynamic properties of each subspace can be expressed as the following fuzzy IF-THEN rules[1].

$$\begin{aligned} \text{Rule } i: & \text{ If } x_1(k) \text{ is } M_{i1} \cdots \text{ and } x_n(k) \text{ is } M_{in} \quad i = 1, 2, \dots, r \\ & \text{ THEN } \mathbf{x}(k+1) = \mathbf{G}_i \mathbf{x}(k), \end{aligned} \quad (1)$$

where $\mathbf{x}(k) = [x_1(k) \ x_2(k) \ \cdots \ x_n(k)]^T \in \mathfrak{R}^n$ denotes the state vector of the fuzzy system, r is the number of the IF-THEN rules, and M_{ij} is fuzzy set.

If the state $\mathbf{x}(k)$ is given, the output of the fuzzy system expressed as the fuzzy rules of Eq. (1) can be inferred as follows.

$$\mathbf{x}(k+1) = \frac{\sum_{i=1}^r w_i(k) \mathbf{G}_i \mathbf{x}(k)}{\sum_{i=1}^r w_i(k)} = \sum_{i=1}^r h_i(k) \mathbf{G}_i \mathbf{x}(k), \quad (2)$$

Manuscript received: May 10, 2000., Accepted: Nov. 28, 2000.

Chang-woo Park, Hyung-Jin Kang, Jung-Hwan Kim, Mignon Park:
ICS Lab., Dept. of Electronic Eng., Yonsei Univ.

※ This work was supported by the brain korea 21 project.

where $w_i(k) = \prod_{j=1}^n \overline{M}_{ij}(x_j(k))$, $\overline{M}_{ij}(x_j(k))$ is the grade of membership of $x_j(t)$ in M_{ij} and $h_i(k) = \frac{w_i(k)}{\sum_{i=1}^r w_i(k)}$

A sufficient condition for ensuring the stability of the fuzzy system(2) is given in Theorem 1.

Theorem 1: The equilibrium point for the discrete time fuzzy system (2) is asymptotically stable in the large if there exists a common positive definite matrix \mathbf{P} satisfying the following inequalities.

$$\mathbf{G}_i^T \mathbf{P} \mathbf{G}_i - \mathbf{P} < \mathbf{0}, i = 1, 2, \dots, r. \quad (3)$$

Proof : The proof will be given in Appendix A.

In the discrete time fuzzy system with control input to the plant, the dynamic properties of each subspace can be expressed as the following fuzzy IF-THEN rules.

Rule i : If $x_1(k)$ is M_{i1} ... and $x_n(k)$ is M_{in} $i = 1, 2, \dots, r$
 THEN $\mathbf{x}(k+1) = \mathbf{A}_i \mathbf{x}(k) + \mathbf{B}_i \mathbf{u}(k)$,

(4)

where ,

$\mathbf{u}(k) = [u_1(k) \ u_2(k) \ \dots \ u_m(k)]^T \in \mathfrak{R}^m$ denotes the input of the fuzzy system.

If the set of $(\mathbf{x}(k), \mathbf{u}(k))$ is given the output of the fuzzy system (4) can be obtained as follows.

$$\begin{aligned} \mathbf{x}(k+1) &= \frac{\sum_{i=1}^r w_i(k) \{ \mathbf{A}_i \mathbf{x}(k) + \mathbf{B}_i \mathbf{u}(k) \}}{\sum_{i=1}^r w_i(k)} \\ &= \sum_{i=1}^r h_i(k) \{ \mathbf{A}_i \mathbf{x}(k) + \mathbf{B}_i \mathbf{u}(k) \}, \end{aligned} \quad (5)$$

where $w_i(k) = \prod_{j=1}^n \overline{M}_{ij}(x_j(k))$, $\overline{M}_{ij}(x_j(k))$ is the grade of membership of $x_j(t)$ in M_{ij} and $h_i(k) = \frac{w_i(k)}{\sum_{i=1}^r w_i(k)}$.

In PDC, the fuzzy controller is designed distributively according to the corresponding rule of the plant[13]. Therefore, the PDC for the plant (4) can be expressed as follows.

Rule j : If $x_1(k)$ is M_{j1} ... and $x_n(k)$ is M_{jn} $j = 1, 2, \dots, r$
 THEN $\mathbf{u}(k) = -\mathbf{F}_j \mathbf{x}(k)$.

(6)

The fuzzy controller output of Eq. (6) can be inferred as follows.

$$\mathbf{u}(k) = -\frac{\sum_{i=1}^r w_i(k) \mathbf{F}_i \mathbf{x}(k)}{\sum_{i=1}^r w_i(k)} = -\sum_{j=1}^r h_j(k) \mathbf{F}_j \mathbf{x}(k), \quad (7)$$

where $h_j(k)$ is the same function in Eq. (5).

Substituting Eq. (7) into Eq. (5) gives the following closed

loop discrete time fuzzy system.

$$\begin{aligned} \mathbf{x}(k+1) &= \sum_{i=1}^r h_i(k) \{ \mathbf{A}_i \mathbf{x}(k) - \mathbf{B}_i \sum_{j=1}^r h_j(k) \mathbf{F}_j \mathbf{x}(k) \} \\ &= \sum_{i=1}^r \sum_{j=1}^r h_i(k) h_j(k) \{ \mathbf{A}_i - \mathbf{B}_i \mathbf{F}_j \} \mathbf{x}(k). \end{aligned} \quad (8)$$

Defining $\mathbf{G}_{ij} = \mathbf{A}_i - \mathbf{B}_i \mathbf{F}_j$, the following equation is obtained.

$$\begin{aligned} \mathbf{x}(k+1) &= \sum_{i=1}^r h_i(k) h_i(k) \mathbf{G}_{ii} \mathbf{x}(k) \\ &\quad + 2 \sum_{i < j} h_i(k) h_j(k) \left\{ \frac{\mathbf{G}_{ij} + \mathbf{G}_{ji}}{2} \right\} \mathbf{x}(k). \end{aligned} \quad (9)$$

Applying Theorem 1 to analyze the stability of the discrete time fuzzy system (9), the stability condition of Theorem 2 can be obtained.

Theorem 2: The equilibrium point of the closed loop discrete time fuzzy system (9) is asymptotically stable in the large if there exists a common positive definite matrix \mathbf{P} which satisfies the following inequalities for all i and j except the set (i, j) satisfying $h_i(k) \cdot h_j(k) = 0$.

$$\mathbf{G}_{ii}^T \mathbf{P} \mathbf{G}_{ii} - \mathbf{P} < \mathbf{0} \quad (10a)$$

$$\left(\frac{\mathbf{G}_{ij} + \mathbf{G}_{ji}}{2} \right)^T \mathbf{P} \left(\frac{\mathbf{G}_{ij} + \mathbf{G}_{ji}}{2} \right) - \mathbf{P} \leq \mathbf{0}, \quad i < j \quad (10b)$$

Proof: The proof of this result is similar to the proof of Theorem 1.

If $\mathbf{B} = \mathbf{B}_1 = \mathbf{B}_2 = \dots = \mathbf{B}_r$ in the plant (5) is satisfied, the closed loop system (8) can be obtained as follows.

$$\begin{aligned} \mathbf{x}(k+1) &= \sum_{i=1}^r h_i(k) \{ \mathbf{A}_i \mathbf{x}(k) - \mathbf{B} \sum_{j=1}^r h_j(k) \mathbf{F}_j \mathbf{x}(k) \} \\ &= \sum_{i=1}^r h_i(k) \{ \mathbf{A}_i - \mathbf{B} \mathbf{F}_i \} \mathbf{x}(k) = \sum_{i=1}^r h_i(k) \mathbf{G}_i \mathbf{x}(k) \end{aligned} \quad (11)$$

where $\mathbf{G}_i = \mathbf{A}_i - \mathbf{B} \mathbf{F}_i$

Hence, Theorem 1 can be applied to the stability analysis of the closed loop system (11).

III. LMI based approach for fuzzy system design

To prove the stability of the discrete time fuzzy control system by Theorem 1 and Theorem 2, the common positive definite matrix \mathbf{P} must be solved. LMI theory can be applied to solving \mathbf{P} [14]. LMI theory is one of the numerical optimization techniques. Many of the control problems can be transformed into LMI problems and the recently developed Interior-point method can be applied to solving numerically the optimal solution of these LMI problems[15].

Definition 1: Linear matrix inequality can be defined as follows.

$$\mathbf{F}(\mathbf{x}) = \mathbf{F}_0 + \sum_{i=1}^m x_i \mathbf{F}_i > \mathbf{0}, \quad (12)$$

where $\mathbf{x} = [x_1 \ x_2 \ \dots \ x_m]^T$ is the parameter, the

symmetric matrices $F_i = F_i^T \in \mathfrak{R}^{n \times n}$, $i = 0, \dots, m$ are given, and the inequality symbol " $> \mathbf{0}$ " means that $F(\mathbf{x})$ is the positive definite matrix.

LMI of Eq. (12) means the convex constraints for \mathbf{x} . Convex constraint problems for the various \mathbf{x} can be expressed as LMI of Eq. (12). LMI feasibility problem can be described as follows.

LMI feasibility problem: The problem of finding $\mathbf{x}^{\text{feasp}}$ which satisfies $F(\mathbf{x}^{\text{feasp}}) > \mathbf{0}$ or proving the unfeasibility in the case that LMI $F(\mathbf{x}) > \mathbf{0}$ is given.

And the stability condition of **Theorem 1** can be transformed into the LMI feasibility problem as follows.

LMI feasibility problem about the stability condition of Theorem 1: The problem of finding \mathbf{P} which satisfies the LMI's, $\mathbf{P} > \mathbf{0}$ and $\mathbf{G}_i^T \mathbf{P} \mathbf{G}_i - \mathbf{P} < \mathbf{0}$, $i = 1, 2, \dots, r$ or proving the unfeasibility in the case that $\mathbf{A}_i \in \mathfrak{R}^{n \times n}$, $i = 1, 2, \dots, r$ are given.

If the design object of a controller is to guarantee the stability of the closed loop system (5), the design of the PDC fuzzy controller(7) is equivalent to solving the following LMI feasibility problem using Schur complements[14].

LMI feasibility problem equivalent to the PDC design problem (Case I): The problem of finding $\mathbf{X} > \mathbf{0}$ and $\mathbf{M}_1, \mathbf{M}_2, \dots, \mathbf{M}_r$ which satisfy the following inequalities.

$$\begin{bmatrix} \mathbf{X} & \{\mathbf{A}_i \mathbf{X} - \mathbf{B}_i \mathbf{M}_i\}^T \\ \mathbf{A}_i \mathbf{X} - \mathbf{B}_i \mathbf{M}_i & \mathbf{X} \end{bmatrix} > \mathbf{0}, \quad i = 1, 2, \dots, r$$

$$\begin{bmatrix} \mathbf{X} & 1/2\{\mathbf{A}_i \mathbf{X} + \mathbf{A}_j \mathbf{X} - \mathbf{B}_i \mathbf{M}_i - \mathbf{B}_j \mathbf{M}_j\}^T \\ 1/2\{\mathbf{A}_i \mathbf{X} + \mathbf{A}_j \mathbf{X} - \mathbf{B}_i \mathbf{M}_i - \mathbf{B}_j \mathbf{M}_j\} & \mathbf{X} \end{bmatrix} > \mathbf{0}$$

$i < j$

where $\mathbf{X} = \mathbf{P}^{-1}$, $\mathbf{M}_1 = \mathbf{F}_1 \mathbf{X}$, $\mathbf{M}_2 = \mathbf{F}_2 \mathbf{X}$, ..., and $\mathbf{M}_r = \mathbf{F}_r \mathbf{X}$.

If $\mathbf{B} = \mathbf{B}_1 = \mathbf{B}_2 = \dots = \mathbf{B}_r$ is satisfied, the design of the PDC fuzzy controller(7) is equivalent to solving the following LMI feasibility problem.

LMI feasibility problem equivalent to the PDC design problem (Case II): The problem of finding $\mathbf{X} > \mathbf{0}$ and $\mathbf{M}_1, \mathbf{M}_2, \dots, \mathbf{M}_r$ which satisfy the following equations.

$$\begin{bmatrix} \mathbf{X} & \{\mathbf{A}_i \mathbf{X} - \mathbf{B}_i \mathbf{M}_i\}^T \\ \mathbf{A}_i \mathbf{X} - \mathbf{B}_i \mathbf{M}_i & \mathbf{X} \end{bmatrix} > \mathbf{0} \quad i = 1, 2, \dots, r$$

where $\mathbf{X} = \mathbf{P}^{-1}$, $\mathbf{M}_1 = \mathbf{F}_1 \mathbf{X}$, $\mathbf{M}_2 = \mathbf{F}_2 \mathbf{X}$, ..., and $\mathbf{M}_r = \mathbf{F}_r \mathbf{X}$.

The feedback gain matrices $\mathbf{F}_1, \mathbf{F}_2, \dots, \mathbf{F}_r$ and the common positive definite matrix \mathbf{P} can be given by the LMI solutions, \mathbf{X} and $\mathbf{M}_1, \mathbf{M}_2, \dots, \mathbf{M}_r$, as follows.

$$\mathbf{P} = \mathbf{X}^{-1}, \quad \mathbf{F}_1 = \mathbf{M}_1 \mathbf{X}^{-1}, \quad \mathbf{F}_2 = \mathbf{M}_2 \mathbf{X}^{-1}, \quad \dots, \quad \text{and} \\ \mathbf{F}_r = \mathbf{M}_r \mathbf{X}^{-1}$$

IV. Digital fuzzy control system with time-delay

In real control systems, a considerable time-delay can occur due to a sensor and a controller. Let τ be defined as the sum of all this time-delay. In the case of the real system, the ideal fuzzy controller of Eq. (6) can be described as follows due to the time-delay.

Rule j : If $x_1(kT)$ is M_{j1} ... and $x_n(kT)$ is M_{jn}

THEN $\mathbf{u}(kT + \tau) = -\mathbf{F}_j \mathbf{x}(kT)$

$$j = 1, 2, \dots, r \quad (13)$$

Because the time-delay makes the output of controller not synchronized with the sampling time, Theorem 1 can not be applied to this system. Therefore the analysis and the design of the controller are very difficult. In this paper, DFC which has the following fuzzy rules is proposed to consider the time-delay of the fuzzy plant (4). In this scheme, the computing time-delay is approximated to be one sampling period and the output of the fuzzy controller is delayed with unit sampling period and predicted. Hence the analysis and the design of the controller are very easy because the output of the proposed controller is synchronized with the sampling time.

Rule j : If $x_1(k)$ is M_{j1} ... and $x_n(k)$ is M_{jn}

THEN $\mathbf{u}(k+1) = \mathbf{D}_j \mathbf{u}(k) + \mathbf{E}_j \mathbf{x}(k)$

$$j = 1, 2, \dots, r. \quad (14)$$

The output of DFC (14) is inferred as follows.

$$\mathbf{u}(k+1) = \frac{\sum_{j=1}^r w_j(k) \{\mathbf{D}_j \mathbf{u}(k) + \mathbf{E}_j \mathbf{x}(k)\}}{\sum_{j=1}^r w_j(k)}$$

$$= \sum_{j=1}^r h_j(k) \{\mathbf{D}_j \mathbf{u}(k) + \mathbf{E}_j \mathbf{x}(k)\}. \quad (15)$$

The general timing diagram of fuzzy control loop is shown in Fig. 1. T is the sampling period of the control loop, τ_v and τ_c are the delay made by sensor system and fuzzy controller respectively. Therefore the output of the controller is applied to the plant after overall delay $\tau = \tau_v + \tau_c$.

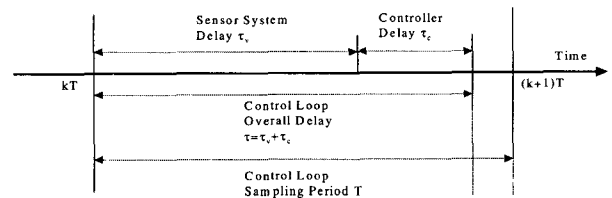

Fig. 1. Timing diagram of the fuzzy control loop.

The output timing of a ideal controller, a delayed controller, and the proposed controller is shown in the Fig. 2. In the ideal controller, it is assumed that there is no time-delay. If this controller is implemented in real systems the time-delay τ is added like Eq. (13). The analysis and the design of this system with delayed controller are very difficult since the output of controller is not synchronized with the sampling time.

On the other hand, the analysis and the design of the proposed controller are very easy because the controller output is synchronized with the sampling time delayed with unit sampling period. Using this proposed controller, we can realize a control algorithm during the time interval $T - \tau_v$ in Fig. 1.

In this time interval, a complex algorithm such as not only fuzzy algorithm but also nonlinear control algorithm can be sufficiently realized in real time.

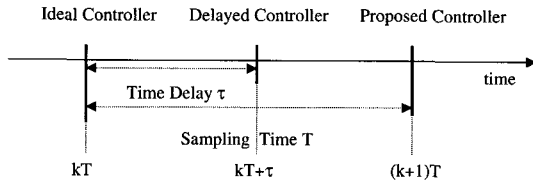

Fig. 2. Output timing of the controllers (Three cases).

Combining the fuzzy plant (5) with the DFC (15), the closed loop system is given as follows.

$$\begin{bmatrix} \mathbf{x}(k+1) \\ \mathbf{u}(k+1) \end{bmatrix} = \sum_{i=1}^r h_i(k) \begin{bmatrix} \mathbf{A}_i & \mathbf{B}_i \\ \mathbf{E}_i & \mathbf{D}_i \end{bmatrix} \begin{bmatrix} \mathbf{x}(k) \\ \mathbf{u}(k) \end{bmatrix}. \quad (16)$$

Defining the new state vector as $\mathbf{w}(k) = \begin{bmatrix} \mathbf{x}(k) \\ \mathbf{u}(k) \end{bmatrix}$, the closed loop system (16) can be modified as

$$\mathbf{w}(k+1) = \sum_{i=1}^r h_i(k) \mathbf{G}_i \mathbf{w}(k), \quad (17)$$

where $\mathbf{G}_i = \begin{bmatrix} \mathbf{A}_i & \mathbf{B}_i \\ \mathbf{E}_i & \mathbf{D}_i \end{bmatrix}$.

Hence, the stability condition of the closed loop system (17) becomes the same as the sufficient condition of Theorem 1 and the stability can be determined by solving LMI feasibility problem about the stability condition of Theorem 1. Also, the design problem of the DFC guaranteeing the stability of the closed loop system can be transformed into LMI feasibility problem. To do this, the design problem of the DFC is transformed into the design problem of the PDC fuzzy controller.

PDC design problem equivalent to DFC design problem:

The problem of designing the PDC fuzzy controller $\mathbf{v}(k) = -\sum_{j=1}^r h_j(k) \bar{\mathbf{F}}_j \mathbf{w}(k)$ in the case that the fuzzy plant $\mathbf{w}(k+1) = \sum_{i=1}^r h_i(k) \{\bar{\mathbf{A}}_i \mathbf{w}(k) + \bar{\mathbf{B}} \mathbf{v}(k)\}$ is given.

where $\bar{\mathbf{A}}_i = \begin{bmatrix} \mathbf{A}_i & \mathbf{B}_i \\ \mathbf{0} & \mathbf{0} \end{bmatrix}$, $\bar{\mathbf{B}} = \begin{bmatrix} \mathbf{0} \\ \mathbf{I} \end{bmatrix}$, and $\bar{\mathbf{F}}_j = -[\mathbf{E}_j \quad \mathbf{D}_j]$.

Therefore, using the same notation in section 3, the design problem of the DFC can be equivalent to the following LMI feasibility problem.

LMI feasibility problem equivalent to DFC design problem: The problem of finding $\mathbf{X} > \mathbf{0}$ and $\mathbf{M}_1, \mathbf{M}_2, \dots, \mathbf{M}_r$ which satisfy following equation.

$$\begin{bmatrix} \mathbf{X} & \{\bar{\mathbf{A}}_i \mathbf{X} - \bar{\mathbf{B}} \mathbf{M}_i\}^T \\ \bar{\mathbf{A}}_i \mathbf{X} - \bar{\mathbf{B}} \mathbf{M}_i & \mathbf{X} \end{bmatrix} > \mathbf{0}, \quad i=1, 2, \dots, r$$

where $\mathbf{X} = \mathbf{P}^{-1}$, $\mathbf{M}_1 = \bar{\mathbf{F}}_1 \mathbf{X}$, $\mathbf{M}_2 = \bar{\mathbf{F}}_2 \mathbf{X}$, \dots , and $\mathbf{M}_r = \bar{\mathbf{F}}_r \mathbf{X}$.

The feedback gain matrices $\bar{\mathbf{F}}_1, \bar{\mathbf{F}}_2, \dots, \bar{\mathbf{F}}_r$ and the common positive definite matrix \mathbf{P} can be given by the LMI solutions, \mathbf{X} and $\mathbf{M}_1, \mathbf{M}_2, \dots, \mathbf{M}_r$, as follows.

$$\mathbf{P} = \mathbf{X}^{-1}, \quad \bar{\mathbf{F}}_1 = \mathbf{M}_1 \mathbf{X}^{-1}, \quad \bar{\mathbf{F}}_2 = \mathbf{M}_2 \mathbf{X}^{-1}, \quad \dots, \quad \bar{\mathbf{F}}_r = \mathbf{M}_r \mathbf{X}^{-1}. \quad (18)$$

Therefore, the control gain matrices $\mathbf{D}_1, \dots, \mathbf{D}_r, \mathbf{E}_1, \dots, \mathbf{E}_r$ of the proposed DFC can be obtained from the feedback gain matrices $\bar{\mathbf{F}}_1, \bar{\mathbf{F}}_2, \dots, \bar{\mathbf{F}}_r$.

V. Digital fuzzy control system with quantizers

In the implementation of digital fuzzy controllers, quantization is unavoidable. This is due to the fact that computers store numbers with finite bits. In this present section, we investigate the nonlinear effects caused by quantization.

If $x \in \mathfrak{R}$ is the input to a quantizer and $Q(x)$ is the output of a quantizer, the quantization processing can be described as follows.

$$Q(x) = x + p(x), \quad (19)$$

where $p(x)$ describes the quantization nonlinearities determined by the several method of quantization such as round off, value truncation, magnitude truncation, etc. There are many types of quantization. Presently, we will concern ourselves primarily with the most commonly used fixed-point quantization which can be characterized by the relation

$$|p(x)| < \varepsilon, \quad (20)$$

where positive constants, ε in Eq. (20) is quantization error determined by the characteristics of a quantizer.

Therefore, the quantized state $Q_x(\mathbf{x}(k))$ with respect to the system state $\mathbf{x} \in \mathfrak{R}^n$ can be defined as the following form.

$$\mathbf{x}_q(k) = Q_x(\mathbf{x}(k)) = \begin{bmatrix} Q_x(x_1(k)) \\ Q_x(x_2(k)) \\ \vdots \\ Q_x(x_n(k)) \end{bmatrix} = \begin{bmatrix} x_1(k) \\ x_2(k) \\ \vdots \\ x_n(k) \end{bmatrix} + \begin{bmatrix} p_x(x_1(k)) \\ p_x(x_2(k)) \\ \vdots \\ p_x(x_n(k)) \end{bmatrix} = \mathbf{x}(k) + \mathbf{p}_x(\mathbf{x}(k)), \quad (21)$$

where $\|\mathbf{p}_x(\mathbf{x}(k))\| \leq \varepsilon_x$.

A Similar definition can be obtained for the quantized controller $Q_u(\mathbf{u}(k))$ with respect to the control input $\mathbf{u} \in \mathfrak{R}^m$ as

$$\mathbf{u}_q(k) = Q_u(\mathbf{u}(k)) = \begin{bmatrix} Q_u(u_1(k)) \\ Q_u(u_2(k)) \\ \vdots \\ Q_u(u_m(k)) \end{bmatrix} = \begin{bmatrix} u_1(k) \\ u_2(k) \\ \vdots \\ u_m(k) \end{bmatrix} + \begin{bmatrix} p_u(u_1(k)) \\ p_u(u_2(k)) \\ \vdots \\ p_u(u_m(k)) \end{bmatrix} = \mathbf{u}(k) + \mathbf{p}_u(\mathbf{u}(k)), \quad (22)$$

where $\|\mathbf{p}_u(\mathbf{u}(k))\| \leq \varepsilon_u$.

In real digital control systems, the TS fuzzy plant model includes the quantized input term as

$$\mathbf{x}(k+1) = \sum_{i=1}^r h_i(k) \{ \mathbf{A}_i \mathbf{x}(k) + \mathbf{B}_i \mathbf{u}_q(k) \}. \quad (23)$$

In order to control this fuzzy plant model with quantized input, the proposed digital fuzzy controller(15) can be transformed into the Eq. (24)

$$\begin{aligned} \mathbf{u}_q(k+1) &= Q_u \left(\sum_{i=1}^r h_i(k) \{ \mathbf{D}_i \mathbf{u}_q(k) + \mathbf{E}_i \mathbf{x}_q(k) \} \right) \\ &= \sum_{i=1}^r h_i(k) \{ \mathbf{D}_i \mathbf{u}_q(k) + \mathbf{E}_i \mathbf{x}_q(k) \} + \Delta_u(k), \quad (24) \end{aligned}$$

where,

$$\begin{aligned} \Delta_u(k) &= Q_u \left(\sum_{i=1}^r h_i(k) \{ \mathbf{D}_i \mathbf{u}_q(k) + \mathbf{E}_i \mathbf{x}_q(k) \} \right) \\ &\quad - \sum_{i=1}^r h_i(k) \{ \mathbf{D}_i \mathbf{u}_q(k) + \mathbf{E}_i \mathbf{x}_q(k) \} \\ &= \mathbf{p}_u \left(\sum_{i=1}^r h_i(k) \{ \mathbf{D}_i \mathbf{u}_q(k) + \mathbf{E}_i \mathbf{x}_q(k) \} \right). \end{aligned}$$

The state $\mathbf{x}(k)$ in the fuzzy plant model(23) and the state $\mathbf{x}_q(k)$ in the fuzzy controller(24) need to be unified to derive the closed loop equation. Therefore, we apply the quantization operator to the equation of the fuzzy plant model(23).

$$\begin{aligned} \mathbf{x}_q(k+1) &= Q_x(\mathbf{x}(k+1)) = Q_x \left(\sum_{i=1}^r h_i(k) \{ \mathbf{A}_i \mathbf{x}(k) + \mathbf{B}_i \mathbf{u}_q(k) \} \right) \\ &= \sum_{i=1}^r h_i(k) \{ \mathbf{A}_i \mathbf{x}_q(k) + \mathbf{B}_i \mathbf{u}_q(k) \} + \Delta_x(k), \quad (25) \end{aligned}$$

where,

$$\begin{aligned} \Delta_x(k) &= Q_x \left(\sum_{i=1}^r h_i(k) \{ \mathbf{A}_i \mathbf{x}(k) + \mathbf{B}_i \mathbf{u}_q(k) \} \right) \\ &\quad - \sum_{i=1}^r h_i(k) \{ \mathbf{A}_i \mathbf{x}_q(k) + \mathbf{B}_i \mathbf{u}_q(k) \} \\ &= Q_x \left(\sum_{i=1}^r h_i(k) \{ \mathbf{A}_i \mathbf{x}(k) + \mathbf{B}_i \mathbf{u}_q(k) \} \right) \\ &\quad - \sum_{i=1}^r h_i(k) \{ \mathbf{A}_i Q_x(\mathbf{x}(k)) + \mathbf{B}_i \mathbf{u}_q(k) \} \\ &= Q_x \left(\sum_{i=1}^r h_i(k) \{ \mathbf{A}_i \mathbf{x}(k) + \mathbf{B}_i \mathbf{u}_q(k) \} \right) \\ &\quad - \sum_{i=1}^r h_i(k) \{ \mathbf{A}_i (\mathbf{x}(k) + \mathbf{p}_x(\mathbf{x}(k))) + \mathbf{B}_i \mathbf{u}_q(k) \} \\ &= Q_x \left(\sum_{i=1}^r h_i(k) \{ \mathbf{A}_i \mathbf{x}(k) + \mathbf{B}_i \mathbf{u}_q(k) \} \right) \\ &\quad - \sum_{i=1}^r h_i(k) \{ \mathbf{A}_i \mathbf{x}(k) + \mathbf{B}_i \mathbf{u}_q(k) \} - \sum_{i=1}^r h_i(k) \mathbf{A}_i \mathbf{p}_x(\mathbf{x}(k)) \\ &= \mathbf{p}_x \left(\sum_{i=1}^r h_i(k) \{ \mathbf{A}_i \mathbf{x}(k) + \mathbf{B}_i \mathbf{u}_q(k) \} \right) \\ &\quad - \sum_{i=1}^r h_i(k) \mathbf{A}_i \mathbf{p}_x(\mathbf{x}(k)). \end{aligned}$$

Hence, the state space model of the quantized closed loop system can be obtained from Eq. (25) and (24) as

$$\mathbf{w}(k+1) = \sum_{i=1}^r h_i(k) \mathbf{G}_i \mathbf{w}(k) + \Delta(k), \quad (26)$$

where $\mathbf{w}(k) = \begin{bmatrix} \mathbf{x}_q(k) \\ \mathbf{u}_q(k) \end{bmatrix}$ is the augmented state and

$$\mathbf{G}_i = \begin{bmatrix} \mathbf{A}_i & \mathbf{B}_i \\ \mathbf{E}_i & \mathbf{D}_i \end{bmatrix}, \quad \Delta(k) = \begin{bmatrix} \Delta_x(k) \\ \Delta_u(k) \end{bmatrix}.$$

If there exists any reference signal or noise, the state space model (26) can be

$$\mathbf{w}(k+1) = \sum_{i=1}^r h_i(k) \mathbf{G}_i \mathbf{w}(k) + \Delta(k) + \mathbf{r}(k), \quad (27)$$

where $\mathbf{r}(k)$ is due to the reference signal or noise.

Now, we analyze the stability of the digital fuzzy systems considering quantization effects. Let us define the norm $\|\bullet\|_P$ in \mathfrak{R}^n to obtain the stability condition for the closed loop system (27) as follows.

$$\|\mathbf{w}(k)\|_P = (\mathbf{w}^T(k) \mathbf{P} \mathbf{w}(k))^{\frac{1}{2}}, \quad (28)$$

where $\mathbf{P} \in \mathfrak{R}^{n \times n}$ is symmetric positive definite matrix.

Definition 2[16]: The digital fuzzy system (27) is said to be *uniformly ultimately bounded* with bound α if and only if for any $\beta > 0$ there exists $T(\beta) > 0$, independent of $K \geq 0$, such that whenever $|\mathbf{w}_K| \leq \beta$ and $k \geq T(\beta)$, one has $|\mathbf{w}_{k+K}| \leq \alpha$.

Remark 1: Uniform ultimate boundness is similar to uniform asymptotic stability, except that the attracting point $x=0$ is now replaced by an attracting set given by $\{x \in \mathfrak{R}^n : |x| \leq \alpha\}$.

Theorem 3: If the following two conditions are satisfied, there exist a very small positive constant δ such that $\|\Delta(k)\|_P < \delta$ for all integers k and positive constant J such that the closed loop system (27) is uniformly ultimately bounded by bound $J\delta$.

1) There exists a common positive definite matrix \mathbf{P} for the system

$$\mathbf{w}(k+1) = \sum_{i=1}^r h_i(k) \mathbf{G}_i \mathbf{w}(k), \quad (29)$$

which satisfies the sufficient condition (3) in Theorem 1.

2) There exists $\bar{\delta} > 0$ such that $r(k) \in B_{\bar{\delta}}\{x \mid \|x\| < \bar{\delta}\}$ for $k > 0$.

Proof :

If there exists a common positive definite matrix \mathbf{P} satisfying the sufficient condition(3) in Theorem 1, $V(\mathbf{w}(k)) = \|\mathbf{w}(k)\|_P = (\mathbf{w}^T(k) \mathbf{P} \mathbf{w}(k))^{\frac{1}{2}}$ can be a norm Lyapunov function for the system (29).

Since the system(29) satisfies the asymptotical stability by assumption, there exists a constant c such that

$$\begin{aligned} \Delta V_{(29)}(\mathbf{w}(k)) &= V(\mathbf{w}(k+1)) - V(\mathbf{w}(k)) \\ &= \left\| \sum_{i=1}^r h_i(k) \mathbf{G}_i \mathbf{w}(k) \right\|_p - \|\mathbf{w}(k)\|_p \leq (c-1) \|\mathbf{w}(k)\|_p \\ &= (c-1) V(\mathbf{w}(k)), \quad 0 < c < 1, \end{aligned}$$

where $\Delta V_{(29)}(\mathbf{w}(k))$ denotes the first forward difference along the solution of the system(29).

The first forward difference for the closed loop system (27) can be given as

$$\begin{aligned} \Delta V_{(27)}(\mathbf{w}(k), k) &= \left\| \sum_{i=1}^r h_i(k) \mathbf{G}_i \mathbf{w}(k) + \Delta(k) + \mathbf{r}(k) \right\|_p - \|\mathbf{w}(k)\|_p \\ &\leq \left\| \sum_{i=1}^r h_i(k) \mathbf{G}_i \mathbf{w}(k) \right\|_p - \|\mathbf{w}(k)\|_p + \|\Delta(k)\|_p + \|\mathbf{r}(k)\|_p \\ &\leq (c-1) V(\mathbf{w}(k)) + \|\Delta(k)\|_p + \|\mathbf{r}(k)\|_p \\ &\leq (c-1) V(\mathbf{w}(k)) + \delta + \|\mathbf{r}(k)\|_p. \end{aligned}$$

Therefore, whenever $\mathbf{w}(K)$ is picked so that $V(\mathbf{w}(K)) = \|\mathbf{w}(K)\|_p \leq \beta$, then $V(\mathbf{w}(K))$ must be less than the solution of the following comparison equation[17].

$$\begin{aligned} X_{k+1} - X_k &= (c-1) X_k + \delta + \|\mathbf{r}(k)\|_p, \quad X_K = \beta, \\ &\text{or} \\ X_{k+1} &= c X_k + \delta + \|\mathbf{r}(k)\|_p, \quad X_K = \beta \\ &\text{for all integers } k \geq K. \end{aligned} \quad (30)$$

The solution of the comparison equation (30) can be obtained as

$$X_{k+K} = c^k \beta + \frac{1-c^k}{1-c} \delta + \sum_{j=0}^k c^{k-j} \|\mathbf{r}(j+K)\|_p. \quad (31)$$

Because $0 < c < 1$ in Eq. (31), $c^k \rightarrow 0$ as $k \rightarrow \infty$. And $\gamma_k(K) = \sum_{j=0}^k c^{k-j} \|\mathbf{r}(j+K)\|_p < \bar{\delta} \sum_{j=0}^k c^{k-j} = \bar{\delta} \frac{1-c^{k+1}}{1-c}$.

Now we can say that V_{k+K} converges uniformly to $\frac{1}{1-c}(\delta + \bar{\delta})$ for $K \geq 0$ as $k \rightarrow \infty$ from the comparison equation (30) and $J = \frac{1}{1-c}(1 + \frac{\bar{\delta}}{\delta})$ will do because

$$V(\mathbf{w}_{k+K}) \leq X_{k+K}. \quad \blacksquare$$

If the closed loop system(26) is uniformly ultimately bounded by bound $J\bar{\delta}$, the system converges to the attracting set $\{\mathbf{w} \in \mathbb{R}^{m+n} : \|\mathbf{w}\|_p \leq J\bar{\delta}\}$, not to the equilibrium point $\mathbf{w} = \mathbf{0}$. If $\Delta(k) = 0$ in closed loop system(26), that is, quantization error does not exist, the constant δ is zero and the attracting set becomes to $\mathbf{w} = \mathbf{0}$. In this case, the closed loop system is asymptotically stable.

Theorem 3 shows the analysis of qualitative characteristics of the fuzzy control systems considering quantization. The positive constant J is related to the equation $\mathbf{w}(k+1) = \sum_{i=1}^r h_i(k) \mathbf{G}_i \mathbf{w}(k)$, not to $\Delta(k)$. Therefore, once the digital fuzzy control system is stably designed, it does not diverge although quantization errors exist and the smaller the quantization errors become, the more the asymptotic stability is guaranteed.

VI. Backing up control of computer-simulated truck-trailer

We have shown an analysis technique of the proposed DFC under the condition that time-delay and quantizers exist. Some papers have reported that backing up control of a computer-simulated truck-trailer could be realized by fuzzy control[5][13][18]. However, these studies have not analyzed the time-delay and quantization effects to the control system. In this section, we apply the proposed controller to backing up control of a truck-trailer system with time-delay and investigate the quantization effects to the system.

1. Models of a truck-trailer

M. Tokunaga derived the following model about the truck-trailer system [18]. Figure 3 shows the schematic diagram of this system.

$$\begin{aligned} x_0(k+1) &= x_0(k) + vT/l \tan[u(k)] \\ x_1(k) &= x_0(k) - x_2(k) \\ x_2(k+1) &= x_2(k) + vT/L \sin[x_1(k)] \\ x_3(k+1) &= x_3(k) + vT \cos[x_1(k)] \sin[\{x_2(k+1) + x_2(k)\}/2] \\ x_4(k+1) &= x_4(k) + vT \cos[x_1(k)] \cos[\{x_2(k+1) + x_2(k)\}/2] \end{aligned} \quad (32)$$

where $u(k)$: The steering angle of the truck

l : The length of the truck, L : The length of the trailer

T : Sampling time, v : The constant backward speed

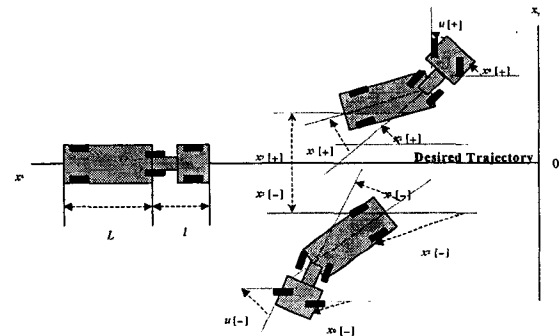

Fig. 3. Truck trailer model and its coordinate system.

K. Tanaka defined the state vector as $\mathbf{x}(k) = [x_1(k) \ x_2(k) \ x_3(k)]^T$ in the truck-trailer model (32) and expressed the plant as two following fuzzy rules[13].

$$\begin{aligned} \text{Rule 1: If } x_2(k) + vT/\{2L\} x_1(k) \text{ is } M_1 \\ \text{THEN } \mathbf{x}(k+1) &= \mathbf{A}_1 \mathbf{x}(k) + \mathbf{B}_1 u(k) \\ \text{Rule 2: If } x_2(k) + vT/\{2L\} x_1(k) \text{ is } M_2 \\ \text{THEN } \mathbf{x}(k+1) &= \mathbf{A}_2 \mathbf{x}(k) + \mathbf{B}_2 u(k), \end{aligned} \quad (33)$$

where

$$\mathbf{A}_1 = \begin{bmatrix} 1 - \frac{vT}{L} & 0 & 0 \\ \frac{vT}{L} & 1 & 0 \\ \frac{v^2 T^2}{2L} & vT & 1 \end{bmatrix}, \quad \mathbf{A}_2 = \begin{bmatrix} 1 - \frac{vT}{L} & 0 & 0 \\ \frac{vT}{L} & 1 & 0 \\ \frac{dv^2 T^2}{2L} & dvT & 1 \end{bmatrix},$$

$$\mathbf{B} = \mathbf{B}_1 = \mathbf{B}_2 = \begin{bmatrix} \frac{vT}{l} \\ l \\ 0 \\ 0 \end{bmatrix},$$

$l = 2.8[\text{m}]$, $L = 5.5[\text{m}]$, $v = -1.0[\text{m/s}]$, $T = 2.0[\text{s}]$,
 $d = 10^{-2} / \pi$

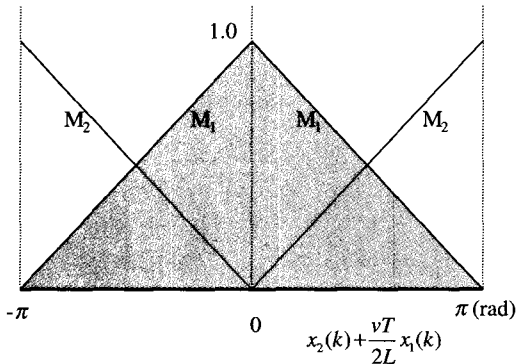

Fig. 4. Membership function.

2. Fuzzy control system without time-delay and quantizers

In this subsection, backing up control of a truck-trailer is simulated by the conventional discrete time fuzzy controller under the assumption that no time-delay and quantizers exist.

To solve the backward parking problem of Eq. (33), the PDC fuzzy controller can be designed as follows.

- Rule 1: If $x_2(k) + vT / \{2L\} \cdot x_1(k)$ is M_1
 THEN $u(k) = \mathbf{F}_1^T \mathbf{x}(k)$
 - Rule 2: If $x_2(k) + vT / \{2L\} \cdot x_1(k)$ is M_2
 THEN $u(k) = \mathbf{F}_2^T \mathbf{x}(k)$,
- (34)

where $\mathbf{F}_1 = \begin{bmatrix} 1.2837 \\ -0.4139 \\ 0.0201 \end{bmatrix}$ and $\mathbf{F}_2 = \begin{bmatrix} 0.9773 \\ -0.0709 \\ 0.0005 \end{bmatrix}$.

Ricatti equation for linear discrete systems was used to determine these feedback gains. The detailed derivation of these feedback gains was given in [13].

Substituting Eq. (34) into Eq. (33) yields the following closed loop system due to $\mathbf{B} = \mathbf{B}_1 = \mathbf{B}_2$.

$$\mathbf{x}(k+1) = \sum_{i=1}^2 h_i(k) \mathbf{G}_i \mathbf{x}(k), \quad (35)$$

where

$$\mathbf{G}_1 = \begin{bmatrix} 0.448 & 0.296 & -0.014 \\ -0.364 & 1 & 0 \\ 0.364 & -2 & 1 \end{bmatrix} \text{ and}$$

$$\mathbf{G}_2 = \begin{bmatrix} 0.448 & 0.296 & -0.014 \\ -0.364 & 1 & 0 \\ 0.116 \times 10^{-2} & -0.637 \times 10^{-2} & 1 \end{bmatrix}.$$

Since there exists the common positive matrix \mathbf{P} which satisfies the stability sufficient condition (3), the closed loop system is asymptotically stable in the large. That is, the backward parking can be accomplished for all initial conditions. Common positive definite matrix:

$$\mathbf{P} = \begin{bmatrix} 113.9 & -92.61 & 2.540 \\ -92.61 & 110.7 & -3.038 \\ 2.540 & -3.038 & 0.5503 \end{bmatrix}.$$

Two initial conditions used for the simulations of the truck-trailer system are given in Table 1.

Table 1. The initial conditions of the truck-trailer system.

CASE	$x_1(0)[\text{deg}]$	$x_2(0)[\text{deg}]$	$x_3(9)[\text{m}]$
CASE I	0	0	20
CASE II	-90	135	-10

Figure 5(a) and (b) show the simulation results for CASE I and CASE II. As can be seen in these Figures, the backing up control for each initial condition is accomplished effectively.

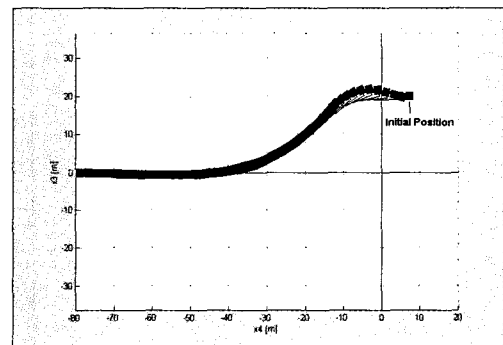

(a) Fuzzy control system without time-delay and quantizers for CASE I.

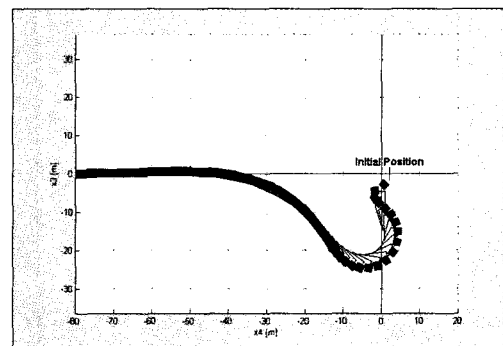

(b) Fuzzy control system without time-delay and quantizers for CASE II

Fig. 5. Simulation results without time-delay and quantizers.

3. Fuzzy control system with time-delay and without quantizers

In many cases, vision sensor is generally needed to measure the state $\mathbf{x}(k)$ of the truck-trailer system[19]. The time-delay can be made by the vision sensor in the transferring of image and the image processing. Also, it can be made by the digital hardware in the calculation of the fuzzy algorithm and by the actuator in adjusting the steering angle. Let τ be defined as the sum of all this time-delay. In the case of the real system, the ideal fuzzy controller of Eq. (34) can be described as follows due to the time-delay.

$$\begin{aligned} \text{Rule 1: If } x_2(kT) + vT/\{2L\} \cdot x_1(kT) \text{ is } M_1 \\ \text{THEN } u(kT + \tau) = \mathbf{F}_1^T \mathbf{x}(kT) \\ \text{Rule 2: If } x_2(kT) + vT/\{2L\} \cdot x_1(kT) \text{ is } M_2 \\ \text{THEN } u(kT + \tau) = \mathbf{F}_2^T \mathbf{x}(kT). \end{aligned} \quad (36)$$

The simulations are executed in the case that the time-dealy τ is a half of the sampling time ($\tau=1$ [sec]). Figure 6 (a) and (b) show that the truck-trailer system is oscillating and the fuzzy controller can not accomplish the backing up control effectively.

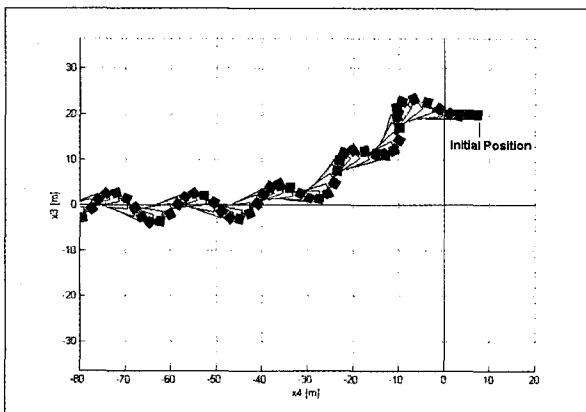

(a) Fuzzy control system with time-delay($\tau=1$) and without quantizers for CASE I

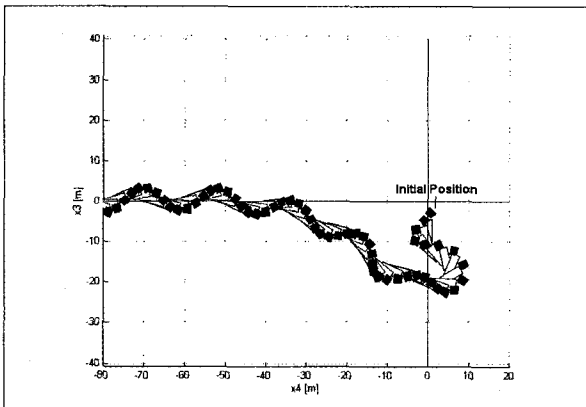

(b) Fuzzy control system with time-delay($\tau=1$) and without quantizers for CASE II

Fig. 6. Simulation results with time-delay and quantizers.

4. Proposed fuzzy control systems with time-delay and quantizer

In the present subsection, we design the DFC considering time-delay and analyze the quantization effects to the control system. Following the design technique of DFC in section 4, we can construct the DFC for the backing up control problem as follows.

$$\begin{aligned} \text{Rule 1: If } x_2(k) + vT/\{2L\} \cdot x_1(k) \text{ is } M_1 \\ \text{THEN } u(k+1) = \mathbf{D}_1 u(k) + \mathbf{E}_1 \mathbf{x}(k) \\ \text{Rule 2: If } x_2(k) + vT/\{2L\} \cdot x_1(k) \text{ is } M_2 \\ \text{THEN } u(k+1) = \mathbf{D}_2 u(k) + \mathbf{E}_2 \mathbf{x}(k). \end{aligned} \quad (37)$$

Combining Eq. (33) with Eq. (37), the augmented closed loop system is given as follows.

$$\mathbf{w}(k+1) = \sum_{i=1}^2 h_i(k) \mathbf{G}_i \mathbf{w}(k), \quad (38)$$

$$\text{where } \mathbf{G}_1 = \begin{bmatrix} \mathbf{A}_1 & \mathbf{B}_1 \\ \mathbf{E}_1 & \mathbf{D}_1 \end{bmatrix}, \quad \mathbf{G}_2 = \begin{bmatrix} \mathbf{A}_2 & \mathbf{B}_2 \\ \mathbf{E}_2 & \mathbf{D}_2 \end{bmatrix}.$$

To obtain the control gain matrices $\mathbf{D}_1, \mathbf{D}_2, \mathbf{E}_1, \mathbf{E}_2$ guaranteeing the stability of the closed loop system (38), we solve the LMI feasibility problem equivalent to DFC design problem as follows.

The problem of finding $\mathbf{X} > \mathbf{0}$ and $\mathbf{M}_1, \mathbf{M}_2$ which satisfy the following inequalities:

$$\begin{bmatrix} \mathbf{X} & \{\bar{\mathbf{A}}_i \mathbf{X} - \bar{\mathbf{B}} \mathbf{M}_i\}^T \\ \bar{\mathbf{A}}_i \mathbf{X} - \bar{\mathbf{B}} \mathbf{M}_i & \mathbf{X} \end{bmatrix} > \mathbf{0}$$

$$\text{where } \bar{\mathbf{A}}_i = \begin{bmatrix} \mathbf{A}_i & \mathbf{B}_i \\ \mathbf{0} & \mathbf{0} \end{bmatrix} \text{ and } \bar{\mathbf{B}} = \begin{bmatrix} \mathbf{0} \\ \mathbf{I} \end{bmatrix}, \quad i=1, 2.$$

The matrices \mathbf{X} and $\mathbf{M}_1, \mathbf{M}_2$ in LMI's are determined using a convex optimization technique offered by [20].

$$\begin{aligned} \mathbf{X} &= \begin{bmatrix} 157.0056 & 61.9680 & -1.6565 & 220.727 \\ 61.9680 & 50.4822 & 69.8423 & 53.4329 \\ -1.6565 & 69.8423 & 489.4416 & -2.3866 \\ 220.727 & 53.4329 & -2.3866 & 442.6866 \end{bmatrix}, \\ \mathbf{M}_1 &= [-96.3672 \quad -43.1521 \quad 41.8056 \quad -5.8356], \\ \mathbf{M}_2 &= [-116.3143 \quad -66.0021 \quad 1.3065 \quad -22.9842]. \end{aligned}$$

The feedback gains and a common positive definite matrix, \mathbf{P} are determined by the relationship (18) as follows.

$$\mathbf{P} = \mathbf{X}^{-1} = \begin{bmatrix} 0.0995 & -0.1036 & 0.0149 & -0.0370 \\ -0.1036 & 0.1373 & -0.0198 & 0.0350 \\ 0.0149 & -0.0198 & 0.0049 & -0.0050 \\ -0.0370 & 0.0350 & -0.0050 & 0.0165 \end{bmatrix}, \quad (39)$$

$$\bar{\mathbf{F}}_1 = \mathbf{M}_1 \mathbf{X}^{-1} = -[\mathbf{E}_1 \quad \mathbf{D}_1] = [-3.9047 \quad 2.6765 \quad -0.3020 \quad 1.5869],$$

$$\bar{\mathbf{F}}_2 = \mathbf{M}_2 \mathbf{X}^{-1} = -[\mathbf{E}_2 \quad \mathbf{D}_2] = [-3.8624 \quad 2.1564 \quad -0.3102 \quad 1.6123].$$

Therefore, the closed loop system is asymptotically stable in the large and the control gain matrices are given as follows by PDC design problem equivalent to DFC design problem.

$$D_1 = -1.5869, \quad D_2 = -1.6123,$$

$$E_1 = [3.9047 \quad -2.6765 \quad 0.3020], \quad E_2 = [3.8624 \quad -2.1564 \quad 0.3102].$$

Next, we analyze the stability of the fuzzy control system with the consideration of quantization. The quantization problem is unavoidable because digital sensors such as vision sensors and encoders are to be needed in order to control the truck-trailer system.

There exists a common positive definite matrix P (39) for the closed loop system (38) and $r(k) = \mathbf{0}$ since it is a regulation problem. Hence, all the sufficient conditions of Theorem 3 are satisfied. Therefore, we can say that the closed loop fuzzy system is uniformly ultimately bounded and does not diverge.

Figure 7 (a) shows the simulation result of the designed DFC with time-delay ($\tau = 1$ [sec]) and quantizers with the precision, $\varepsilon = 10^{-2}$. The output of proposed fuzzy controller is delayed with unit sampling period and predicted using current state and previous control input. Hence, the output of the controller is synchronized with sampling time and the stability in the digital implementation of the control system can be guaranteed. As

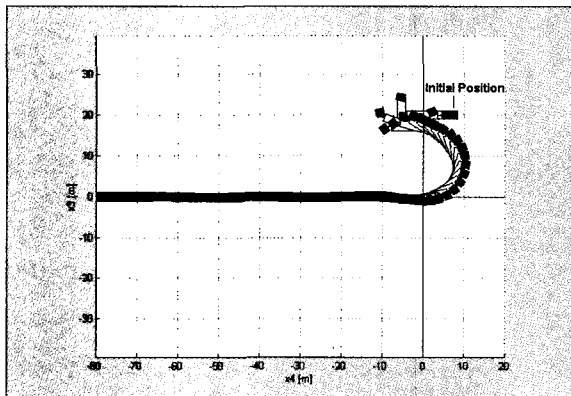

(a) Result by proposed DFC with time-delay and quantizers for CASE I

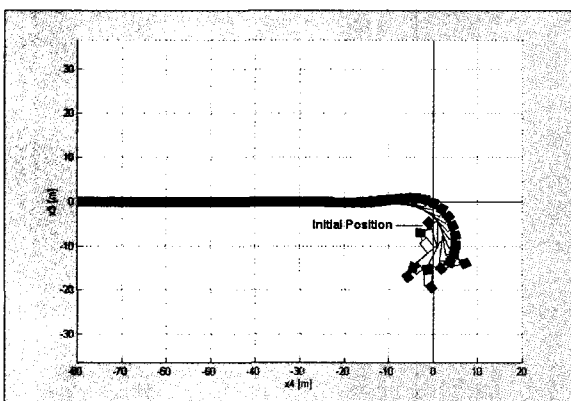

(b) Result by proposed DFC with time-delay and without Quantizers for CASE II

Fig. 7. Simulation results with time-delay and quantizers.

can be seen in the figure, the backward parking is accomplished successfully for CASE I compared with Fig. 6 although a considerable time-delay exists. However, due to the quantization effects, the solution of the present feedback control system seems to have oscillation with small amplitude. Thus, we can say that the closed loop system converges to some small neighborhood of origin. On the other hand, Fig. 7 (b) presents the simulation result for CASE II under the assumption that the same time-delay exists and there is no quantization. Clearly, the system tends to zero asymptotically with no oscillation in the presence of time-delay.

VII. Conclusions

In this paper, we have developed a DFC framework for a class of systems with time-delay and quantizers. Because the proposed controller was synchronized with the sampling time delayed with unit sampling period and predicted, the analysis and the design problem considering time-delay could be very easy. Convex optimization technique based on LMI has been utilized to solve the problem of finding stable feedback gains and a common Lyapunov function. Therefore, the stability of the system was guaranteed in the existence of time-delay and the real-time control processing could be possible. Furthermore, we have proved that quantization has the effect of replacing convergence of solutions to the origin by convergence to some small neighborhood of the origin. To show the effectiveness and feasibility of the proposed design and analysis scheme, we have developed a digital fuzzy control system for backing up a computer-simulated truck-trailer with time-delay and quantizers. Through the simulations, we have shown that the proposed DFC could achieve backing up control of a truck-trailer successfully although a considerable time-delay existed. It was also shown that in the presence of quantizers, the system was uniformly ultimately bounded.

References

- [1] T. Takagi and M. Sugeno, "Fuzzy identification of systems and its applications to modeling and control", *IEEE Trans. Systems, Man, and Cybernetics*, vol. 15, no. 1, pp. 116-132, 1985.
- [2] K. Tanaka and M. Sugeno, "Stability analysis and design of fuzzy control systems", *Fuzzy Sets and Systems*, vol. 45, no. 2, pp. 135-156, 1992.
- [3] C. S. Ting, T. H. S. Li, and F. C. Kung, "An approach to systematic design of fuzzy control system", *Fuzzy Sets and Systems*, vol. 77, pp. 151-166, 1996.
- [4] H. O. Wang, K. Tanaka, and M.F. Griffin, "An approach to fuzzy control of nonlinear systems: Stability and design issues", *IEEE Trans. Fuzzy Systems*, vol. 4, no. 1, pp. 14-23, 1996.
- [5] K. Tanaka, T. Kosaki, and H. O. Wang, "Backing control problem of a mobile robot with multiple trailers: fuzzy modeling and LMI-based design", *IEEE Trans. Fuzzy Systems*, vol. 28, no. 3, pp. 329-337, 1998.
- [6] K. Kiriakidis, "Non-linear control system design via fuzzy modelling and LMIs", *Int. J. Control*, vol. 72, no. 7/8, pp. 676-685, 1999.

[7] I. Horowitz, "Some properties of delayed controls", *Int. J. Contr.*, vol. 38, no. 5, pp. 977-990, 1983.

[8] A. Leva, C. Maffezzoni, and R. Scattolini, "Self-tuning PI-PID regulators for stable systems with varying delay", *Automatica*, vol. 30, no. 7, pp. 1171-1183, 1994.

[9] S. Majhi and D. P. Atherton, "Autotuning and controller design for processes with small time delays", *IEE Proceedings-Control Theory and Applications*, vol. 146, no. 5, pp. 415-425, 1999.

[10] Bo Hu and A. N. Michel, "Some qualitative properties of multirate digital control systems", *IEEE Trans. Automatic Control*, vol. 44, no. 4, pp. 765-770, 1999.

[11] I. Del Campo and J. M. Tarela, "Consequences of the digitization on the performance of a fuzzy logic controller", *IEEE Trans. Fuzzy Systems*, vol. 7, no. 1, pp. 85-92, 1999.

[12] H. X. Li and S. K. Tso, "Higher order fuzzy control structure for higher order or time-delay systems", *IEEE Trans. Fuzzy Systems*, vol. 7, no. 5, pp. 540-542, 1999.

[13] K. Tanaka and M. Sano, "A robust stabilization problem of fuzzy control systems and its application to backing up control of a truck-trailer", *IEEE Trans. Fuzzy Systems*, vol. 2, no. 2, pp. 119-133, 1994.

[14] S. Boyd, L. E. Ghaoui, E. Feron, and V. Balakrishnan, *Linear matrix inequalities in systems and control theory*, SIAM, Philadelphia, 1994.

[15] Y. Nesterov and A. Nemirovsky, *Interior-point polynomial methods in convex programming*, SIAM, Philadelphia, 1994.

[16] K. Khalil, *Nonlinear systems*, Prentice-Hall, Inc., 1996.

[17] R. K. Miller and A. N. Michel, *Ordinary differential equations*, Academic, 1982.

[18] M. Tokunaga and H. Ichihashi, "Backer-upper control of a trailer truck by neuro-fuzzy optimal control", *Proc. of 8th Fuzzy System Symp.*, Japan, pp. 49-52, May, 1992.

[19] K. Tanaka and T. Kosaki, "Design of a stable fuzzy controller for an articulated vehicle", *IEEE Trans. Systems, Man, and Cybernetics*, vol. 27, no. 3, pp. 552-558, 1997.

[20] P. Gahinet, A. Nemirovski, A. Laub, and M. Chilali, *LMI Control Toolbox*, The MathWorks, Inc., 1995.

Appendix A

The proof of Theorem 1

A lemma is necessary in order to prove the condition of Theorem 3-2. The proof of the lemma is given in [2].

Lemma [2]: Let \mathbf{P} be a positive definite matrix such that

$$\mathbf{A}^T \mathbf{P} \mathbf{A} - \mathbf{P} < \mathbf{0} \text{ and } \mathbf{B}^T \mathbf{P} \mathbf{B} - \mathbf{P} < \mathbf{0},$$

then

$$\mathbf{A}^T \mathbf{P} \mathbf{B} + \mathbf{B}^T \mathbf{P} \mathbf{A} - 2\mathbf{P} < \mathbf{0},$$

where $\mathbf{A}, \mathbf{B}, \mathbf{P} \in \mathfrak{R}^{n \times n}$

Let us consider a scalar function $V(\mathbf{x}(k))$ such that

$$V(\mathbf{x}(k)) = \mathbf{x}^T(k) \mathbf{P} \mathbf{x}(k),$$

where \mathbf{P} is a positive definite matrix. This function satisfies the following properties.

- a) $V(\mathbf{0}) = 0$
- b) $V(\mathbf{x}(k)) > 0$ for $\mathbf{x}(k) \neq \mathbf{0}$
- c) $V(\mathbf{x}(k)) \rightarrow \infty$ as $\|\mathbf{x}(k)\| \rightarrow \infty$,

And we can obtain $\Delta V(\mathbf{x}(k))$ as follows.

$$\begin{aligned} \Delta V(\mathbf{x}(k)) &= V(\mathbf{x}(k+1)) - V(\mathbf{x}(k)) \\ &= \mathbf{x}^T(k+1) \mathbf{P} \mathbf{x}(k+1) - \mathbf{x}^T(k) \mathbf{P} \mathbf{x}(k) \\ &= \left\{ \sum_{i=1}^r h_i(k) \mathbf{G}_i \mathbf{x}(k) \right\}^T \mathbf{P} \left\{ \sum_{i=1}^r h_i(k) \mathbf{G}_i \mathbf{x}(k) \right\} - \mathbf{x}^T(k) \mathbf{P} \mathbf{x}(k) \\ &= \mathbf{x}^T(k) \left[\left\{ \sum_{i=1}^r h_i(k) \mathbf{G}_i \right\}^T \mathbf{P} \left\{ \sum_{i=1}^r h_i(k) \mathbf{G}_i \right\} - \mathbf{P} \right] \mathbf{x}(k) \\ &= \sum_{i=1}^r (h_i(k))^2 \mathbf{x}^T(k) \{ \mathbf{G}_i^T \mathbf{P} \mathbf{G}_i - \mathbf{P} \} \mathbf{x}(k) \\ &+ \sum_{i < j} h_i(k) h_j(k) \mathbf{x}^T(k) \{ \mathbf{G}_i^T \mathbf{P} \mathbf{G}_j + \mathbf{G}_j^T \mathbf{P} \mathbf{G}_i - 2\mathbf{P} \} \mathbf{x}(k). \end{aligned}$$

By using Lemma [2] and Eq. (3), we can obtain $\Delta V(\mathbf{x}(k)) < 0$.

Hence, $V(\mathbf{x}(k))$ is a Lyapunov function and the discrete time fuzzy system (2) is asymptotically stable in the large. ■



Chang-Woo Park

Was born in Seoul, Korea, in 1973. He received the B.S. degree in electronics from Korea University and M.S. degree in electronics from Yonsei University, Seoul, Korea, in 1997 and 1999, respectively. He is currently working toward the Ph.D. degree in electrical and computer engineering at Yonsei University, Seoul, Korea. His current research interests include fuzzy control theory, nonlinear control theory and robot vision system.



Hyung-Jin Kang

Was born in Seoul, Korea, in 1970. He received the B.S., M.S., and Ph.D. degrees in electronic engineering from Yonsei University, Seoul, Korea, in 1992, 1994, and 1999, respectively. He is currently a researcher in Mando Machinery Corporation, Seoul. His research interests include robotics and automation, machine vision, intelligent control and nonlinear control



Jung-Hwan Kim

Received the B.S. degree in electronics from Chungnam National University in 1984 and M.S. degree in electronics from Yonsei University, Seoul, Korea in 1996. He received Ph. D. degree in electrical and computer engineering from Yonsei University, Seoul, Korea, in 2000. Currently he works at the Hyupsung University, Korea. His current research interests include vision system and image processing, fuzzy theory and nonlinear control.

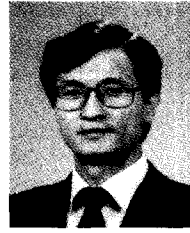

Mignon Park

Received the B.S. and M.S. degrees in electronics from Yonsei University, Seoul, Korea, in 1973 and 1977, respectively, and the Ph. D. degree from the University of Tokyo, Tokyo, Japan, in 1982. From 1977 to 1982, he was a Researcher at the Institute Biomedical Engineering, University of Tokyo, Japan. In 1982 he was a Researcher at Massachusetts Institute of Technology, Cambridge, MA, and at the University of California, Berkely. He was a Visiting Researcher in Robotics Division, Mechanical Engineering Laboratory (MEL) and Ministry of International Trade and Industry (MITI), Tsukuba, Japan, from 1986 to 1987. Since 1982, he has been a Professor in the Electrical and Computer Department of Yonsei University. His research interests include fuzzy control and application engineering, robotics, and fuzzy biomedical system, etc. Dr. Park was a Program Chairman of the Korea-Japan Joint Conference on Fuzzy Systems and Engineering in 1992, and the Vice-Chair of IEEE-FUZZ99 in 1999. He was the chairman of Korea-Japan Joint Workshop in 2000. He is a member of the Japanese Society for Fuzzy Theory and Systems and the Japanese Society for Biomedical Fuzzy Systems, among others.