

# Performance Improvement of a Modified Perturbation Method via a Least Square Approach for Sensor Arrays

\*Byong Kun Chang

Abstract

This paper concerns a modified perturbation method and a least square approach to synthesize an optimum beam pattern of a thinned sensor array with respect to element spacing. In the modified perturbation, the antenna spacing is perturbed iteratively such that the sidelobes are equalized via a linear programming approach. The least square approach is proposed to improve the array performance for the thinned array using the fact that the number of sidelobes is more than the number of element spacings.

It is demonstrated that the least square approach performs better than the modified perturbation method.

## I. Introduction

A linear sensor array is an array whose elements are arranged on a straight line. If the elements are spaced uniformly every half wavelength, the array is called a filled array. If the array consists of fewer number of elements than the filled array with the same array length, the array is called a thinned array.

The thinned array is an efficient system which prevents the degradation of array performance due to mutual coupling effects and also reduces the array cost by employing less number of sensor elements compared to a half-wavelength spaced filled array. The origin of the concept for thinned arrays dates back to the work of Unz[1] in the 1950's. Ever since then, the thinned array has been widely investigated in such areas as radar[2, 3], astronomy[4] and satellite communication[5]. It is known that when the number of elements in a filled array is reduced, the sidelobe performance is degraded due to the less of degrees of freedom to control the beam pattern. The problem in the thinned array is how to synthesize an optimum pattern with reduced number of elements which satisfies given design specifications while the performance is comparable to that of the filled array. A linear sensor array is shown in Fig.1.

In this paper, it is concerned that the thinned array is designed such that the sidelobe level is equalized in a Dolph-Chebyshev sense to counteract the interferences uniformly distributed over the array visual range. A certain set of optimum element spacings is found by an iterative perturbation of element spacings with uniform

array weights. A conventional perturbation method[6] is modified such that an optimum pattern for the thinned array is efficiently synthesized by locating the sidelobes numerically.

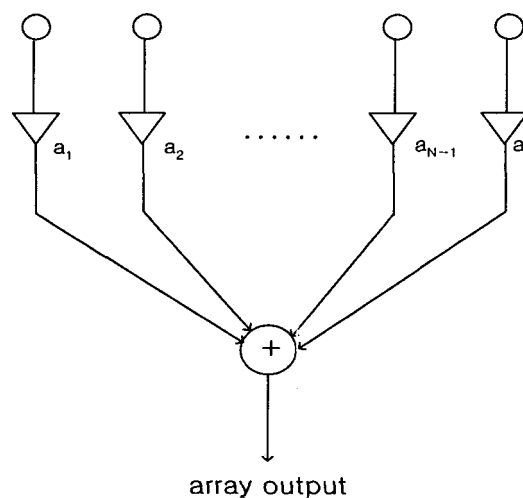

Figure 1. Linear sensor array.

## II. Perturbation Method

One way to find a certain set of element spacings such that the sidelobe level of the thinned array factor is equalized as in the pattern of Dolph-Chebyshev filled array is to reduce the level of the higher sidelobes by sacrificing lower sidelobes as in the perturbation method proposed by M. T. Ma [6].

The perturbation method equalizes the sidelobe levels iteratively using an arbitrary initial pattern by perturbing the element spacings. To this end, either the element

\* Department of Electrical Eng., University of Incheon

Manuscript Received :

spacing or the current or both may be perturbed. From a practical point of view, we consider the case of perturbing the element spacing while maintaining the uniform current.

The array factor of a symmetric thinned array of  $2N_1$  elements is given by

$$H(\omega) = 2 \sum_{n=1}^{N_1} a_n \cos(\omega D_n) \quad (1)$$

where the current  $a_n$  is assumed to be uniform. Normalizing the current, we get

$$H(\omega) = \frac{1}{N_1} \sum_{n=1}^{N_1} \cos(\omega D_n) \quad (2)$$

Suppose that  $L$  sidelobes are located at  $\omega_i$ ,  $1 \leq i \leq L$  and the corresponding sidelobe levels are  $H(\omega_i) = \epsilon_i$ . Since the derivative of  $H(\omega)$  with respect to  $\omega$  at each sidelobe  $\omega_i$  will be zero, we have the following equations

$$\epsilon_i = \frac{1}{N_1} \sum_{n=1}^{N_1} \cos(\omega_i D_n), \quad 1 \leq i \leq L \quad (3)$$

$$\sum_{n=1}^{N_1} D_n \sin(\omega_i D_n) = 0, \quad 1 \leq i \leq L \quad (4)$$

Note that for the linear equations in (3) and (4), the solution for  $\omega_i$  and  $D_n$  will be unique only when the  $L = N_1$ , i.e., the number of sidelobes to be controlled is the same as the number of the unknown element spacings.

In the perturbation method, the element spacing  $D_n$  is perturbed iteratively such that  $N_1$  sidelobes get closer to a specified threshold level. With an initial choice of spacings  $D_n^0$  the corresponding  $\omega_i^0$  and  $\epsilon_i^0$  of the  $N_1$  highest sidelobes are determined. If the initial spacing is perturbed by  $\Delta D_n^0$  we have

$$D_n^1 = D_n^0 + \Delta D_n^0 \quad (5)$$

As a result, the positions and the levels of these  $N_1$  sidelobes change accordingly as follows.

$$\omega_i^1 = \omega_i^0 + \Delta \omega_i^0 \quad (6)$$

$$\epsilon_i^1 = \epsilon_i^0 + \Delta \epsilon_i^0 \quad (7)$$

Then, (3) and (4) become

$$\epsilon_i^1 = \frac{1}{N_1} \sum_{n=1}^{N_1} \cos((\omega_i^0 + \Delta \omega_i^0)(D_n^0 + \Delta D_n^0)), \quad 1 \leq i \leq L \quad (8)$$

$$\sum_{n=1}^{N_1} (D_n^0 + \Delta D_n^0) \sin((\omega_i^0 + \Delta \omega_i^0)(D_n^0 + \Delta D_n^0)) = 0, \quad 1 \leq i \leq L \quad (9)$$

Assuming small perturbations, we use the following approximations in (8) and (9)

$$\begin{aligned} \sin(D_n^0 \Delta \omega_i^0 + \omega_i^0 \Delta D_n^0 + \Delta D_n^0 \Delta \omega_i^0) \\ \approx D_n^0 \Delta \omega_i^0 + \omega_i^0 \Delta D_n^0 \end{aligned} \quad (10)$$

$$\cos(D_n^0 \Delta \omega_i^0 + \omega_i^0 \Delta D_n^0 + \Delta D_n^0 \Delta \omega_i^0) \approx 1 \quad (11)$$

Then we have

$$\Delta \epsilon_i^1 = -\frac{1}{N_1} \omega_i^0 \sum_{n=1}^{N_1} \Delta D_n^0 \sin(\omega_i^0 D_n^0) \quad (12)$$

$$\begin{aligned} \Delta \omega_i^0 \sum_{n=1}^{N_1} (D_n^0)^2 \cos(\omega_i^0 D_n^0) + \omega_i^0 \sum_{n=1}^{N_1} D_n^0 \Delta D_n^0 \cos(\omega_i^0 D_n^0) \\ + \sum_{n=1}^{N_1} \Delta D_n^0 \sin(\omega_i^0 D_n^0) = 0 \end{aligned} \quad (13)$$

Assuming that  $\Delta \epsilon_i$  is a small fraction of the difference of the actual sidelobe level of the  $i$ th sidelobe and a specified threshold level, which is set as a desired equalized sidelobe level, we perturb the spacings iteratively using a linear programming approach until all the sidelobes are equalized. It is to be noted that to ensure unique solutions of  $\Delta D_n$  and  $\Delta \omega_i$  at each iteration, the number of sidelobes  $L$  to be controlled should be equal to the number of element spacings  $N_1$ . Also, the threshold level needs to be chosen very carefully such that it is a median of all the sidelobe levels. Thus, the higher sidelobes decrease by sacrificing the lower sidelobes. If the threshold level is set too low, there may be no solution to the linear equations of (12) or the resulting pattern will be degraded.

Consider a symmetric 20-element filled array with initial element spacing uniform. The number of sidelobes on one side of the mainbeam is nine and the number of unknown spacings is nine with the two end elements fixed. The initial and synthesized beam patterns are shown in Fig. 2. The initial and final spacings are shown of Table 1. It is shown that the levels of the first three higher sidelobes are reduced by sacrificing the

lower ones away from the mainbeam. The mainbeam width becomes slightly broader. Also some of the spacings between two neighboring elements are much less than half wavelength. Thus mutual coupling effects are significant for the case of antenna elements. Since only  $N_1$  sidelobes are controlled in the perturbation method, if a pattern with more than  $N_1$  sidelobes is used as the initial pattern, some of the sidelobes can not be controlled. For example, if a 20-element symmetric thinned array with inter-element spacing  $0.8\lambda$  is used, the initial pattern has 20 sidelobes. Thus 11 sidelobes will be out of control. The initial and final patterns are compared in Fig. 3 and the corresponding spacings are listed in Table 2. It is observed that only 9 sidelobes are equalized while other sidelobes are not controlled.

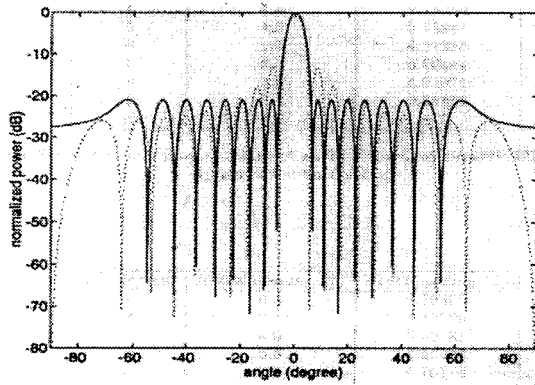

Figure 2. Beam pattern of a 20-element symmetric array: equalized pattern (solid line); initial pattern (dotted line).

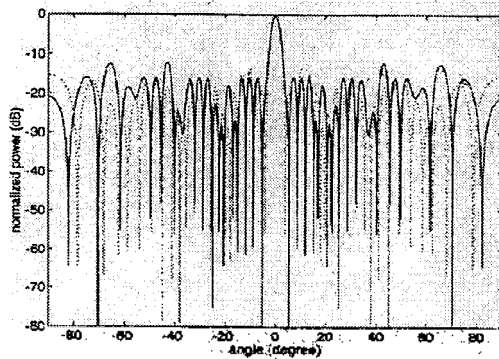

Figure 3. Comparison of the initial (dotted line) and equalized (solid line) patterns of a 20-element symmetric thinned array.

Table 1. Initial and final spacings of a 20-element symmetric filled array by perturbation method.

nth element	Initial spacing( $\lambda/2$ )	Final spacing( $\lambda/2$ )
1	0.5	0.40077
2	1.5	1.15678
3	2.5	2.03846
4	3.5	2.75360
5	4.5	3.75888
6	5.5	4.57215
7	6.5	5.70444
8	7.5	6.81071
9	8.5	8.35283
10	9.5	9.5

Table 2. Initial and final spacings of a 20-element symmetric thinned array by perturbation method.

nth element	Initial spacing( $\lambda/2$ )	Final spacing( $\lambda/2$ )
1	0.8	0.79395
2	2.4	2.17265
3	4.0	3.52181
4	5.6	4.52668
5	7.2	6.16170
6	8.8	7.77555
7	10.4	9.43360
8	12.0	10.90503
9	13.6	13.33368
10	21.85	21.85

From the above discussions, some drawbacks of the perturbation method have been observed.

1. Since the array should initially be equally spaced with  $0.5\lambda$  spacing to produce a pattern with the same number of sidelobes as the number of element spacings, some of the final spacings are less than half wavelength. As a result, the mutual coupling effects increase for the case of antenna arrays.
2. If the number of the sidelobes in the initial pattern is more than the number of element spacings, some of the sidelobes may not be controlled.

Therefore, the perturbation method is not suitable for the thinned array where the number of sidelobes is more than the number of element spacings to be determined. To overcome the shortcomings of the perturbation method, a modified perturbation method is proposed.

### III. Modified Perturbation Method

In the perturbation method, only the initially chosen sidelobes the number of which is equal to the number of element spacings to be determined are controlled during the entire perturbation process and other sidelobes are uncontrollable. Thus, if  $N_1$  maximum sidelobes are chosen and updated at each iteration instead of updating the initially chosen  $N_1$  sidelobes, we can prevent any sidelobes from being higher than the specified threshold level.

The basic idea of the modified perturbation method is that the locations of the new set of maximum sidelobes are found numerically at each iteration instead of calculating  $\Delta\omega_i$  using (13) in the conventional approach. Then the perturbation of the spacings is determined by (12) based on the numerically found  $\omega_p$ .

Fig. 4 shows the equalized beam pattern of a 41-element thinned array by using sub-optimal spacings from an exponentially weighted least square method as the initial spacings. It is observed that most sidelobes are equalized to approximately -20dB. Table 3 lists the initial spacings from the exponentially weighted least square method and the final spacings from the modified perturbation method. From the table, we can see that all the final spacings are greater than half wavelength. This is due to the fact that the initial spacings which were obtained by the least square method are very sparse due to the reduced number of elements. It is to be noted that even though the number of elements of the filled array has been reduced by 60% (from 101 elements to 41 elements), the pattern is still acceptable.

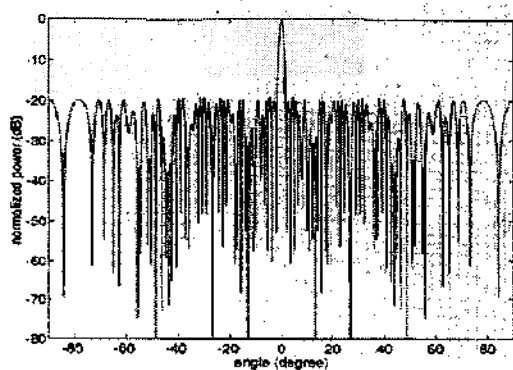

Figure 4. Equalized pattern of a 41-element thinned array by modified perturbation method.

To find the array performance with even fewer elements, we use the pattern optimized by the exponentially weighted least square method with a 31-element thinned array as

the initial pattern. The beam pattern optimized by the modified perturbation method is shown in Fig. 5, where the sidelobes are equalized at about -15dB. The initial and final spacings are shown in Table 4. It is shown that all the element spacings are larger than half wavelength. It is found that if the threshold level is set too low, the sidelobes may not be equalized. This phenomenon becomes noticeable as the number of elements decreases.

Table 3. Initial and final spacings of a 41-element thinned array by modified perturbation method.

nth element	Initial spacing( $\lambda/2$ )	Final spacing( $\lambda/2$ )
0	0.0	0.0
1	1.39926	1.18173
2	2.86957	2.52091
3	4.31333	4.40371
4	5.71815	5.84733
5	7.21106	7.48044
6	8.75642	9.31627
7	10.26311	11.06781
8	11.77842	12.20355
9	13.41733	13.31907
10	15.18360	15.08453
11	17.01480	16.91031
12	18.89340	18.76788
13	20.78240	20.68640
14	22.68395	22.67668
15	24.59053	24.64881
16	26.50319	26.42777
17	28.43129	28.38276
18	30.43402	30.27465
19	34.17922	34.36531
20	50.0	50.0

Table 4. Initial and final spacings of a 31-element thinned array by modified perturbation method.

nth element	Initial spacing( $\lambda/2$ )	Final spacing( $\lambda/2$ )
0	0.0	0.0
1	1.64216	0.99767
2	3.25255	2.36712
3	4.86178	4.12875
4	6.54008	6.27993
5	8.3035	7.78451
6	10.1319	9.73259
7	11.99811	11.70361
8	13.88142	13.34557
9	15.77871	15.12941
10	17.67951	18.15315
11	19.58535	19.03433
12	21.5067	21.45972
13	23.46473	23.26545
14	25.57514	25.70963
15	50.0	50.0

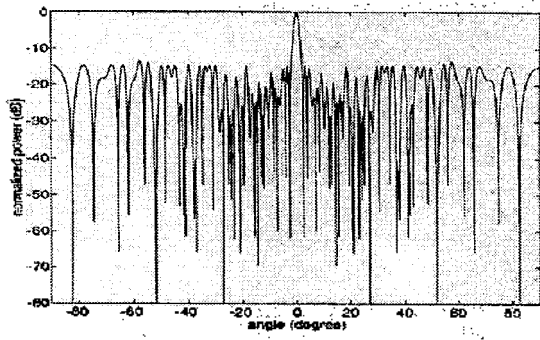

Figure 5. Beam pattern of a 31-element thinned array by modified perturbation method.

#### IV. Least Square Approach

In the modified perturbation algorithm, the number of unknown spacings should be exactly the same as the number of sidelobes that are involved during each iteration. If the number of sidelobes that are involved in the perturbation process is more than the number of unknown spacings, (12) will become an overdetermined system of linear equations whose solution may be obtained by a least square approach. Assuming the number of sidelobes involved and the number of unknown spacings are  $L$  and  $N_1$ , respectively, and  $L > N_1$ , we have (12) in matrix form as

$$A\Delta d = \Delta \varepsilon \quad (14)$$

where  $A$  is a  $L \times N_1$  matrix

$$\begin{pmatrix} \frac{1}{N_1} \omega_1^0 \sin(\omega_1^i D_1^i) & \frac{1}{N_1} \omega_1^0 \sin(\omega_1^i D_2^i) & \dots & \frac{1}{N_1} \omega_1^0 \sin(\omega_1^i D_{N_1}^i) \\ \frac{1}{N_1} \omega_2^0 \sin(\omega_2^i D_1^i) & \frac{1}{N_1} \omega_2^0 \sin(\omega_2^i D_2^i) & \dots & \frac{1}{N_1} \omega_2^0 \sin(\omega_2^i D_{N_1}^i) \\ \dots & \dots & \dots & \dots \\ \frac{1}{N_1} \omega_L^0 \sin(\omega_L^i D_1^i) & \frac{1}{N_1} \omega_L^0 \sin(\omega_L^i D_2^i) & \dots & \frac{1}{N_1} \omega_L^0 \sin(\omega_L^i D_{N_1}^i) \end{pmatrix} \quad (15)$$

$$\Delta d = [\Delta D_1^i \ \Delta D_2^i \ \dots \ \Delta D_{N_1}^i]^T \quad (16)$$

$$\Delta \varepsilon = [\Delta \varepsilon_1^{i+1} \ \Delta \varepsilon_2^{i+1} \ \dots \ \Delta \varepsilon_L^{i+1}]^T \quad (17)$$

where  $i$  is an iteration index. For an overdetermined system, we can apply the generalized inverse method to find the solution in the least square sense. Multiplying both sides of (14) by  $A^T$  and assuming that  $(A^T A)^{-1}$  exists, we have the least square solution as

$$\Delta d = (A^T A)^{-1} A^T \Delta \varepsilon \quad (18)$$

In (18),  $\Delta d$  is the coordinate vector with respect to the column vectors of  $A$  when  $\Delta \varepsilon$  is orthogonally projected onto the column space of  $A$ . It is assumed that  $D_n$ ,  $1 \leq n \leq N_1$  are distinct and thus the column vectors of  $A$  are linearly independent.

Using (18), we can find  $\Delta D_n$ ,  $1 \leq n \leq N_1$  at each iteration. Fig. 6 shows the beam pattern optimized for the 31-element symmetric thinned array where the number of the unknown spacings is 14 and the number of sidelobes involved is 16. The sidelobe level is reduced compared to that of the modified perturbation approach while the mainbeam width gets a little broader. However, more sidelobes involved does not necessarily improve the sidelobe performance. The beam pattern with 20 sidelobes involved is shown in Fig. 7. The sidelobe performance is found to be poorer compared with Fig. 6.

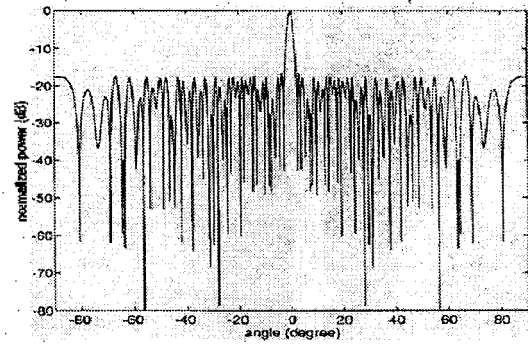

Figure 6. Beam pattern of a 31-element symmetric thinned array by Least square approach with 16 sidelobes.

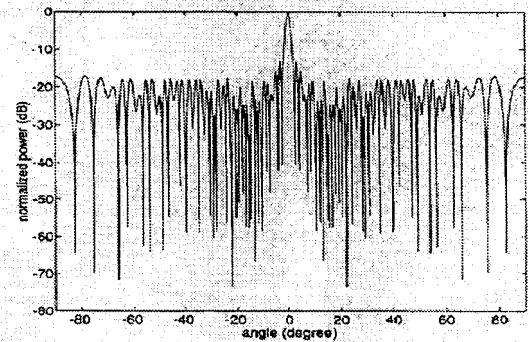

Figure 7. Beam pattern of a 31-element symmetric thinned array by generalized inverse approach with 20 sidelobes.

#### V. Conclusions

A least square approach was proposed for synthesis of an optimal beam pattern with uniform sidelobes in a

thinned sensor array to improve the array performance. In the modified perturbation method, the optimum element spacing is obtained by iteratively solving a set of linear equations corresponding to the number of maximum sidelobes which is equal to the number of element spacings.

Since the number of sidelobes is greater than that of element spacings in the thinned array, the least square method may be employed in finding an optimal solution. A better performance is expected in the least square selection in the sense that more sidelobes are involved in the optimization process compared with the modified perturbation method.

The simulation results demonstrate that the least square approach performs better than the modified perturbation method even though the array performance depends on the number of sidelobes involved.

### References

1. H. Unz, "Linear arrays with arbitrarily distributed elements," *Electronic Res. Lab., Univ. of California, Berkeley, Rept. Ser. no. 60, Issue no. 168, Nov. 2, 1956.*
2. W. Doyle, "On approximation linear array factors," *The RAND Corporation, Memorandum RM-3530-PR, Feb. 1963.*
3. J. L. Allen, "Array antennas: new applications for old techniques," *IEEE Spectrum*, pp. 115-130, Nov. 1964.
4. G. W. Swenson, Jr and Y. T. Lo, "The University of Illinois radio telescope," *IRE Trans. Antennas Propagat.*, pp. 9-16, Jan. 1961.
5. J. T. Mayhan, "Thinned array configuration for use with satellite-based adaptive antennas," *IEEE Trans. Antennas Propagat.*, vol. AP-28, pp. 846-856, Nov. 1980.
6. M. T. Ma, "Note on nonuniformly spaced arrays," *IEEE Trans. Antennas Propagat.*, pp. 508-509, Jan. 1973.

#### ▲ Byoun-Kun Chang

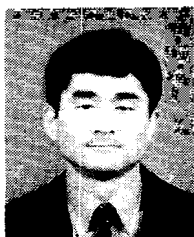

Byong Kun Chang was born in Pusan, Korea. He received the B.E. degree in electronic engineering from Yonsei University in 1975, the M.S. degree in electrical engineering and computer engineering from the University of Iowa, Iowa City, Iowa, in 1985, and the Ph.D. degree in electrical and computer engineering from the University of New Mexico, Albuquerque, New Mexico, U.S.A., in 1991. He was with the Department of Electrical Engineering, University

of Nevada, Reno, Nevada from 1990 to 1994 as an Assistant Professor. He is currently an Associate Professor in the Department of Electrical Engineering, University of Inchon, Inchon, Korea. His research interests are in array signal processing and adaptive signal processing.