

An Experimental Study of Backwater Effects Caused by the Covered Reach of Urban Streams

Yoon, Yong Nam* · Ahn, Jae Hyun** · Kim, Jin Kwan***

ABSTRACT : The hydraulics of flow within the covered reach of urban streams is very complicated due to the accumulation and interference effect of eddies around the multiple piers supporting the covering slab. An extensive experimental study is done to quantitatively estimate the backwater rise effect caused by various arrays of multiple piers. The factors governing the backwater rise are found out to be the contraction ratio due to the piers, Froude number of the flow, longitudinal pier spacing, and the length of the covered reach. For a single section of lateral pier arrays the effect of contraction ratio and Froude number on the backwater rise is analyzed and a multiple regression equation derived. The effect of multiple piers, arrayed in both lateral and longitudinal directions, on the backwater rise is analyzed in terms of the contraction ratio, Froude number, longitudinal pier spacing and the total length of the covered reach. A multiple regression equation for the backwater rise estimation is proposed based on the experimental data collected in this study.

1. Introduction

In many developing countries a part of the urban streams is often covered by a concrete or asphalt slab for driveways, parking spaces or other land use purposes. The concrete pier columns supporting the slab hinder the passage of flood water during the rainy season accelerating flood risks in the densely developed urban area.

The backwater effect of bridge piers at a river cross section has long been studied experimentally as well as analytically (D' Aubuisson, 1840 ; Negler, 1918; Rehbock, 1919 ; Yarnell, 1934 ; Eichert and Peters, 1970 ; HEC, 1982). However, the effect of multiple piers, closely arrayed in the lateral and longitudinal directions, on the flood water level has not been well studied. Therefore, a series of laboratory experiments was made for various arrays of multiple columns support-

* Professor, Korea University, Dept. of Civ. Engrg. Anamdong, Seoul, Korea

** Grad. Res. Asst., Korea University, Dept. of Civ. Engrg. Anamdong, Seoul, Korea

*** Hydraulic engineer, Korea Engineering consultant, Seoul, Korea

ing the slab covering the stream, and then results are analyzed and compared with those estimated by the existing methods of backwater computation.

2. Formulas for Backwater Rise Caused by Piers

Among the existing formulas the most popular ones are those of D'Aubuisson and Yarnell. The nondimensional form of D'Aubuisson formula (YOON, 1995) can expressed as follows(Fig. 1) :

$$\frac{\Delta y}{y_3} = \frac{y_1 - y_3}{y_3} = 0.5 \left(\frac{Fr_3}{K_A} \right)^2 \left[\left(\frac{B_3}{b_2} \right)^2 - 1 \right] \tag{1}$$

where Δy =backwater rise due to pier ; y_3 =water depth at downstream section; Fr_3 =Froude number at downstream section, K_A =contraction loss coefficient depending on contraction ratio and pier shape ($K_A=0.96-1.31$; Yarnell, 1934) ; B_3 =width of stream channel ; b_2 =net width of stream at pier section ($b_2=B_3-nd$; n =number of lateral piers at pier section ; d =diameter of a pier).

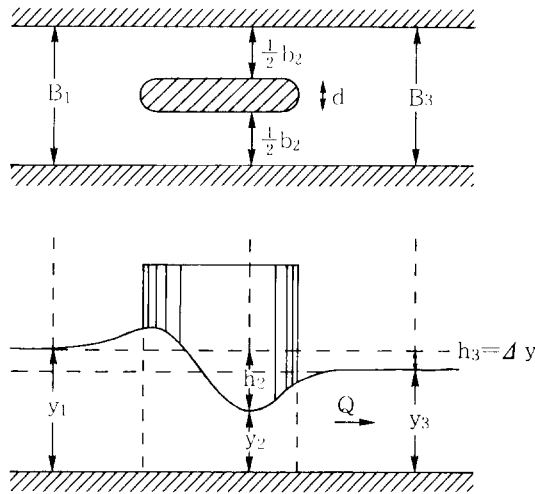

Fig. 1 Flow through a Single Pier

Yarnell(1934) made extensive studies on the flow between bridge piers through laboratory experiments and the nondimensional form of the Yarnell formula used in HEC-2, water surface profiles (HEC, 1982) can expressed as follows(Fig. 1) :

$$\frac{\Delta y}{y_3} = \frac{y_1 - y_3}{y_3} = K [K + 5 Fr_3^2 - 0.6] [\alpha + 15\alpha^4] Fr_3^2 \tag{2}$$

where K =contraction loss coefficient depending on the pier shape($K=0.90-1.25$; Yarnell 1934),

α =contraction ratio of the pier section with respect to the downstream section($\alpha = nd / B_3 = 1 - b_2 / B_3$).

3. Experimentation

A series of laboratory experiments are run in a $30^{cm} \times 30^{cm} \times 15^m$ sloping open channel with a tail gate for flow depth control. For model piers stainless steel cylinders of 15^{mm} diameter are set up both in cross-sectional and longitudinal directions.

The laboratory flume used in this study is schematically shown in Fig. 2. The discharge in the flume is set up based on the predetermined flow rating by adjusting a valve located near the end of feeding pipe from the head tank and the flow depth on a channel slope is controlled by the tail gate. With a lateral and longitudinal array of piers as shown in Fig. 3 the depths downstream and upstream of a pier is measured by a point gauge.

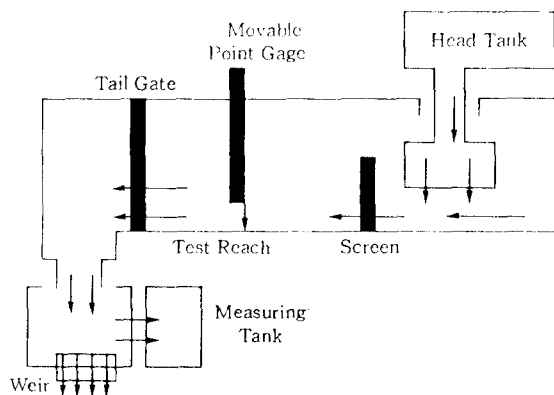

Fig. 2 Schematic Diagram of Laboratory Flume System

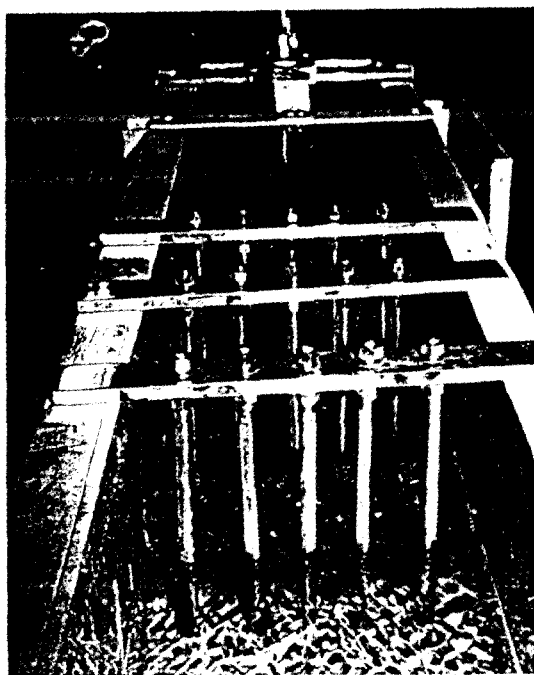

Fig. 3 Sample Array of Multiple Piers

4. Functional Relations among the Parameters Involved

The backwater rise Δy in Fig. 1 can be expressed as a function of the flow characteristics and the characteristic parameters of the multiple pier arrangement in the channel, i.e.,

$$\Delta y = \Phi(y_3, V_3, g, B_3, d, NP, SPL, LP) \tag{3}$$

where V_3 =mean velocity at downstream section, g =gravitational acceleration, NP =number of piers at the pier section, SPL =longitudinal spacing of piers, LP =total length of the covered reach (Fig. 4).

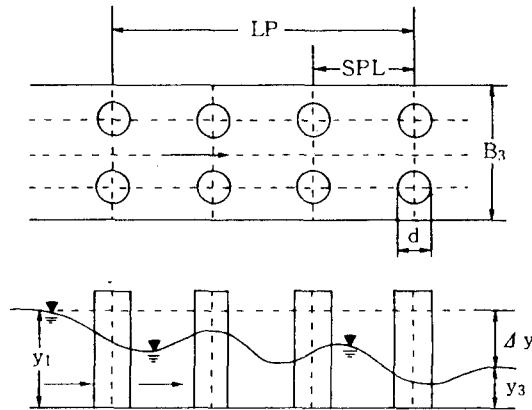

Fig. 4 Backwater Rise due to Multiple Piers

The dimensional analysis based on Eq. (3) gives the following nondimensional relations.

$$\frac{\Delta y}{y_3} = \Phi' \left(\frac{V_3}{\sqrt{g y_3}}, \frac{b_2}{B_3}, \frac{SPL}{d}, \frac{LP}{SPL}, NP \right) \tag{4}$$

where $V_3 / \sqrt{g y_3} = F_{r3}$ Froude number at downstream section, $b_2 / B_3 = 1 - \alpha$, $SPL / d = SP$ = longitudinal pier spacing in terms of pier diameter, LP / SPL = covered reach length in terms of pier spacing.

The nondimensional parameters b_2 / B_3 and NP in Eq. (4) can be explained by the contraction ratio α since $\alpha = NP \times d / B_3 = 1 - b_2 / B_3$. Therefore, Eq.(4) can be reduced to

$$\frac{\Delta y}{y_3} = \Phi''(F_{r3}, \alpha, SP, NPL) \tag{5}$$

where NPL is taken as $(LP / SPL) + 1$, the number of pier sections in the longitudinal direction over the covered reach.

5. Experimental Runs

In order to study the functional relations shown in Eq. (5), the Froude number of the flow is

limited by the tail gate operation within the range 0.1-0.6 as usually observed in small urban streams, keeping the channel slopes at 0.001-0.003 and constant flow rate of 12 /sec. To investigate the effect of number of piers in lateral direction, the number of piers and pier spacing in longitudinal direction the pier arrangements in Table 1 are used in the experiments.

Since the distribution of piers with the same contraction ratio at a section affects the magnitude of backwater rise, three different distributions shown in Fig. 5 are tested. The centered distribution stands for the case of HEC-2 backwater computation. The uniform and skewed distribution stands for the full and partial covered reach of urban streams.

Table 1. Ranges of Nondimensional Parameters

NP	1	2	3	4	5	6	7	8
α	5	10	15	20	25	30	35	40
SP	3	4	5	6	7	8	9	11
NPL	1	2	3	4	5	-	-	-

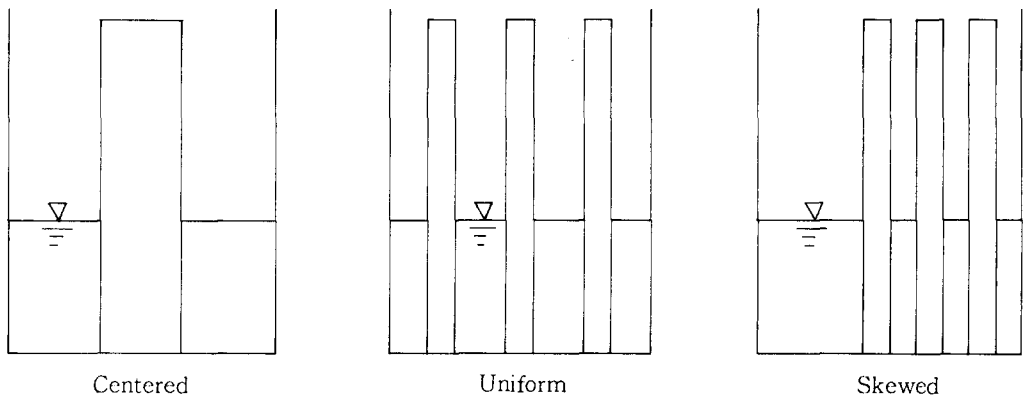

Fig. 5. Types of Lateral Pier Distribution

5. Depth Corrections for the Side Wall Effect of Flume

The depth measured in each of the experimental runs has to be corrected to take care of the friction effect of the side channel in laboratory flume, for which Einstein (1942), Johnson (1942), Vanoni and Brooks (1957) methods have often been used. In this study the Vanoni and Brooks method of correction for a rectangular channel of width B is employed, the wall friction factor being estimated by Rijn (1981) formula.

6. Results and Discussions

The effect of piers at a bridge section has been studied long. However, studies on the interfering effect between adjacent piers in both lateral and longitudinal directions are very few. With the data collected through extensive experimental runs in the present study the rate of increases in depths due to various arrays of multiple piers is measured and the characteristics of backwater rise are investigated. The rate of backwater rise has also been correlated with the parameters governing the flow characteristics affected by multiple piers.

6.1 Backwater Rise due to a Single Lateral Array of Piers

As the number of piers increases at a pier section the contraction ratio(α) increases which accelerates the backwater effect. Fig. 6 shows that the relative backwater rise increases with the increases in contraction ratio, at all Froude number. D' Aubuisson formula fits closely the experimental relation between $\Delta y / y_3$ vs α , whereas the Yarnell equation with $K=1.05$ gives a smaller backwater rise at low Froude numbers ($Fr_3 \leq 0.30$), but it estimates larger rises at higher Froude number ($Fr_3 > 0.30$).

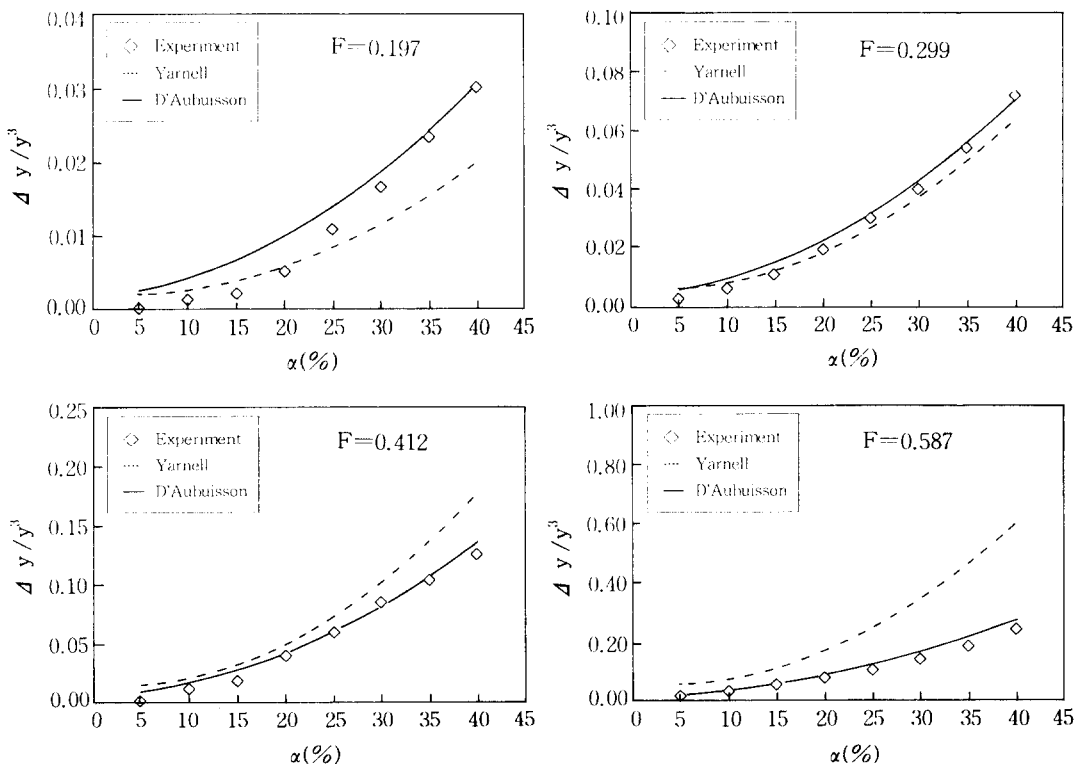

Fig. 6 Relative Backwater Rise Caused by an Increasing Number of Piers at a Single Section

Fig. 7 shows the effect of pier distribution on the $\Delta y/y_3-\alpha$ relation at a single pier section. As can be seen in Fig. 7 the backwater effect becomes larger in the order of uniform, centered and skewed distribution. D'Aubuisson formula fits well for the case of uniform pier distribution, whereas Yarnell formula approximates better for the centered distribution.

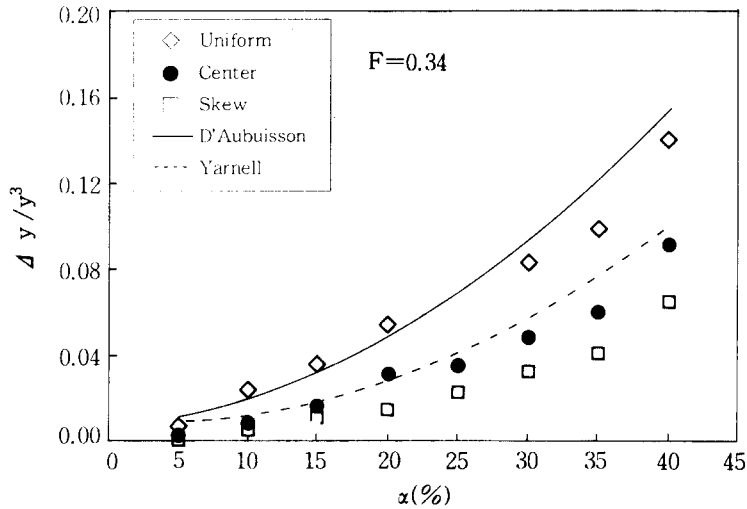

Fig. 7 Relative Backwater Rise for different Lateral Distribution of Piers at a Single Section

The relationship $\Delta y/y_3$ with Froude number and contraction ratio (α) is shown in Fig. 8. It is clear from Fig. 8 that the relative backwater rise increases with the increasing Froude number and contraction ratio.

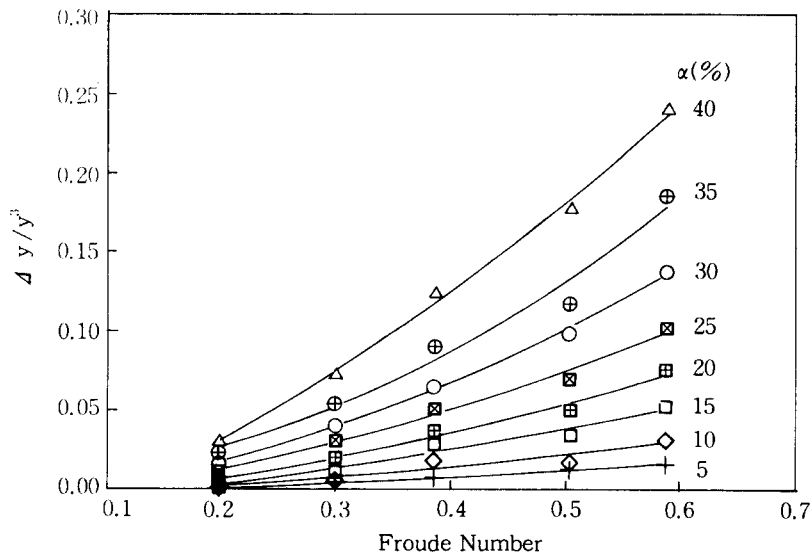

Fig. 8 Relative Backwater Rise - Froude Number - Contraction Ratio Relation for a Single Lateral Array of Piers

6.2 Backwater Rise due to Lateral and Longitudinal Array of Piers

When the piers arrayed in longitudinal direction as well as in lateral direction the backwater effect progressively moves toward the upstream direction and accumulates with some flow interferences among individual piers, resulting a very complicated flow field in the covered reach. Fig. 9 and 10 Show $\Delta y/y_3-\alpha$ relations with SP=5 for several Froude numbers of the flow. It can be seen that $\Delta y/y_3$ increases rapidly with the contraction ratio as the number (NPL) of longitudinal pier section increases. The rate of increases also becomes larger with Froude number at a constant SP=5.

In Fig. 9 the relations by Yarnell formula are compared with the experimental results. For a small Froude number ($Fr_3 < 0.3$) Yarnell formula underestimates the relative backwater rise at a fixed contraction ratio, whereas it overestimates for higher Froude numbers. On the other hand, D'Aubuisson formula estimated the relations for higher Froude numbers ($Fr_3 > 0.3$) closely as can be seen in Fig. 10.

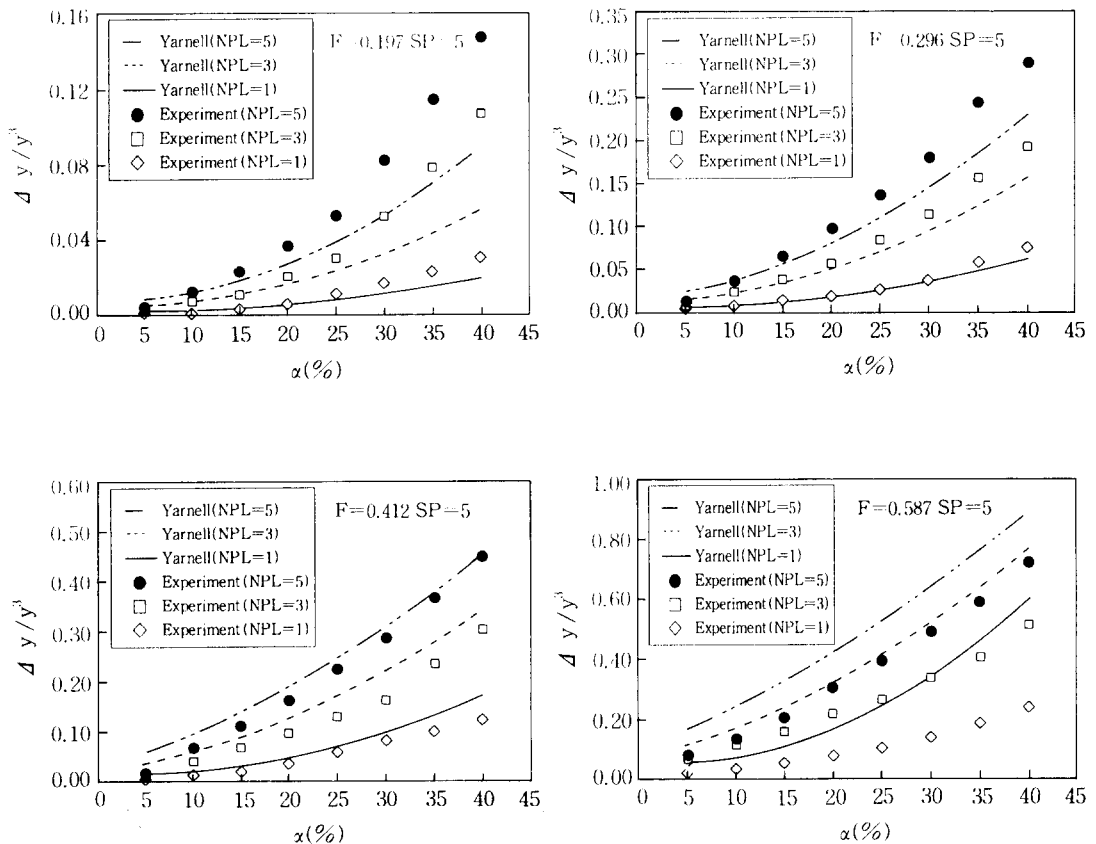

Fig. 9 comparison of Experimental Results with Yarnell Formula

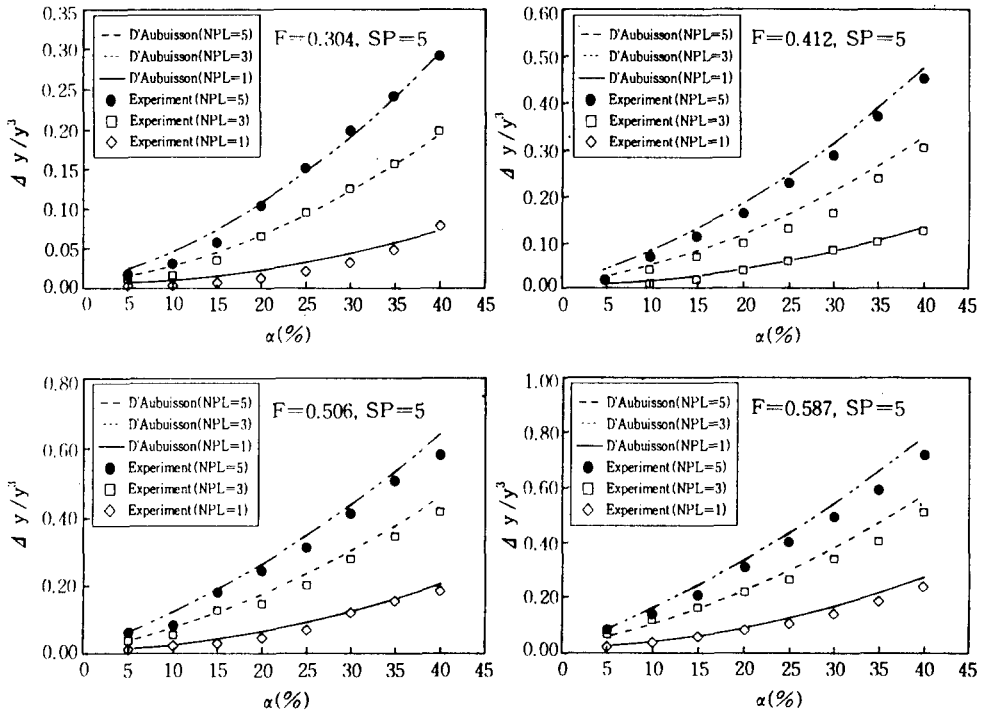

Fig.10 Comparison of Experimental Results with D' Aubuisson Formula

6.3 Relative Effect of number and Spacing of Longitudinal Piers

In order to investigate the relative effect of the number and spacing of longitudinal piers in flow direction on the backwater rise the data are plotted as in Fig.11. From Fig.11 the effect of longitudinal spacing is seen to be not as critical on the backwater rise as the number of longitudinal pier section at both Froude numbers.

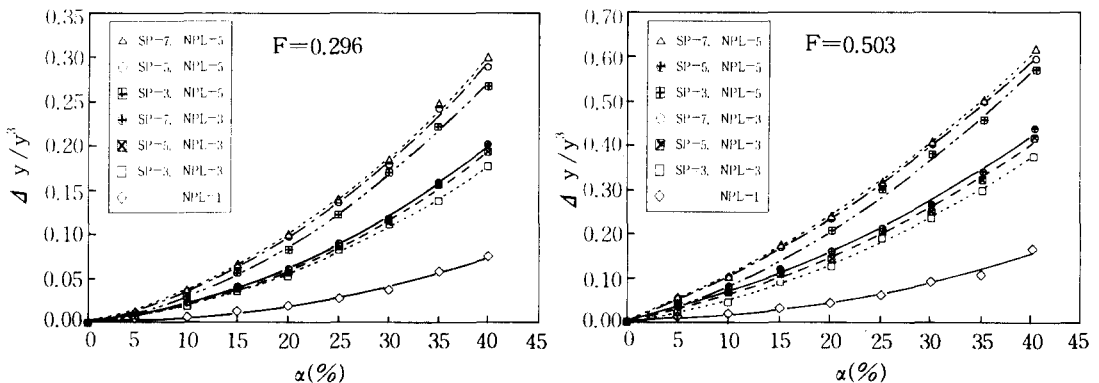

Fig. 11. Relative Backwater Rise-Contraction Ratio Relations for Varying Longitudinal Spacing and Number of Piers

The effect of longitudinal pier spacing on the backwater rise is also shown in Fig.12 for two Froude numbers and NPL=3. The relative backwater rise increases as pier spacing increases up to SP=5~7 and it becomes almost constant regardless of Froude number and pier spacing. It is speculated that the backwater rise stabilizes if the longitudinal pier spacing becomes larger than a certain limit beyond which the accumulation and interference effects of eddy flows around multiple piers vanish.

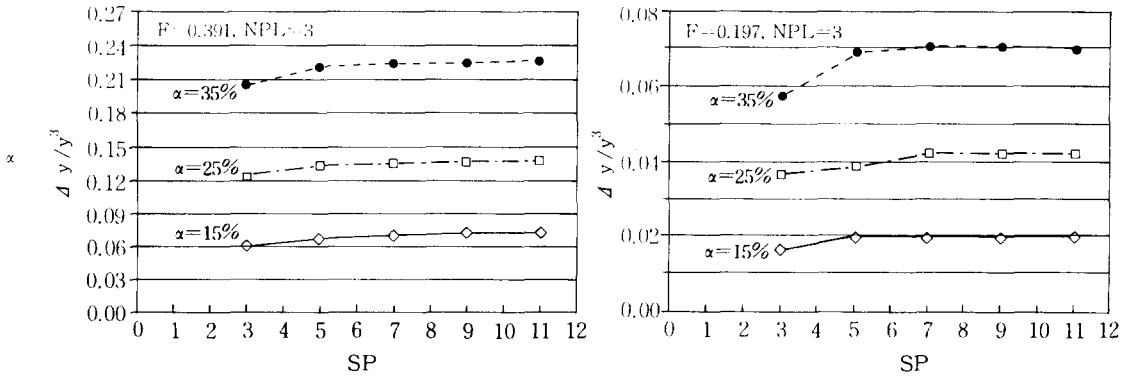

Fig.12 Relative Backwater Rise-Longitudinal Pier Spacing Relationship

7. Proposed Formula for Backwater Rise Computation

Multiple regression analyses are made with the data collected in the present study in order to develop empirical formula for the estimation of backwater rise in the case of single pier section and of multiple pier section. For the single and multiple pier sections a total of 104 and 640 backwater depth data is, respectively, analyzed along with the characteristic data of flow and pier.

The derived formulas can be expressed as in the following :

For a single pier section reach :

$$\frac{\Delta y}{y_3} = 0.00225\alpha^{1.646} F_{r3}^{2.379} \tag{6}$$

For a longitudinal multiple pier section reach :

$$\frac{\Delta y}{y_3} = 0.00241\alpha^{1.452} F_{r3}^{2.056} NPL^{0.880} SP^{0.204} \tag{7}$$

8. Conclusion

This experimental study is carried out to investigate the effect of multiple piers arrayed in lateral and longitudinal directions on the backwater rises within a covered reach of urban streams. The relative backwater rise is found to be highly dependent on the Froude number of the flow and contraction ratio of the pier section in the case of single pier section reach. For a longitudinal multiple pier section reach the additional parameters such as the number of pier sections and pier spacings in the reach, effect significantly effects on the backwater rise. In general, the backwater depth increases with the increasing contraction ratio, Froude number, and the number of piers within the covered reach. The pier spacing has a positive effect in increasing the backwater rise to a certain limit spacing beyond which the effect vanishes. Through a multiple regression analysis of the data obtained in this study an empirical formula is proposed for the backwater rise estimation in the case of a single pier section reach and a longitudinal multiple pier section reach, respectively.

Acknowledgement

This study was conducted as a research project supported by Korea Science and Engineering Foundation Research Grant 931-1200-025-2.

References

- D'Aubuisson, J. F. (1840) *Traite dhydraulique*, Pitois, Levrant & Cie, Paris.
- Eichert, B. S. and Peters, L. (1970), Computer determination of flow through bridges, *Journal of Hydraulics Div.*, ASCE, Vol. 96, No. HY7.
- Einstein, H. A. (1942) formulas for the transportation of ed load, *Transactions, ASCE*, vol. 107, Paper No. 2140.
- Hydrologic Engineering Center(1982), HEC-2, Water Surface Profiles, Users Manual, U. S. Army Corps of Engineers.
- ohnson, J. W.(1942), The importance of considering side-wall friction in bed load investigations, *Civil Engineering, ASCE*, Vol. 12, No. 6.
- Negler, F. A.(1918), Obstruction of bridge piers to the flow of water, *Transaction, ASCE*, Vol. 82.
- Rehbock, T.(1919) On the problem of bridge constriction, *Zentralblatt der bauverwaltung*, Vol. 39, No. 37.
- Rijn, L. C. van(1981), Entrainment of fine sand particles : Computation of bed load concentration and bed load transport, Research report S487-part I.

- Vanoni, V. A. and Brooks, N. H. (1957), Laboratory studies of the roughness and suspended load of alluvial streams, Sedimentation Lab. Report No. E68, California Institute of Technology, Pasadena, Calif.
- arnell, D. L. (1934), Bridge piers as channel obstructions, U. S. Department of Agriculture, Technical Bulletin, No. 442.