

로봇 시스템 동적 변수의 실용적인 추정 방법

A Practical Identification Method for Robot System Dynamic Parameters

金 成 權*
(Sungkwun Kim)

요 약

본 논문에서 로봇의 관성, 마찰등의 변수 추정을 위한 새로운 방법을 제시한다. 로봇의 동적 방정식에 있는 변수의 값은 로봇에 명령한 전압과 관절위치의 측정으로 추정할 수 있다. 먼저 로봇의 모터와 매니플레이터의 동적 모델을 유도하고, 오프 라인 변수추정 방법을 제시하였다. 동 방법을 미네소타 직접구동 로봇에 적용하여 동적 변수를 구하였다. 로봇의 이동 궤적에 대한 오차는 추정 한 변수를 사용했을때 현저하게 감소되었음을 보여 주었다.

Abstract- A practical method of identifying the inertial parameters, viscous friction and Coulomb friction of a robot is presented. The parameters in the dynamic equations of a robot are obtained from the measurements of the command voltage and the joint position of the robot. First, a dynamic model of the integrated system of the manipulator and motor is derived. An off-line parameter identification procedure is developed and applied to the University of Minnesota Direct Drive Robot. To evaluate the accuracy of the parameters the dynamic tracking of the robot was tested. The trajectory errors were significantly reduced when the identified dynamic parameters were used.

1. Introduction

An identification method of the parameters in the dynamic equations of a manipulator is presented using joint position displacement measuring for a given step input. The model-based control

schemes such as the computed torque and resolved acceleration[1, 2] controller has been shown to compensate for manipulator non-linearities of high speed robots. These control schemes depend on the accuracy of the dynamic parameters. The validity of this method is questionable when there is a significant difference between the computed torque model parameters and the actual robot dynamics. Therefore, precise parameter identification is essential for accurate robot control.

*正 會 員 : 三星電子(株) Robot自動化 개발 理事·
上博

接受日字 : 1990年 1月 29日

1次修正 : 1990年 6月 18日

Earlier work in identification of robot dynamics concentrated on estimating the mass of payload. Paul[3] presented two techniques for the manipulators at rest. The first method used the joint torques/forces, and the second method used a wrist torque/force sensor. Coiffet[4] extended this technique to also estimate the center of mass of the payload. By using special test torques and moving only one joint at a time, the moment of inertia of the payload can also be estimated. Atkeson, An and Hollerbach[5] have proposed an approach which uses a wrist torque/force sensor to estimate the inertial parameters of a manipulator. Their approach has also been extended to identify the inertial parameters of all links of a robot[5]. Khosla and Kanade [6] developed an algorithm to estimate the inertial parameters of a robot from the measurements of inputs (actuating torques/forces) and outputs(joint positions, velocities and accelerations). They formulated the robot dynamics so that the joint torques or wrist forces are expressed linearly in terms of the suitably selected set of link or load parameters. One major problem associated with their method is that joint acceleration has to be obtained by numerical differentiation of position or velocity signals. This introduces noise and affects the accuracy of the estimated parameters. Also there is no way to find the friction force.

A new method to identify the dynamic parameters of a robot is presented from the measurements of its inputs(command voltage) and only joint positions. A mathematical model is introduced from the integrated system of links and actuators. The solution of the model is obtained. The identification method developed is implemented on the University of Minnesota Direct Drive Arm[7-10].

2. Mathematical model for robot dynamic parameter identification

A permanent magnet AC synchronous motor(DC brushless motor) is considered. The electrical equation of a brushless DC motor is given by

$$V_i(t) = E_a(t) + R_a i_a(t) + L_a \frac{di_a(t)}{dt} \tag{1}$$

where V_i is the applied voltage to the armature terminals of a motor, i_a is the armature current, E_a is the induced back emf, R_a and L_a are the armature winding resistance and inductance, respectively.

The electromagnetic torque, T_{em} , and back emf, E_a , produced by the motor are expressed as

$$T_{em}(t) = K_t i_a(t) \tag{2}$$

$$E_a(t) = K_e \omega(t) \tag{3}$$

where K_t and K_e are the motor constant and back emf constant, respectively. ω is the angular velocity of the shaft.

The above equations can be combined into

$$V_i(t) = K_e \omega(t) + R_a \frac{T_{em}(t)}{K_t} + \frac{L_a}{K_t} \frac{dT_{em}(t)}{dt} \tag{4}$$

In general, the armature inductance, L_a , in a brushless torque motor is low enough so the amplifiers can be considered as current sources. The resistance of the motor armature is the dominant sources of impedance. This allows simplification of equation(4) as follows.

$$V_i(t) = K_e \omega(t) + R_a \frac{T_{em}(t)}{K_t} \tag{5}$$

The arbitrary load requires a load torque, which the motor must provide :

$$T_{em}(t) = T_{load}(t) \tag{6}$$

where the load torque, $T_{load}(t)$, is the sum of the joint torque, $\tau(t)$, and friction torque $T_f(t)$.

The load torque, $T_{load}(t)$, can be considered as the sum of inertial torque, T_i , friction torque, T_f , and explicit load torque, T_L :

$$T_{load}(t) = T_i(t) + T_f(t) + T_L(t) \tag{7}$$

For integrating the motor dynamics with the

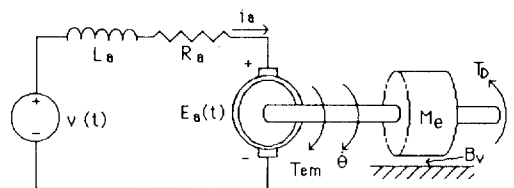

Fig. 1 Integrated system for a motor and its load

manipulator dynamics and friction, a convenient approach is to view each joint motor as a subsystem with these systems interconnected by disturbance torques. The inertial torque required by the combination of the motor and load inertia at joint i can be expressed as

$$T_{fi}(t) = \{M_{mi} + M_{ii}[\theta(t)]\}\ddot{\theta}_i(t) = M_{ei}[\theta(t)]\ddot{\theta}_i(t) \tag{8}$$

where M_{mi} denotes the combined moment of inertia of motor drive shaft and rotor assembly, and $M_{ii}[\theta(t)]$ is the effective inertia of joint i , which is the i -th diagonal element of matrix, $M[\theta(t)]$, and note that $M_{ei}[\theta(t)] = M_{mi} + M_{ii}[\theta(t)]$.

Friction torque is given by

$$T_{fi}(t) = B_{vi}\dot{\theta}_i(t) + T_{nfi}(t) \tag{9}$$

where B_{vi} is the combined viscous friction coefficient of the motor shaft and joint i , and T_{nfi} is nonlinear friction torques for joint i (Coulomb and stiction).

The explicit load torque, T_L , can be expressed as

$$T_{Li}(t) = \sum_{j=i}^n M_{ij}[\theta(t)]\ddot{\theta}_j(t) + C_i[\theta(t), \dot{\theta}(t)] \tag{10}$$

where $M_{ij}[\theta(t)]$ is (i, j) -th element of matrix $M[\theta(t)]$ and $C_i[\theta(t), \dot{\theta}(t)]$ denotes the i -th element of vector of the centrifugal, Coriolis, and gravity forces.

Substituting equations (8) through (10) into (7) yields

$$T_{loadi}(t) = M_{ei}[\theta(t)]\ddot{\theta}_i(t) + B_{vi}\dot{\theta}_i(t) + T_{Di}(t) \tag{11}$$

where $T_{Di}(t) = T_{Li}(t) + T_{nfi}(t)$. Since the load torque consists of inertial, friction terms, and disturbance load, the integrated dynamic equation of a manipulator from equations (5) and (11) is given by

$$V_{ii}(t) = K_{ei}\theta_i(t) + \{M_{ei}[\theta(t)]\}\ddot{\theta}_i(t) + B_{vi}\dot{\theta}_i(t) + T_{Di}(t) R_{ai}/K_{ti} \tag{12}$$

Eliminating the subscript “ i ”, equation (12) for an individual joint can be simplified as

$$\ddot{\theta}(t) + \frac{1}{M_e[\theta(t)]} \left(B_v + \frac{K_e K_t}{R_a} \right) \dot{\theta}(t) = \frac{1}{M_e[\theta(t)]} \left(V_t(t) \frac{K_t}{R_a} - T_D(t) \right) \tag{13}$$

where M_e is the combined moment of the inertia of the motor rotor, shaft and links, and B_v is the viscous friction coefficient. T_D is the disturbance load including Coulomb friction, off-diagonal terms of inertial force, centrifugal, Coriolis, and gravity forces.

To simplify, equation (13) can be rewritten in the form

$$\ddot{\theta} + A\dot{\theta} = U \tag{14}$$

where

$$A = \frac{1}{M_e} \left(B_v + \frac{K_e K_t}{R_a} \right) = \frac{B}{M_e} \tag{15}$$

$$U = \frac{1}{M_e} \left(V_t \frac{K_t}{R_a} - T_D \right) \tag{16}$$

For a given step voltage, all the terms in the equations (15) and (16) are constants. The torque constant, K_t , and armature resistance, R_a , are either known from the manufacturers specification or can be measured, but the combined moment of inertia, M_e , damping, B , and disturbance, T_D , are unknown. Note that since stiction friction force is only experienced at Starting from stand-still condition, it is not included in the dynamic model.

Equation (14), which is nonhomogenous, can be solved by the general method. The corresponding solution of differential equation (14) is

$$\theta(t) = E_1 + E_2 e^{-At} + (U/A)t \tag{17}$$

where E_1 and E_2 are constants.

The initial conditions of equation (17) are

$$\theta(0) = 0, \dot{\theta}(0) = 0$$

By substituting the initial conditions into this equation, the constants are given by

$$E_1 = -U/A^2, E_2 = U/A^2$$

substitution into equation (17) yields

$$\theta(t) = \frac{U}{A^2} (e^{-At} + At - 1) \tag{18}$$

Substituting Taylor series for the exponent, e^{-At} , into equation (18) gives

$$\theta(t) = U \left(\frac{t^2}{2!} - \frac{At^3}{3!} + \frac{A^2 t^4}{4!} - \frac{A^3 t^5}{5!} + \frac{A^4 t^6}{6!} \dots \right) \tag{19}$$

Constants A and U are obtained by Least Square method applied to equation (19) using many data, $\theta(t)$ and t , for a given step input voltage. The combined moment of inertia, M_e , and damping, B , relative to the viscous friction and the back emf are determined by equations (15) and (16). Coulomb friction can be obtained using a data set from a different input voltage. From equations (15), (16) and (19), we note the following properties: 1) From measuring a step input voltage and output (only angular position) as a function of time, A and U can be obtained. A and U are constants for a given step input voltage, consisting of an input voltage the combined term of viscous friction and back emf, Coulomb friction, armature winding resistance and the combined inertial moment of the motor and the robot links. 2) The combined moment of inertia, M_e , the combined term of viscous friction and back emf, B , and the Coulomb friction, T_b , are directly determined from A and U . It is not necessary to separate the viscous friction from the combined term because the viscous friction and the back emf both act as damping term.

3. Dynamic Properties of a Manipulator

In the absence of friction or other disturbance, the dynamics of an n -link rigid manipulator can be written as

$$M[\theta]\ddot{\theta} + CE[\theta][\dot{\theta}^2] + CO[\theta][\dot{\theta}\dot{\theta}] + G[\theta] = \tau \quad (20)$$

where:

$\tau = [\tau_1 \tau_2 \cdots \tau_n]^T$ $n \times 1$ vector of the joint torques,

$M(\theta)$ $n \times n$ definite inertia matrix,

$CE[\theta]$ $n \times n$ centrifugal coefficients matrix,

$CO[\theta]$ $n \times n(n-1)/2$ Coriolis coefficients matrix,

$G[\theta]$ $n \times 1$ vector of gravity force,

$\dot{\theta}$ $[\dot{\theta}_1 \dot{\theta}_2 \cdots \dot{\theta}_n]^T$

$\dot{\theta}\dot{\theta}$ $[\dot{\theta}_1 \dot{\theta}_2 \dot{\theta}_1 \dot{\theta}_3 \cdots \dot{\theta}_{n-1} \dot{\theta}_n]^T$

$\dot{\theta}^2$ $[\dot{\theta}_1^2 \dot{\theta}_2^2 \cdots \dot{\theta}_n^2]^T$

In this form of the dynamic equations, the complexity of the computation is seen to be the form of computing various parameters which are a func-

tion of inertial parameters and the manipulator position, θ . The closed form dynamic model of a six degrees of freedom robot is in general very complex, but the closed form dynamic equation can be obtained using a symbolic computation program [11]. To investigate the forms of each term in the dynamic equation, the closed form dynamic equations of the University of Minnesota Direct Drive Manipulator were derived in [10].

The internal properties of the dynamic equations are as follows: Centrifugal force at joint depends on the square of the other joint velocities because diagonal terms in the centrifugal coefficient matrix are zero. Coriolis force is proportional to the product of two different joint velocities. The gravity term depends on only θ . Since the inertial parameters of all the links are constant, the inertial parameters can be directly applied to the dynamic equations for a control algorithm.

For parameter identification, when only one joint moves, the Coriolis and the centrifugal terms disappear in the dynamic equation. The dynamic equation can then be written by

$$\tau = M[\theta]\ddot{\theta} + G[\theta] \quad (21)$$

If the robot is statically balanced, only inertial term appears in the equation.

$$\tau = M[\theta]\ddot{\theta} \quad (22)$$

To identify the dynamic parameters, only the diagonal terms in the inertial matrix are needed. An example of these inertial terms of the University of Minnesota Direct Drive Manipulator is given in the Appendix A.

4. Identification Procedure for an N Degree of Freedom Robot

The identification procedure for a manipulator is presented in this Section. To simplify the derivation of the dynamic equation for the N links of the manipulator, the parameter identification problem is started from link N (the tip) and proceeds sequentially to link 0 (the base). The inertial parameters of each link are individually identified. The

inertial parameters identified for link i become known parameters in the dynamic equation of the link $i-1$. The parameter identification procedure is as follows:

- 1) All the joints are locked at their desired positions except the joint to be tested.
- 2) Apply a step input voltage to the robot and measure the position of the joint as a function of time. To estimate the Coulomb friction, the measurements of the position must be conducted for two different step inputs because there are three unknowns in two equations(The position of a joint can be measured from the encoder or resolver mounted at the shaft of the joint).
- 3) Calculate A and U using the experimental data (time and position). Determine the combined inertia, M_e , and the combined damping term, B using equations (15) and (17).
- 4) Compare the combined inertia M_e obtained experimentally with the inertial term from the closed from dynamic equation.(Note that only the inertial term in the dynamic equation is used for the parameter identification, because there are no effects of centrifugal and Coriolis force by locking all the joints except the joint tested).

5. Experimental results

Hardware

Experiments for identifying dynamic parameters were performed on the University of Minnesota Direct Drive Robot(as shown in Fig.2), which has three degrees of freedom. The control hardware system for the robot is shown in Fig.3).

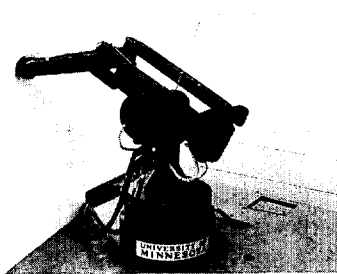

Fig. 2 The University of Minnesota Direct Drive Robot

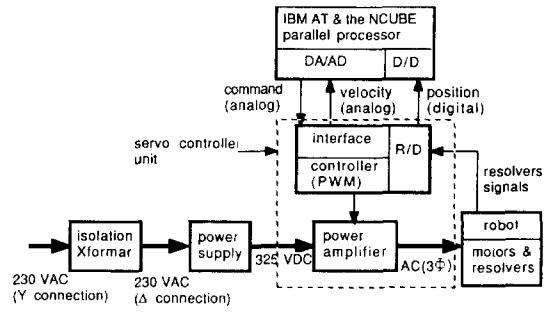

Fig. 3 The Control Hardware for Minnesota Robot

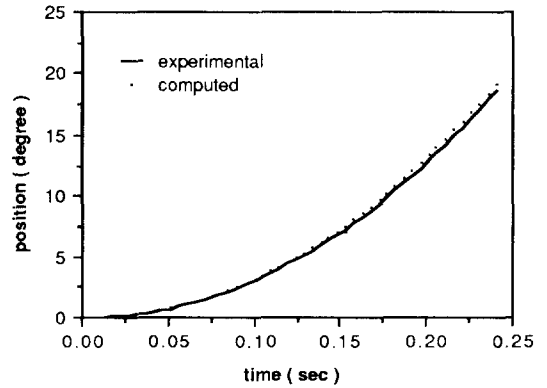

Fig. 4 Position vs. time for a step input for motor 2

An IBM AT microcomputer, hosting a 4-node parallel processor, is used as the main controller of this robot. Each node is an independent 32-bit processor with local memory and communication links to the other nodes in the system. A high speed AD/DA converter is used to read the velocity signals and to send analog command signals to the servo controller unit. A parallel IO board (D/D converter) between the servo controller unit and the computer allows for reading the R/D (Resolver to Digital) converter.

The servo controller unit produces three phase, Pulse Width Modulated(PWM), sinusoidal currents for the power amplifier. The servo controller unit contains an interpolator, R/D converter and a communication interface for the computer. The servo controller unit can be operated in either a closed loop velocity or current (torque)control

Table 1 Inertial parameters for the University of Minnesota Direct Drive Manipulator

	Parameters	identified value	Computed value
Inertial (kg-m ²)	I_{z1}	0.19719	0.1752
	I_{x2}	0.02592	0.04125
	$m_2\bar{X}_2^2 + I_{e2} + I_{y2}$	1.68135	1.06955
	$m_2\bar{X}_2^2 + I_{e2} + I_{z2}$	1.78135	1.16955
	$I_{e1} + I_{e5}$	0.28922	0.298045
	$I_{e1} + I_{e6}$	0.27759	0.296158
	I_{e3}	0.20	0.2498
	I_{e4}	0.14543	0.1319
Damping in joint (Nm-sec/rad)	motor 1	0.036	—
	motor 2	0.078	—
	motor 3	0.27	—
Coulomb in joint (Nm)	motor 1	2.52	—
	motor 2	1.0	—
	motor 3	0.02	—

mode(current control is used). A PWM power amplifier, which provides up to 47 amperes of drive current from a 325 volt power supply, is used to power the motors. The main DC bus power is derived by full-wave rectifying the three phase 230VAC incoming power. This yields a DC bus voltage of 325VDC.

This robot employs neodymium (NdFeB) magnet AC brushless synchronous motors. Due to the high magnetic field strength (maximum energy products: 35 MGOe) of the rare earth NdFeB magnets, the motors have high torque to weight ratios. Pancake type resolvers are used as position and velocity sensors. The peak torque of motor 1 is 118Nm, while the peak torques of motors 2 and 3 are 78 and 58 Nm respectively.

Identification Results

A step command signal to a joint results in a constant torque output. Joint position was measured using a resolver. The position of the joint was sampled at 2.4 ms intervals. Each data point consists of the command voltage, position and time. A step input was applied to one motor(actuating one joint). The other joints were locked at desired positions using a fixed position control algorithm. Real time and joint position informations were stored in the direct memory of the computer while the link was tested. A file storing the time and the position data was created after moving the link. Inertial parameters were

obtained using the identification procedure outlined in previous Section. Fig. 4 shows the position vs. time for a given step command voltage. The computed trajectories from the identified dynamic parameters agree well with the experimental trajectory curves. The results of the identification for the robot dynamic parameters are summarized in Table. 1 Because the first link has only one degree of freedom (about the Z-axis), only the I_{z1} term in the dynamic equation appears. Some parameters in the Table 1 can only be identified in linear combinations. The 6 inertial parameters of joint 3 must be lumped together because joint 3 is operated by a four bar mechanism.

6. Feedforward Control Experiments

To verify the accuracy of the experimental dynamic parameters, feedforward control without feedback compensation is applied to the robot. The integrated dynamic model and the identified parameters are used for the control law. The dynamic model does not include the gravity terms because the University of Minnesota Manipulator is statically balanced. The reference trajectory in the experiment is generated by a cubic polynomial. The experimental trajectory is compared with the desired trajectory. The robot control program, written in C language, yields a 250Hz sampling frequency. Each joint was commanded to move 30

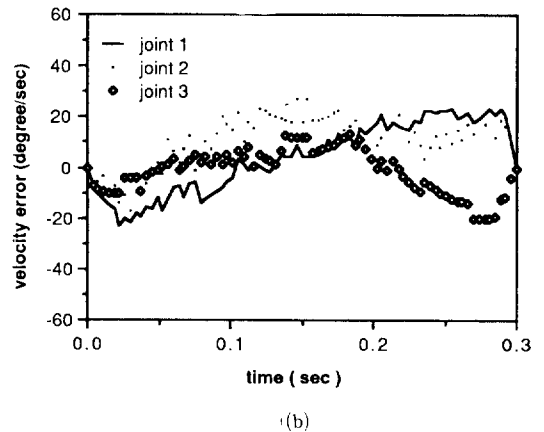
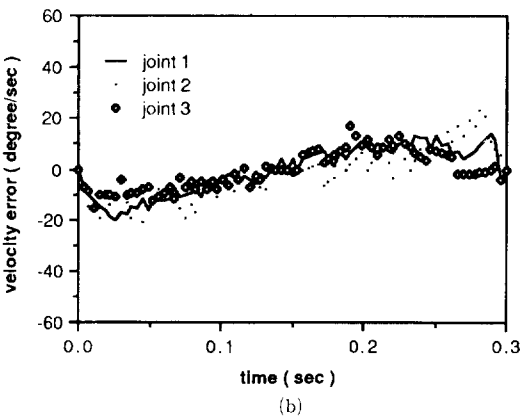
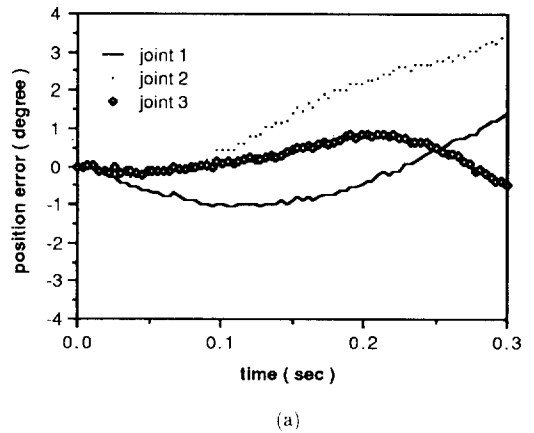
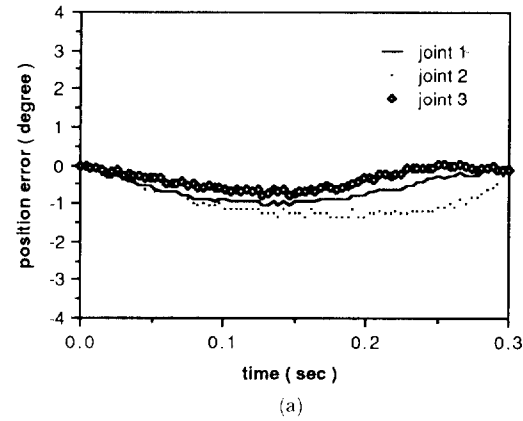

Fig. 5 Trajectory and velocity error curves in each joint with single joint motion. (a) position error, (b) velocity error

Fig. 6 Trajectory and velocity error curves in each joint with full robot motion. (a) position error, (b) velocity error.

degrees in 0.3 seconds from a predetermined origin. The maximum velocity and acceleration for each joint are 150 degree/sec and 2000 degree/sec², respectively.

The trajectory and velocity errors for each joint are depicted in Fig. 5 and 6. Fig. 5 shows the trajectory and velocity errors when each joint was commanded to move 30 degrees in 0.3 seconds from a predetermined origin. The maximum tracking errors are -1.06° , -1.35° , and 0.78° for joint 1, 2 and 3, respectively. Fig. 6 shows the trajectory and velocity errors when all joints were commanded to simultaneously move 30 degrees in 0.3 seconds from a predetermined origin. The peak trajectory errors are 1.38° , 3.4° and 0.78°

for joint 1, 2 and 3 respectively. The results show that the trajectory and velocity errors are increased when all joints were simultaneously moved, because the complex nonlinear dynamic characteristics and unmodeled dynamics exist in the system. Since the modeled system is never the same as the actual system, a closed loop feedback control method is required to compensate for small error.

7. Summary

The identification of the inertial parameters was obtained by an integrated robot dynamic system identification method. Damping friction

and Coulomb friction were also identified. Most inertial parameters were directly identified by comparing the inertial terms in the closed form dynamic equation. Some dynamic parameters were identified in linear combinations, as in other methods[5, 6]. The accuracy of the parameters identified was experimentally proven by examining the dynamic tracking accuracy along a specified trajectory. The advantages of this method may be summarized as follows:

1) Dynamic parameters such as inertial parameters, viscous friction and Coulomb friction are identified.

2) This method only needs to measure the joint position as a function of time for a given step input. A torque measuring device is not required to identify the parameters.

3) The diagonal terms in the inertial matrix of a dynamic equation are used.

4) This method can be extended to estimated a load at the end point of a robot.

Appendix A

The closed dynamic equations have been derived for the purpose of controller design. The inertia term is described as in (A-1)

$$M[\theta] = \begin{bmatrix} M_{11} & M_{12} & M_{13} \\ M_{12} & M_{22} & O \\ M_{13} & O & M_{33} \end{bmatrix} \quad (\text{A-1})$$

where each element is given by

$$M_{11} = I_{z1} + C_2^2[I_{e1} + I_{e6} + I_{e2} + 2C_3I_{e3} + I_{y2} + m_2\bar{X}_2^2] + S_2^2[S_3^2[I_{e1} + I_{e5}] + C_3^2I_{e4} + I_{x2}] \quad (\text{A-2})$$

$$M_{12} = S_2S_3[I_{e3} + C_3[I_{e1} + I_{e5} - I_{e4}]] \quad (\text{A-3})$$

$$M_{13} = C_2[I_{e1} + I_{e6} + C_3I_{e3}] \quad (\text{A-4})$$

$$M_{22} = I_{22} + m_2\bar{X}_2^2 + C_3^2[I_{e1} + I_{e5}] + S_3^2I_{e4} + I_{e2} + 2C_3I_{e3} \quad (\text{A-5})$$

$$M_{33} = I_{e1} + I_{e6} \quad (\text{A-6})$$

where:

$$I_{e1} = m_3\bar{X}_3^2 + m_4L_5^2 + m_5\bar{X}_5^2$$

$$I_{e2} = m_3[L_2 - g]^2 + m_4[\bar{X}_4 - g]^2 + m_5g^2$$

$$I_{e3} = m_3\bar{X}_3[L_2 - g] - m_4[\bar{X}_4 - g]L_5 + m_5\bar{X}_5g$$

$$I_{e4} = I_{x3} + I_{x4} + I_{x5}$$

$$I_{e5} = I_{y3} + I_{y4} + I_{y5}$$

$$I_{e6} = I_{z3} + I_{z4} + I_{z5}$$

The definitions of link parameter used above have been details in[10]

참 고 문 헌

- [1] Luh, J. Y. S., Walker, M. w. and Paul, R. P., "On Line Computational Scheme for Mechanical Manipulators". Journal of Dynamic Systems, Measurement, and Control 102(2) : 69-76, June, 1980.
- [2] Luch, J.Y.S., Walker, M. W. and Paul, R. P. "Resolved-Acceleration Control of Mechanical Manipulators", IEEE Transactions on Automatic Control 25(3), pp.468 ~ 474: June, 1980
- [3] Paul, R.P., "robot Manipulator : Mathematics, Programming and Control.", MIT press, Cambridge, 1981 MA
- [4] Coiffet, P., "Robot technology. Volume 2: Introduction with the Environment". Prentice-Hall, 1983 NJ
- [5] Atkeson, C.G., An, C.H. and Hollerbach, J. M., "Estimation of Inertial Parameters of Manipulator Loads and Links", International Journal of Robotics Research, vol. 5, No. 3, Fall, pp.101~119. 1986
- [6] Khosla, P.K. and Kanad, T., "Parameter Identification of Robot Dynamics", Proceedings of 24th Conference on Decision and Control, Ft Lauderdale, Fl. Dec. pp.1754 ~1760. 1985
- [7] Kazerooni, H. and Kim, S., "Statically-Balanced Direct Drive Robot for Compliance Control Analysis", ASME Winter Annual Meeting, in "Modeling and Control of Robotic Manipulators and Manufacturing Process", DSC-Volume 6, pp.193~201, Boston, MA., December 1987.
- [8] Kazerooni, H. and Kim, S., "A New Architecture for Direct Drive Robots", IEEE International conference on Robotics and Automation, Volume 1, pp.442~445, Philadelphia, PA, April 1988.
- [9] Kazerooni, H. and Kim, S., "Design and Control of a Statically Balanced Direct Drive Manipulator", USA-JAPAN Symposium on

Flexible Automation, Vol. 1, pp. 449~454,
Minneapolis, Minnesota, July 1988.

- [10] Kim, S., "Design, Analysis, and Control of a
Statically Balanced Direct Manipulator",

The University of Minnesota Ph. D. Disserta-
tion. 1988

- [11] Mathlab group, "MACSYMA Reference Ma-
nual, version 10", Cambridge, Mass. 1983