

論 文

集中定數型 3dB 90° Hybrid 廣帶域 設計에 關한 研究

正會員 金 東 一* 正會員 鄭 世 謨** 正會員 金 是 和***

Broad-Band Design of Lumped-Element 3dB Quadrature Hybrid

Dong Il KIM*, Se Mo CHUNG** and Si Hwa KIM,*** Regular Members

요 약 신호의 90° 위상차 분배/합성이 가능한 Quadrature Hybrid는 Image Rejection Mixer 등에 널리 쓰이고 있으며, 특히 VHF 대 위성통신을 행할 경우에는 집중정수형으로 제작하는 것이 대단히 유리하다. 이 경우 자기결합을 갖게 되면 제작이 곤란하므로 자기결합을 갖지 않는 형식으로 광대역 특성을 갖는 소자를 설계하는 것은 대단히 중요하다. 본 연구에서는 자기결합을 갖지 않는 90° Hybrid의 기본회로를 제안하고, 이 기본회로를 Phase Shifter를 이용하여 Cascade로 연결하고 최적화함으로써 광대역화하는데 성공하였다. 여기서 설계한 Hybrid는 약 54%의 대역폭을 가지며, Branch-Guide Type 방향성 결합기에 비하여 훨씬 더 우수한 특성을 가짐을 입증하였다. 또한, 실험에 의하여 제안한 설계법의 타당성을 확인하였다.

ABSTRACT A broad-band design method of a lumped-element 3 dB quadrature hybrid without magnetic coupling is proposed and discussed, where techniques of cascading fundamental hybrids via second-order delay equalizers and adding matching sections are adopted. It is shown that the designed broad-band lumped-element 3dB quadrature hybrid can be easily constructed and its bandwidth reaches up to 54%. Furthermore, the experiments have been carried out, the results of which agree with the theoretical ones, and hence, the validity of the broad-band design method proposed here was confirmed.

1. Introduction

A lumped-element quadrature hybrid which has the capability of dividing the input signal equally into two ports is widely used for SSB

modulator, image rejection mixer, variable phase shifter, or small sized VHF transmission circuits for satellites. In VHF range, it is preferable to use a lumped-element hybrid since it usually is very large in size.

There are two types of conventional lumped-element 90° hybrids, one of which is with magnetic couplings between coils and the other is without magnetic couplings. The former usually uses twisted wires for tight magnetic couplings between coils. The concept of using twisted wires wrapped upon ferrite toroids to form compact, asym-

* 韓國海洋大學電子通信工學科

Dept. of Electronics and communication Engineering, Korea Maritime University Busan, 606 Korea.

** , *** 韓國海洋大學, 航海學科

Dept. of Nautical Science, Busan, 606, Korea

論文番號 : 85-38 (接受 1985. 10. 18)

metric, 180°-hybrids was firstly introduced by Ruthroff^[1]. It has also been found that twisted-wire structures can be made to function as symmetric 3dB quadrature hybrids^{[2],[3]} as shown in Fig. 1. This hybrid operates at

$$Z_0 = \sqrt{L/C} \quad (1)$$

and the operating frequency ω_0 is given by

$$\omega_0 = \sqrt{LC} \quad (2)$$

Such hybrid is a very narrow-band network, since equal power division occurs at one frequen-



그림 1 강한 磁氣結合을 가지는 集中定數型 90° 하이브리드
Lumped-Element Quadrature Hybrid with Tight Magnetic Coupling.



그림 2 강한 磁氣結合을 가지는 2단 90° 하이브리드에 대한 應答特性的 計算值
Computer-Generated Characteristics of Two-Stage Quadrature Hybrid with Tight Magnetic Coupling.

cy. It has been described in^[3] that a cascade of two symmetric 3dB 90° hybrids, consisting chiefly of a bifilar pair of twisted wires, can achieve an octave bandwidth with a 0.7 dB coupling error α as shown in Fig. 2. Here, ports 3 and 4 of the first hybrid are connected, respectively, to the ports 1' and 2' of the second identical hybrid via sections Z_0 coaxial cable each having an electrical length θ at ω_0 . A disadvantage of this cascade technique is that the coaxial connecting cables become prohibitively long as the hybrid operating frequency is lowered. Furthermore, the lumped-element quadrature hybrids with magnetic couplings between coils have defect in difficulty of construction since tight coupling between coils are needed.

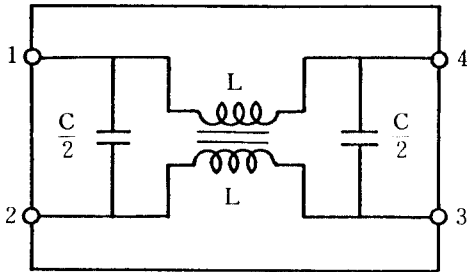
On the other hand, a lumped-element quadrature hybrid equivalent to the branch-guide coupler in a distributed-element the quarter-wave sections of which are substituted into lumped-element 90° phase shifters as shown in Fig. 3(a) has been proposed in^[4]. This hybrid has no magnetic couplings between coils, and so, it can be easily fabricated. But, its bandwidth is also very narrow as shown in Fig. 3(b) so that it extends to 8% only.

To resolve these problems, we thus, broaden the band-width of the hybrid shown in Fig. 3(a),

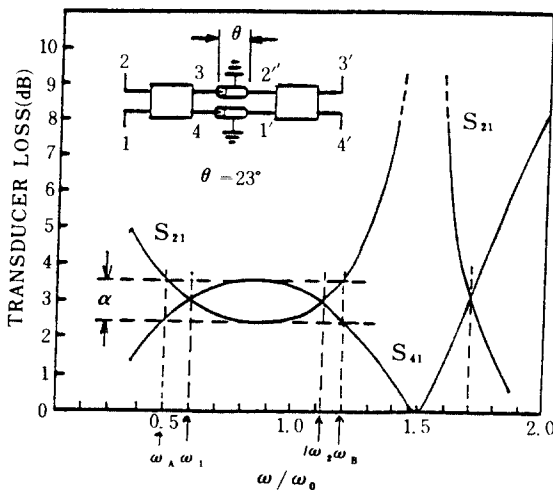

그림 3 (a) 磁氣結合을 갖지 않는 基本的인 集中定數型 90° 하이브리드
Fundamental Lumped-Element 90° Hybrid without Magnetic Couplings ($L_1 = Z_0 / \sqrt{2} \omega_0$, $L_2 = Z_0 / \omega_0$, $C = (1 + \sqrt{2}) / \omega_0 Z_0$)



그림 3 (b) 基本的인 90° 하이브리드의 周波數 特性
Frequency Characteristics of the Fundamental
Quadrature Hybrid shown in Fig. 3(a).

which is referred to as the fundamental hybrid, by optimization using CAD after cascading the two sections via delay equalizers (phase shifters) and adding the matching sections to each port. Furthermore, the comparison with the multi-stage branch-guide type hybrid which is simply cascaded by the fundamental type hybrid^{[5],[6]} which is simply cascaded by the fundamental hybrid is made in frequency characteristic and bandwidth.

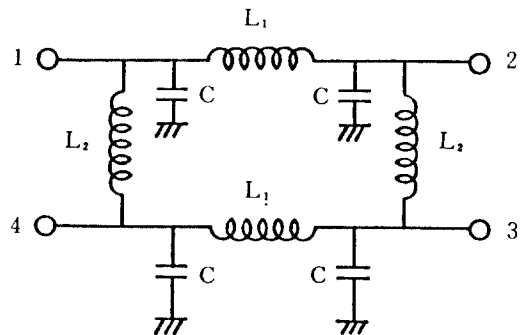
Throughout this paper, we take the tolerance limits of ± 0.43 dB for coupling deviations (Appendix A1) and of 20 dB for the maximum reflection and isolation.

2. Broadbanding the 3dB Quadrature Hybrid without Magnetic Couplings

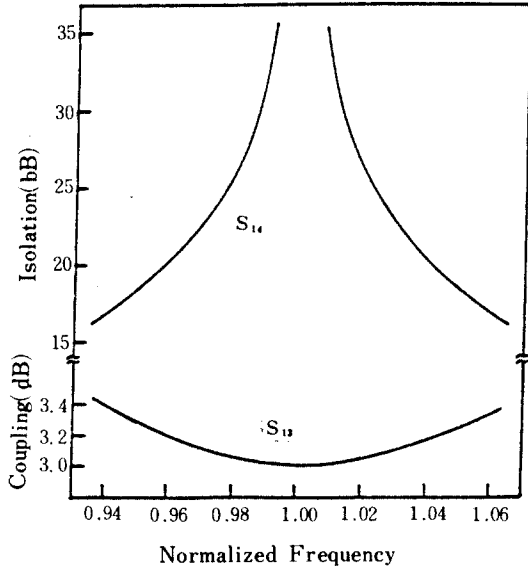
In general, the scattering matrix [S] of the four-port symmetrical and reciprocal hybrid directional coupler is given by

$$[S] = \begin{pmatrix} S_{11} & S_{12} & S_{13} & S_{14} \\ S_{12} & S_{11} & S_{14} & S_{13} \\ S_{13} & S_{14} & S_{11} & S_{12} \\ S_{14} & S_{13} & S_{12} & S_{11} \end{pmatrix} \quad (3)$$

For an ideal 3dB quadrature hybrid, the following scattering parameters are required in broad frequency band;

$$\begin{aligned} S_{11} &= 0, \quad S_{12} = 1/\sqrt{2}, \\ S_{13} &= \pm j/\sqrt{2}, \quad S_{14} = 0 \\ \text{or, } S_{11} &= 0, \quad S_{12} = 1/\sqrt{2}, \\ S_{13} &= 0, \quad S_{14} = \pm j/\sqrt{2} \end{aligned} \quad (4)$$

However, the above scattering parameters over a broad frequency band cannot be realized generally and are valid only at certain point frequencies.

Thus, it is generally required in actual characteristics of a hybrid circuit, a power divider, or a circulator that the couplings, matching, and isolation are to be within certain tolerance limits over a broad frequency band even though the circuit may not be perfectly matched and isolated at the center frequency. Considering the required characteristics of the 3dB quadrature hybrid including broad-banding, we define an evaluation function F as follows;

$$F = \sum_{j=1}^N \{ a_{11} |S_{11}|^2 + a_{12} |S_{13}|^2 + a_{13} (|S_{12}| - \frac{1}{\sqrt{2}})^2 + a_{14} (|S_{14}| - \frac{1}{\sqrt{2}})^2 \} f_j \quad (5)$$

where N is the number of sampling points, f_j 's are the sampled frequencies, and a_{ji} 's are the weighting coefficients for broadbanding.

The values of the circuit constants can be obtained numerically so as to minimize F and broaden the bandwidth widely as much as possible where the responses are within the range of the prescribed tolerance limits. Powell's minimizing method^[7] was used for this optimization.

tion. This optimization method was proposed in [8], [9], and [10], by which excellent design of directional couplers, power dividers, and five-port circuits were obtained. The circuit constants obtained by the above method are not unique. They depend on the choice of a_{ji} 's and f_j 's. Thus, the weighting coefficients a_{ji} 's and the sampling frequencies f_j 's have great significance in computations of the optimum circuit constants. As for the optimum circuit constants, we select the values of parameters which make the bandwidth widest within the extent of the tolerance limits for all responses by adjusting a_{ji} 's and f_j 's.

In practice, we performed optimization for the hybrids which are simply cascaded in multi-stage with the fundamental hybrid, and for the hybrid which constructed by cascading two fundamental hybrids via delay equalizers and adding matching sections at all ports. The former is termed as the branch guide type 3dB quadrature hybrid, and the latter is termed as the broadband 3dB quadrature hybrid since this is much broadened in bandwidth in comparison with the branch-guide type one.

3. Numerical Results

We took 5 or 7 sampling points of frequencies at appropriate intervals and proper weighting coefficients, and computed the optimum circuit constants for the branch-guide type 3dB 90° hybrids and the broadband one by Powell's minimizing method, while the design center frequency is fixed at 140 MHz and the characteristic impedance Z_0 to the external line is 50Ω.

First, we performed optimization for the branch-guide type hybrids as shown in Fig. 2.4. Here the circuit is named n-stage branch-guide hybrid after the n of L_{a_n} . For a 90° directional coupler, the two-fold symmetry is needed in the

circuit shown in Fig. 4; i.e.,

$$\left. \begin{aligned} L_{ar} &= L_{a_{n-r+1}} \\ L_{br} &= L_{b_{n-r}} \\ C_r &= C_{n-r+1} \end{aligned} \right\} r = 1, 2, 3, \dots, n \quad (6)$$

For the n-stage branch-guide hybrids (n=2, 3, 4, 5, 6, and 7), we performed optimization by the method described in Section II after scattering parameters were calculated and substituted into eq.(5). Then, we calculated the frequency characteristics and the bandwidth for the circuits with the optimized circuit constants. Figure 2.5 shows the bandwidths for the optimized n-stage branch-guide hybrids when n takes 2 through 7. We can see from Fig. 5 that the higher n takes, the broader



그림 4 集中定數型 브랜지 가이드 90° 하이브리드.
Branch-Guide Type Lumped-Element 90° Hybrid.



그림 5 最適化된 n단 브랜지 가이드 하이브리드의 帶域幅
(⊗: 廣帶域90° 하이브리드의 帶域幅을 나타낸다)
Bandwidths of the Optimized n-Stage Branch-Guide Hybrids
(⊗ shows the bandwidth of the Broadband Lumped-Element 90° Hybrid)

the bandwidth becomes. However, it is scarcely effective to increase n when n is greater than 5, while the bandwidth of the optimized 5-stage branch-guide hybrid is about 40%. When n becomes greater than 5, the bandwidth for the return loss and isolation becomes broader but the couplings are scarcely improved in bandwidth as shown in Fig. 6.

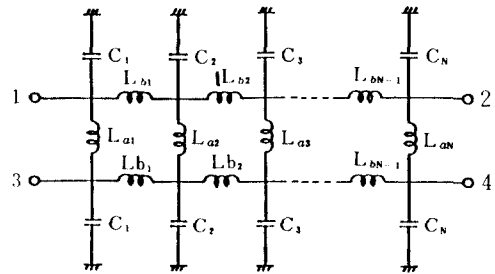

그림 6 (a) 5단 브랜치가이드 하이브리드의 應答特性
Response Curves for 5-Branch-Guide Coupler
($C_1=33.7$, $C_2=159.7$, $C_3=167.8$ pF, $L_{a1}=\infty$,
 $L_{a2}=0.046$, $L_{a3}=0.00972$, $L_{b1}=0.0313$,
 $L_{b2}=0.01102$ μ H).

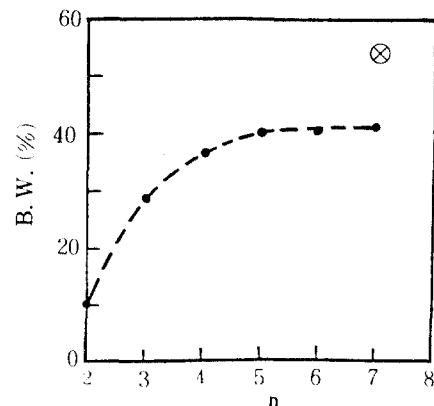
Next, we consider the lumped-element 3dB 90° hybrid which is constructed by cascading two fundamental hybrids via delay equalizer and adding matching sections, since it is recognized from the above investigation that there exist limits of bandwidth for the multi-stage branch-guides type hybrid when n is simply increased. Therefore, we performed optimization for the



그림 6 (b) 7단 브랜치가이드 하이브리드의 應答特性
Response Curves for 7-Branch-Guide Coupler
($C_1=19.88$, $C_2=55.77$, $C_3=107.5$, $C_4=145.24$ pF,
 $L_{a1}=1.255$, $L_{a2}=0.3352$, $L_{a3}=0.07945$, $L_{a4}=\infty$,
 $L_{b1}=0.02102$, $L_{b2}=0.04993$, $L_{b3}=0.0357$, $L_{b4}=0.0219$ μ H).

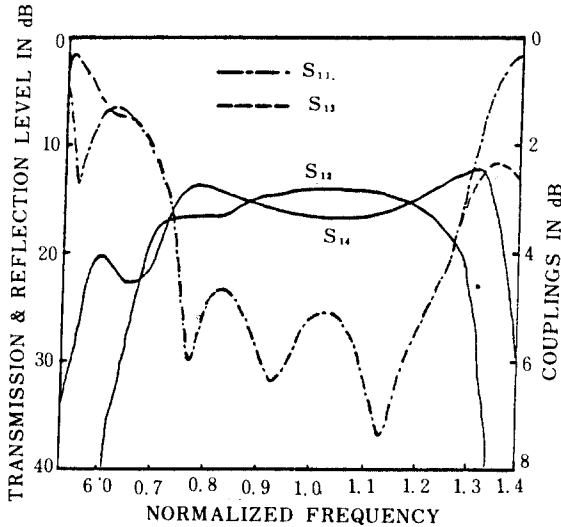

그림 7 集中定數型 廣帶域 90° 하이브리드
Broad-Band Lumped-Element Quadrature Hybrid.

circuit shown in Fig. 7, where the delay equalizers [11] inserted are of second order as described in Appendix A2. In the same manner as the above, the optimized values of the circuit constants and the frequency characteristics with the optimized circuit constants are shown in Fig. 8.

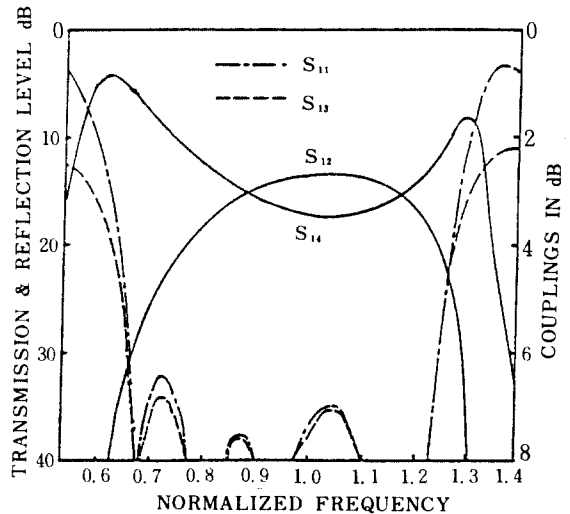

그림 8 集中定數型 廣帶域 90° 하이브리드의 周波數特性
 Frequency Characteristics for the Broadband Lumped-Element 90° Hybrid ($C_1=78.67$, $C_2=67.80$, $C_{s1}=89.08$, $C_{s2}=44.54$, $C_M=25.93 \mu F$, $L_{s1}=0.02693$, $L_{a1}=0.1139$, $L_{a2}=0.04866$, $L_s=0.05667$, $L'_s=0.0$, $L_M=0.04121 \mu H$).

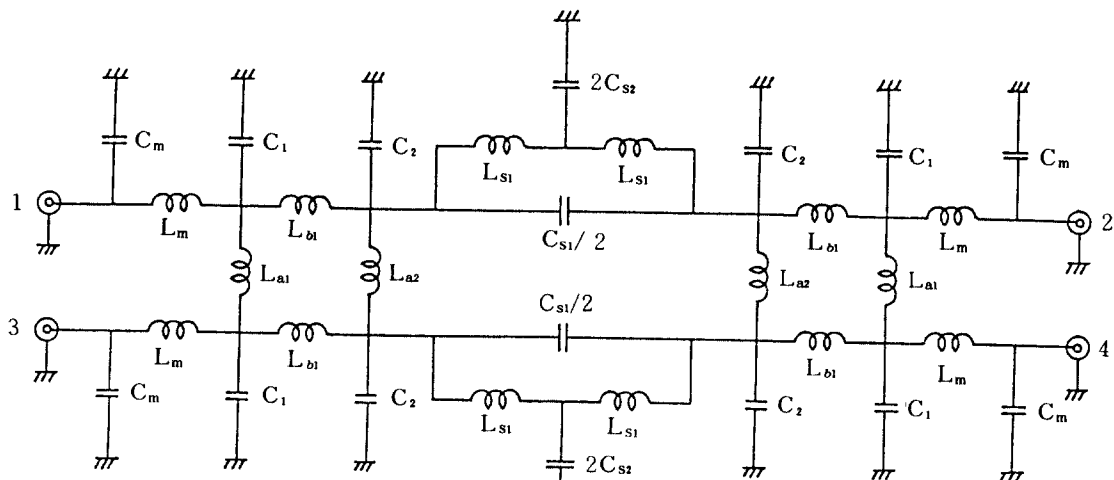
The bandwidth of the optimized hybrid in this form extends to 54%, while the bandwidth of the 7-stage branch-guide hybrid, the number of which is nearly equal to that of the broadband 3dB 90° hybrid, does not exceed 42%. This is the reason why the optimized 3dB 90° hybrid of this form is referred to as the broadband lumped-element 3dB quadrature hybrid. Therefore, it is extremely broadened in bandwidth in comparison with the simply cascaded branch-guide hybrids. Thus, it was clearly proven that cascading two fundamental hybrids via delay equalizer and adding matching section to each port is very effective for broadbanding.

Furthermore, the optimum value of L_s' in the delay equalizer shown in Fig. A4 is found

to be zero since L_s' always converges to zero in the optimization. In consequence, the delay equalizer adopted in the broadband 3dB quadrature hybrid results in the form as was shown in Fig. 7.

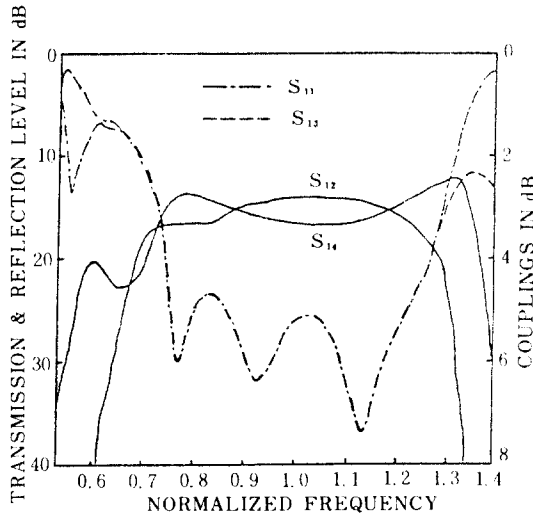
4. Experimental Results

To confirm that the design method of the broadband lumped-element 3dB 90° hybrid is valid, we have constructed the circuit at the center frequency of 35 MHz and tested its frequency characteristics. In experiments, all the coils were made of polyurethane wire of 0.4 mm in diameter, and all the capacitors were ceramic condensers made by Murata Electronic Co., Ltd in Japan. In Fig. 9 photographs of measuring setup



그림 9 (a) 測定裝置
 Photograph of Measuring Setup.



그림 9 (b) 製作한 廣帶域 90° 하이브리드
 The Constructed Broadband 3dB 90° Hybrid.

and the constructed broadband 3dB 90° hybrid are shown.

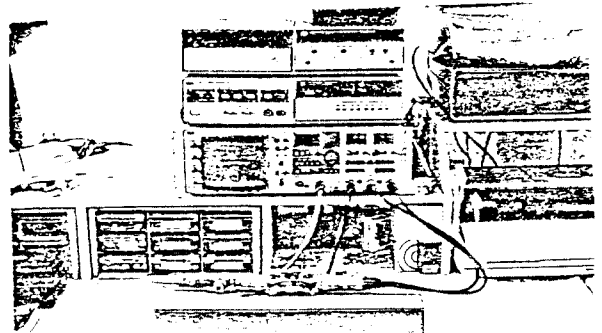
Figure 10 shows the measured frequency characteristics for the fabricated circuit including the optimized circuit constants, while the theoretical frequency responses were shown in Fig. 8. Here we can see that the measured frequency characteristics for the couplings, reflection, and isolation agree reasonably with the theoretical ones in tendency. However, the insertion loss is about 0.7dB, and the reflection and isolation characteristics are worse than the theoretical ones. In our experience, it is expected that the performance of the broadband lumped-element 3dB quadrature hybrid would be improved by using the condensers and coils with high Q and constructing elaborately.

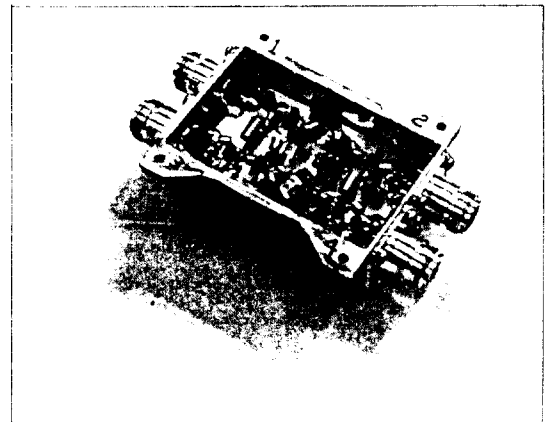

그림 10 廣帶域 90° 하이브리드의 周波數應答特性 (實測值, 中心周波數 : 35MHz)
 Measured Frequency Characteristics for the Broadband Lumped-Element 90° Hybrid (Center Frequency; 35MHz).

5. Conclusion

A design method of the broadband lumped-element 3dB quadrature hybrid without magnetic couplings between coils by CAD was demonstrated, where techniques of cascading fundamental hybrids via second-order delay equalizers and

adding matching sections were used. Thus, the proposed broad-band lumped-element 3dB quadrature hybrid can be easily constructed since tight magnetic couplings between coils are not needed, and its bandwidth reaches up to 54%. Furthermore, the broadband lumped-element 3dB 90° hybrid is compared with the n-stage branch-guide type hybrids in terms of the frequency characteristics and bandwidth. It was proven that the former has better characteristics than the latter.

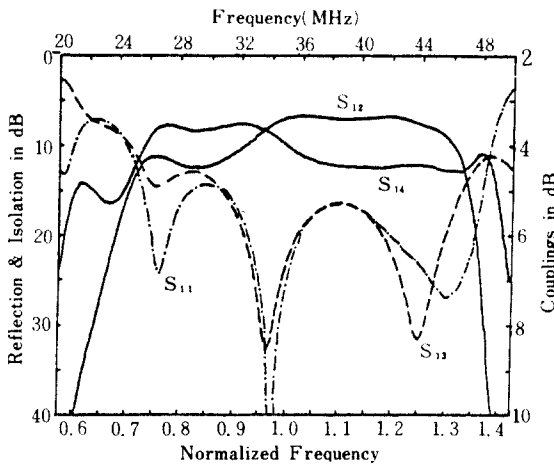
The experiment for the fabricated broadband lumped-element 3dB 90° hybrid was carried out, the results of which agree with the theoretical ones as a tendency, and, hence, the broadband design method proposed was verified. To improve, moreover, the insertion loss, return loss, and isolation, it is believed to be required to use the condensers and the coils with high Q.

ACKNOWLEDGEMENT

The authors wish to express their thanks to Professor Y. Naito of the Tokyo Institute of Technology, Japan, for valuable advice. This work was sponsored by the Korea Science & Engineering Foundation.

Appendix A1 Tolerance Limits for Couplings of 3dB Directional Couplers

Although tolerance limits for couplings, matching and isolation depend upon the degree of required performance, e.g., ± 0.5 dB for coupling deviations and 20dB for maximum reflection and isolation in the case of a balanced amplifier, the tolerance limits of ± 0.43 dB for the coupling deviations were taken, here, for the following reason.

Consider a lossless and matched directional coupler for simplicity as shown in Fig. A1, in ports 2 and 4 of which the loads with the reflection



그림 A1 整合型 無損失方向性結合器
Lossless and Matched Directional Coupler.

constant Γ are connected. Then, the following relations are satisfied;

$$|T_1|^2 + |T_2|^2 = 1 \quad (A1)$$

$$|R| = |\Gamma| \left| |T_1|^2 - |T_2|^2 \right| \quad (A2)$$

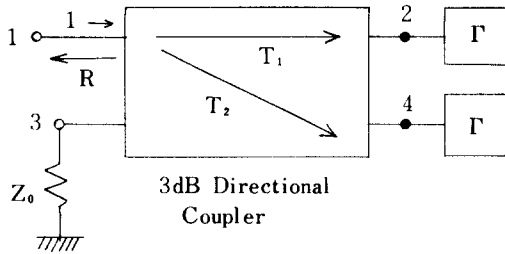
where R indicates the reflection coefficients at port 1 due to mismatches at ports 2 and 4, and T_1 and T_2 indicate the transmission coefficients. If we let $|\Gamma|$ be 1 as the worst case, then

$$|R| = \left| |T_1|^2 - |T_2|^2 \right| \quad (A3)$$

Substituting eq. (A1) into eq.(A3),

$$|R| = \left| 2|T_1|^2 - 1 \right| \quad (A4)$$

Here, if the tolerance limit of R is taken by -20dB, we can get the following tolerance limits of couplings from eqs. (A4) and (A1);

$$T_1 = -3.467\text{dB}, \quad T_2 = -2.596\text{ dB}$$

Therefore, the tolerance limits of couplings are given by $\pm 0.43\text{ dB}$ in this case.

Appendix A2 Delay Equalizer

The input impedance Z_{in} for the lattice network shown in Fig. A2 is given by

$$Z_{in} = \frac{(Z_1 + Z_2)R_0 + 2Z_1Z_2}{2R_0 + Z_1 + Z_2} \quad (A5)$$

It is satisfied that $Z_{in} = R_0$, if

$$Z_1Z_2 = R_0^2 \quad (A6)$$

Then, this lattice network becomes a phase shifter the phase shift of which depends upon X_1 and X_2 are pure reactive. In this case, the phase constant β and the phase delay θ are given by the following relations;

$$e^{\theta} = \frac{1 + jX_1/R_0}{1 - jX_1/R_0} \quad (A7)$$

$$\beta = 2 \tan^{-1} (X_1/R_0)$$

and the circuit like phase shifter or all-pass network is called the delay equalizer because it changes the phase only without insertion loss. The delay equalizers are classified into first- and second-order delay equalizers according to the order of Z_1 .



그림 A2 格子回路網
Lattice Network.

(1) First-Order Delay Equalizer

Figure A3 shows a first-order delay equalizer when Z_1 is composed of pure inductor. If, for this circuit, $Z_1Z_2 = L/C = R_0^2$, it becomes an all-pass network.

(2) Second-Order Delay Equalizer

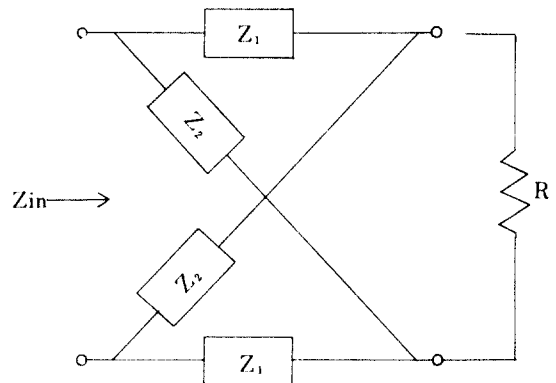
Since the center frequency of the first-order delay equalizer is zero, it is required to change the center frequency of zero for an arbitrary one. It can be realized by substituting L and C in Fig. A3 into a series resonating circuit and a



그림 A3 第1次 遲延等化器
First-Order Delay Equalizer.

parallel resonating circuit, respectively. Therefore, the second-order delay equalizer is represented by Fig. A4. If L_{S1} is equal to L_{S2} , L'_S becomes 0, i.e., does not be needed.

參 考 文 獻

(1) C. L. Ruthroff, "Some broad-band transformers," Proc. IRE, vol. 47, pp. 1337-1342, Aug. 1959.
 (2) K. Kurogawa, "Design Theory of balanced transistor amplifier," Bell Syst. Tech. J., vol. 44, No. 8, pp. 1675-1698, Oct. 1965.
 (3) R. E. Fisher, "Broad-Band Twisted-Wire Quadrature Hybrids," IEEE Trans. on MTT, vol. 21, No. 5, pp. 355-357, May 1973.

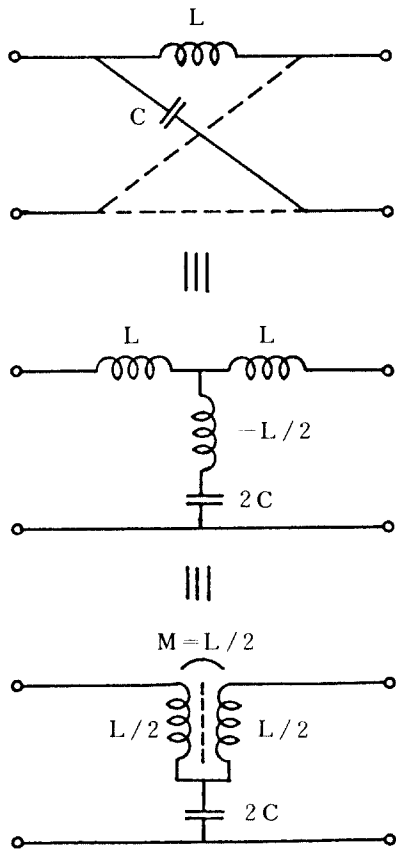

그림 A4 第2次 遲延等化器
Secon-Order Delay Equalizer.

(4) T. Kaneki and O. Akiyama, "Small-sized VHF Transmission Circuits for Satellites," NHK Tech. Rep. of Japan, vol. 21, No. 6, pp. 390-398, 1969.
 (5) J. Reed and J. Wheeler, "A Method of Analysis of Symmetrical Four-Port Networks," IRE Trans. on MTT, vol. 4, pp. 246-252, Oct. 1956.
 (6) R. Levy and L. F. Lind, "Symmetrical Branch-Guide Directional Couplers," IEEE Trans. on MTT, vol. 16, No. 2, pp. 80-89, Feb. 1968.

- (7) M. J. D. Powell, "A Method for Minimizing a Sum of Squares of Nonlinear Functions without Calculating Derivatives," Computer J., vol. 7, pp. 303-307, 1965.
- (8) D. I. Kim and Y. Naito, "Broad-band Design of Improved Hybrid-Ring 3dB Directional couplers," IEEE Trans. Microwave Theory and Tech., vol. MTT-30, pp. 2040-2046, Nov. 1982.
- (9) Dong Il Kim et al., "Optimum Design of the Power Dividers with Ferrite Toroids for CATV and/or MATV

Systems," IEEE Trans. Consumer Electron., vol. CE-28, No. 1, pp. 27-38, Feb. 1983.

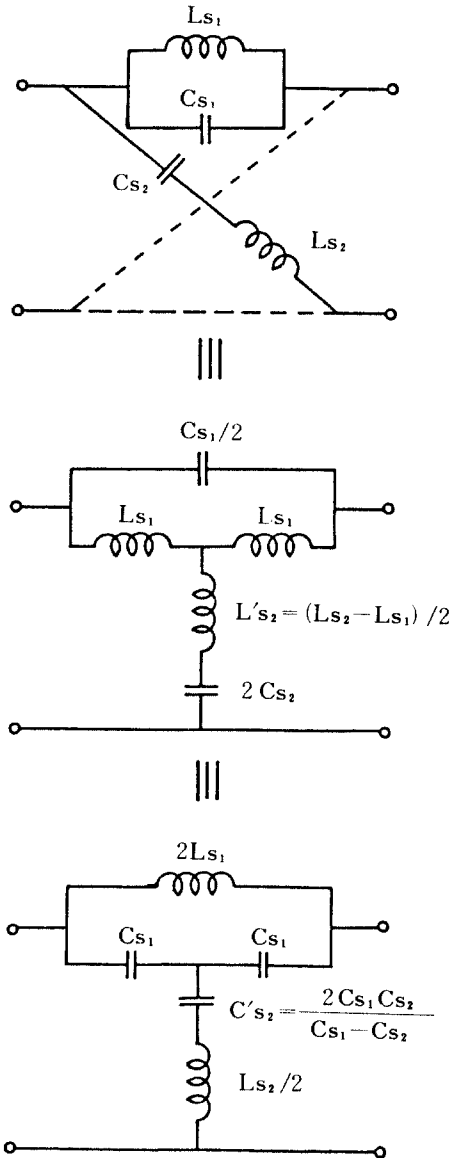
- (10) D. I. Kim, K. Araki, and Y. Naito, "Properties of the Symmetrical Five-Port Circuit and Its Broad-Band Design," IEEE Trans. Microwave Theory and Tech., vol. MTT-32, No. 1, pp. 51-57, Jan. 1984.
- (11) G. Yazaki and T. Takebe, Transmission Networks and Filters, IECE of Japan, 1975.

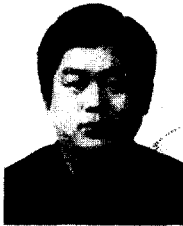

金 東 一 (Dong Il KIM) 正會員

1952年2月26日生

1975年2月：韓國海洋大學航海學科卒業

1977年2月：韓國海洋大學 大學院 電波航海學 專攻(工學碩士)

1984年3月：日本東京大學工業 大學院 電氣電子工學專攻(工學博士)

1975年3月~1978年3月：韓國海洋大學 助教

1978年4月~1984年9月：韓國海洋大學 專任講師

1984年10月~現在：韓國海洋大學 電子通信工學科 助教授

美國 IEEE, 日本電子通信學會, 日本電氣學會, 大韓電子工學會, 日本航海學會, 韓國航海學會 及 韓國港灣學會 正會員.



金 是 和 (Si-Hwa KIM) 正會員

1955年3月23日生

1978年2月：韓國海洋大學 航海學科 卒業

1982年2月：韓國海洋大學 大學院 電氣電子工學專攻(工學碩士)

1978年7月：韓國海洋大學 助教

1981年10月~現在：韓國海洋大學專任講師, 韓國航海學會, 韓國港灣學會正會員.



鄭 世 讓 (Se-Mo CHUNG) 正會員

1936年9月4日生

1959年2月：韓國海洋大學 航海學科 卒業(理學士)

1967年2月：延世大學校 電子工學科 卒業(工學士)

1971年2月：延世大學校 大學院 電子工學科 卒業(工學碩士)

1976年9月：日本東京工業大學 大學院 電氣電子工學科 卒業(工學博士)

1963年：韓國海洋大學 助教

1964年：韓國海洋大學 專任講師

1982年~現在：韓國海洋大學 教授

英國王立航海學會, 日本電子通信學會, 大韓電子工學會, 日本航海學會, 韓國航海學會 及 韓國港灣學會 正會員.