

부스트 Negative Bias를 가지는 단상 SRM 컨버터

Jianing Liang*, 석승훈*, 이동희*, 안진우*
 경성대학교*

Single Phase SRM Converter with Boost Negative Bias

Jianing Liang, Seung-Hun Seok, Dong-Hee Lee, Jin-Woo Ahn
 Kyungshung University

Abstract - At the high speed operation, the boost negative bias can reduce the negative torque and increase the dwell angle, so the output power and efficiency can be improved. In this paper, a novel power converter for single phase SRM with boost negative bias is proposed. A simple passive capacitor circuit is added in the front-end, which consists of three diodes and one capacitor. Based on this passive capacitor network, the two capacitors can be connected in series and parallel in different condition. In proposed converter, the phase winding of SRM obtains general dc-link voltage in excitation mode and the double dc-link voltage in demagnetization mode. The operation modes of the proposed converter are analyzed in detail. Some computer simulation and experimental results are done to verify the performance of proposed converter.

1. Introduction

Switched Reluctance Motors(SRM) is investigated for wide industrial applications due to the mechanical strength and cost advantages[1]. SRM has high power-to-weight, torque-to-weight ratios, a wide speed range, robust structure and intense temperature variations. So SRM is suitable for high speed application.

However, the excitation and demagnetization voltage is limited by the fixed dc-link voltage in conventional SR drive. So the fast excitation and demagnetization is very difficult to achieve in the high speed region. Even the turn on angle can be regulated to improve the output torque, but the negative torque causes low efficiency and negative torque. The high demagnetization voltage is good choice to improve the performance of SRM. The high demagnetization voltage can obtain faster reduction of tail current after aligned position, which leads to smaller the negative torque and longer dwell angle.

Boost converter is used to boost dc-link voltage. The dc-link voltage can be boosted, but this type of converter requires additional inductance, diode, capacitor, power switch and voltage detect circuit. The high cost and complicated boost voltage control method confine their applications. The two types passive boost dc-link converter are proposed[2][3]. One is two capacitors in series-connected type, and another is two capacitors in parallel-connected type. Although this two types converter are simple, and the demagnetization current charges an additional capacitor and supplies effectual boost voltage higher than the input dc-link voltage. But additional boost voltage has relationship with recovered energy in given capacitor size, so it can not be controlled in wide speed region.

In this paper, a novel power converter for single phase SRM with boost negative bias is proposed. Based on the passive capacitor network, the two capacitors can be connected in series and parallel in different state. In proposed converter, the phase winding of SRM obtains general dc-link voltage in excitation mode and the double dc-link voltage in demagnetization mode. The operation modes of the proposed converter are analyzed in detail. Some computer simulation and experimental results are done to verify the performance of proposed converter.

2. Conventional SR Motor Converter

The conventional SR drive applies a diode bridge rectifier and a large capacitor on the front-end. This capacitor keeps a steady dc link voltage as a filter. Another function of that is stored magnetic field energy after turn off angle of SR motor.

Asymmetric bridge converter is popular in SR drive, which consists

of two power switches and two diodes. The asymmetric converter has three modes, which are defined as magnetization mode, freewheeling mode and demagnetization mode. There are shown in Fig. 1.

From the Fig.1 (a) and (c), it is easy to know that amplitudes of excitation and demagnetization voltage are close to terminal voltage of filter capacitor. The fixed dc-link voltage confines the performance of SR drive in high speed application.

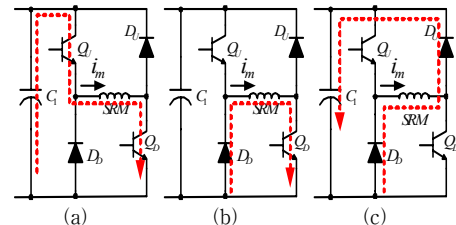

<Fig. 1> Operation modes of asymmetric converter (a) Magnetization (b) Freewheeling (c) Demagnetization

However, the high demagnetization voltage can improve high speed performance of SR drive. From Fig. 2, the advantage of high demagnetization is shown clearly. Firstly, it can reduce the negative torque. Secondly, the dwell angle can be extended. So the average torque and efficiency can be increased.

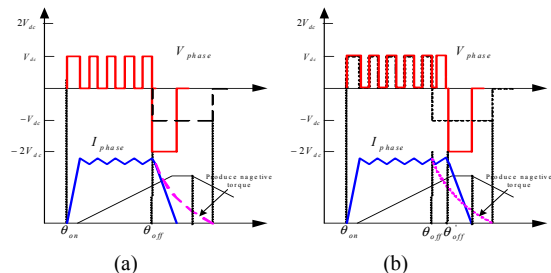

<Fig. 2> Advantage of high demagnetization voltage (a) Negative torque reduction (b) Extended dwell angle

3. Proposed Power Converter for Single Phase SRM

The proposed passive boost converter is shown in Fig. 3. Compare with conventional one, a passive capacitor circuit is added in the front-end, which consists of three diodes and one capacitor shown in Fig. 4(a). This circuit has three modes: input mode 1, output mode and input mode 2. In input mode 1, the energy of source charge dc-link capacitor C_1 from ab terminal so voltage of C_1 keeps the balance with source. In output mode, two capacitors and diodes compose two independent voltage sources in parallel, and the output voltage of cd terminal is equal to maximum voltage of them. In input mode 2, the energy input from cd terminal. Diode D_2 turns on, and input current charges two capacitors. So two capacitors are connected in series, and voltage of cd terminal is superposition of them.

Based on this passive network, when asymmetric converter works in excitation mode, the two capacitors connected in parallel. When in demagnetization mode, the two capacitors connected in series. So the phase winding of SRM obtains general dc-link voltage in excitation mode and the double dc-link voltage in demagnetization mode.

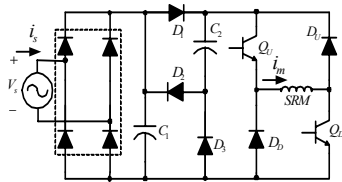

<Fig. 3> Proposed passive boost converter

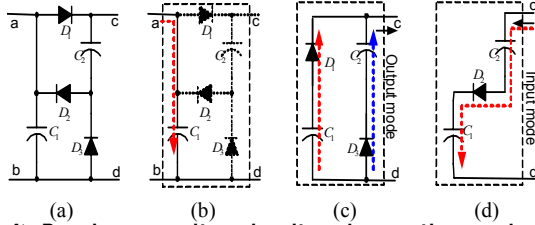

<Fig. 4> Passive capacitor circuit and operation modes
(a) Passive capacitor circuit (b) Input mode 1
(c) Output mode (d) Input mode 2

To analyze the operation of the proposed converter in single phase SR operation, the converter is divided into five modes from different states of switches, i.e. boost capacitor excitation mode, dc-link capacitor excitation mode, two capacitors excitation mode, freewheeling mode and fast demagnetization mode, respectively. There are shown in Fig. 5.

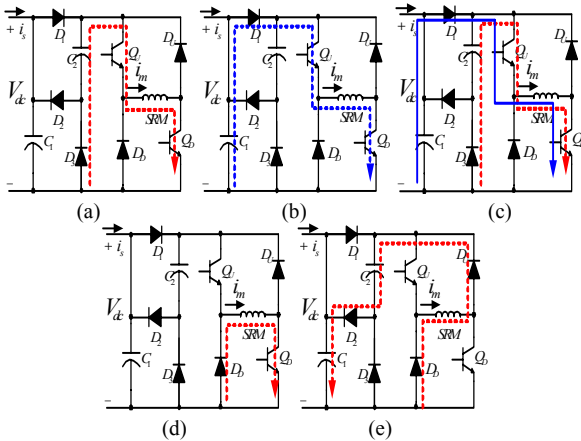

<Fig. 5> Operation modes of proposed converter
(a) Boost capacitor excitation (b) Dc-link capacitor excitation
(c) Two capacitors excitation (d) Freewheeling
(e) Fast demagnetization

<Tab. 1> The operation modes of proposed converter

Mode	Voltage States	Switch States	Phase Voltage
Excitation-1	$V_{C_1} < V_{C_2}$	(Q_u, Q_d, D_3) on $(D_1, D_2, D_4, D_5, D_6)$ off	$V_{C_2} - V_D - 2V_\phi$
Excitation-2	$V_{C_1} > V_{C_2}$	(Q_u, Q_d, D_1) on $(D_2, D_3, D_4, D_5, D_6)$ off	$V_{C_1} - V_D - 2V_\phi$
Excitation-3	$V_{C_1} = V_{C_2}$	(Q_u, Q_d, D_1, D_3) on (D_2, D_4, D_5, D_6) off	$V_{C_2} - V_D - 2V_\phi$
Freewheeling		(Q_d, D_3) on $(Q_u, D_1, D_2, D_4, D_5, D_6)$ off	$-(V_D + V_\phi)$
demagnetization		(D_4, D_5, D_6) on $(Q_u, Q_d, D_1, D_2, D_3)$ off	$-(V_{C_1} + V_{C_2} + 3V_D)$

Compare with asymmetric converter, the excitation mode has been separated to three modes from different boost capacitor voltage. The voltage states, switch states and phase voltage are shown in Tab. 1.

4. Simulation and Experimental Results

In order to verify the performance of proposed converter, the proposed converter has been simulated using Matlab/Simulink. The contrastive simulation results of conventional and proposed converter have been shown in Fig.6. The double dc-link demagnetization voltage is shown in simulation result clearly. The high demagnetization voltage of proposed converter obtains a short tail

current and reduces the negative torque after the aligned position.

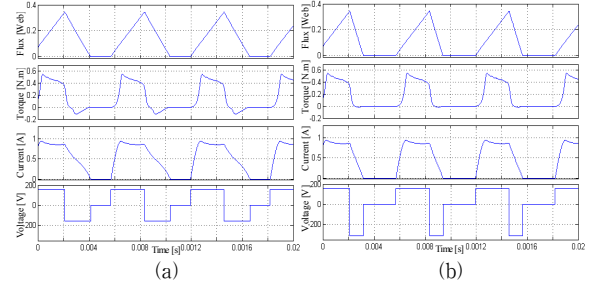

<Fig. 6> Two converters operate single pulse control
(a) Conventional converter (b) Proposed converter

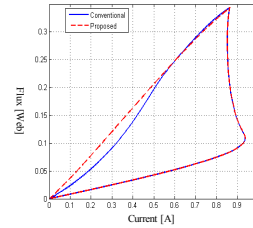

<Fig. 7> Flux versus current trajectory in single pulse control

The increased output power can be seen from the increased area enclosed by the flux versus current trajectory shown in Fig. 7. The improvement of output power is shown clearly.

The experimental results of proposed converter are shown in Fig. 8. The PWM and single pulse control is shown in Fig. 8(a) and (b). The voltage of boost capacitor is stable, and double dc-link demagnetization voltage is obtained.

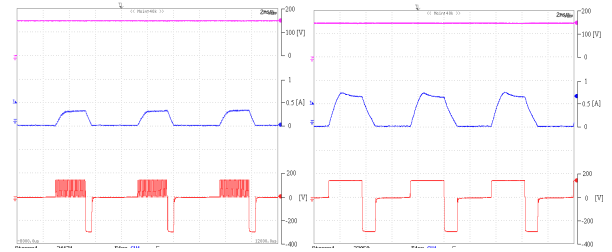

<Fig. 8> Experimental results of proposed converter
(a) PWM control (b) Single pulse control

5. Conclusion

In this paper, a novel power converter for single phase SRM with boost negative bias is proposed. A passive capacitor circuit is added in the front-end. The some passive components are required, and the voltage rate of power switch need to increased. That will increase some cost of converter. However, based on this passive network, the two capacitors can be connected in series and parallel, the double dc-link voltage in demagnetization mode can be obtained. Due to high demagnetization voltage, the efficiency and output power can be improved. Some computer simulation experimental results have been done to verify the performance of proposed converter.

Acknowledgment

This work was supported by the Brain Busan 21 Project in 2007.

[References]

[1] R. Krishnan, "Switched Reluctance Motor Drives: Modeling, Simulation, Analysis, Design, and Applications", CRC Press, 2001
 [2] Dahmane, A.; Meebody, F.; Sargos, F.-M.; "A novel boost capacitor circuit to enhance the performance of the switched reluctance motor", Power Electronics Specialists Conference, 2001. 17-21 June 2001 Pp:844 - 849 vol.2
 [3] Chan, S.; Bolton, H.R.; "Performance enhancement of single-phase switched-reluctance motor by DC link voltage boosting", Electric Power Applications, IEE Proceedings B Vol 140, Issue 5, Sept. 1993 Pp:316 - 322 vol.2