

초청강연

Some Case Studies of Hydrodynamic Bearings in Power Plants in Japan

Professor. Tanaka, Masato, Dr. Eng.

(President of JAST/Univ. of Tokyo)

Some case studies of hydrodynamic bearings in power plants in Japan

Tanaka M.^a

^a *University of Tokyo, Dept Mechanical Engineering & Engineering Synthesis, 7-3-1, Hongo, Bunkyo-Ku, TOKYO 113-8656, Japan.*

The service reliability of power plants strongly depends on the excellent performance and integrity of hydrodynamic bearings. Consequently, the bearings must be properly designed so as to control vibration amplitudes of rotor due to mass unbalance in passing critical speeds and also suppress self-excited vibrations of rotor even over maximum rated speeds. Furthermore, the bearings must be designed so as to maintain required tribological performance even under severe operating conditions. However, various tribological troubles have been experienced in power plants in Japan. The actual troubles are analysed, focusing on not only direct mechanical causes but also specific bearing designs that surfaced the troubles. Furthermore human factors that decided such designs are also studied. The powerful database of troubles and analyses will contribute greatly to designing advanced power plants with enhanced service reliability in the future. To this end, trouble information should be disclosed, shared and transferred limitlessly. Cooperation of users of power plants is essential to making more advanced design specifications, because no one has easier access to operating and trouble information of power plants than users.

Keywords : Journal bearing, thrust bearing, oil seal, damage, tribology, steam power plant

1. INTRODUCTION

Steam turbine power plants consist of various types of rotating machinery. When tribological troubles take place in bearings of the machinery in operation, the plants may have to reduce power output or even completely shut down, resulting in large-scale social inconvenience or critical damage to some electric-powered systems.

On the other hand it is usually very difficult to take corrective actions to operating machinery because there may be left only few options of feasible design modification and also because each of them often costs much. Consequently, it is very important to design bearings that can be operated free from various tribological troubles. To this end, engineers need to make the most of the state-of-the-art of tribology. However, the knowledge sometimes fails to be applied properly or troubles cannot be often predicted easily when new machinery of higher performance and/or of larger size is designed.

Thus some tribological troubles inevitably take place after machines have been commissioned. Then, it would be sensible to learn and make use of the lessons from the troubles experienced in machinery in practical use for better design of future machinery. Consequently those troubles must be correctly and skillfully analysed, recorded in detail, and furthermore the information must be prepared to be easily accessible to be shared widely.

However when a trouble took place in actual machinery in Japan, it was usually taken care of very covertly. No one except a small group of the maker and the user involved could know what caused the trouble and how it was sorted out. Even the fact that the trouble actually happened did not come out unless it caused casualties or public inconvenience widely. Furthermore the files were kept in the depth of cabinet of the company, and the access to that information was strictly limited.

A trouble is regarded in general as a synonym of insufficient engineering skill or incompetence of the inexpert manufacturer involved, even if it is actually an unlucky result of challenging a difficult target of technology. Consequently, the manufacturers involved have made every effort to conceal the trouble from the public, trying to avoid the disgrace of being humiliated. The codes of conduct are deeply related to the traditional culture of Japan.

Consequently the same or similar troubles took place deplorably in different machines or at different companies many times. This should be regarded as unnecessary loss that could have been avoided by disclosing the information to be shared among management, design engineers, maintenance engineers and academics across company borders and industry-university borders.

The Turbomachinery Society of Japan established a Sub-Committee on Tribology in Steam Turbine Power Plants in 1995. Since then, the Sub-Committee of 20 members from industries and a university, held twelve meetings to investigate, discuss and share various case studies related to tribological problems experienced in steam turbine power plants in Japan. The problems covered a variety of machine elements, components and systems, such as journal bearings, thrust bearings, rolling element bearings, seals, gears, valves, lubricants and lubricating systems.

By doing these activities, the Sub-Committee aimed for a large contribution toward saving time and money that may otherwise need to troubleshoot similar tribological problems repeatedly in different companies. Furthermore the Sub-Committee also contributed largely to expediting to better design of future machinery, and also to extending the limits of the knowledge of tribology.

2. CASE STUDY FORMAT

Each case study of tribological trouble was submitted in the common format prescribed by the Sub-Committee. The format consists of nature of the trouble, name of machine or component in trouble, phenomena observed, causes assumed, analyses conducted, measures taken, references if any, and lessons derived. However the names of the manufacturer and the user involved were not disclosed. The date when and the place where the trouble occurred were not disclosed either.

3. FAILURE MODES AND CAUSES

The tribological troubles observed take various types of failure mode, such as seizure, wiping, excessive wear, excessive degradation, fatigue crack, creep fracture, stick, galling, excessive vibration or noise, oil leak and so on. The primary (direct) causes of the troubles were identified with uneven contact, insufficient minimum oil film thickness (excessive load), electrical pitting, insufficient wear resistance of materials, pileup of carbonised oil, pileup of scale or excessive deformation.

These primary causes have been well known and analysed since long before, and engineers should know how to design machinery in order to prevent these primary causes from rising to the surface. Nevertheless, these causes often bring about tribological troubles in actual machines. There may be something wrong.

4. INITIATOR AND PROMOTER

Figure 1 shows why so many troubles take place in actual machines even though design engineers make the most of the state-of-the-art knowledge of tribology. There may be an initiator that triggers off the chain of events finally making the trouble rise to the surface. A promoter may expedite the chain reaction at one stage or another. Among this chain of causes and results, the events closest to the troubles are easy to recognise as the primary or direct causes listed in the previous section.

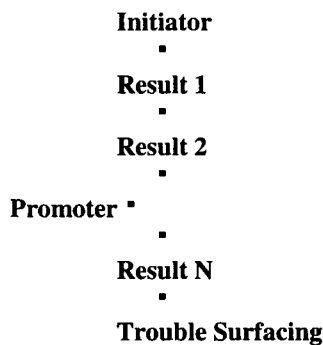

Fig.1 Chain of cause and result

- 1. Fail to Notice**
- 2. Fail to Connect**
- 3. Fail to Estimate**

Fig.2 Three modes of human error

As the direct causes always have strong appeal to engineers, it is dangerous to pay too much attention to these

near-surface causes only. It is much more important to track down the chain of events, find and remove the initiators and the promoters, or disconnect the chain of events leading to the troubles at the final stage. However, it is usually difficult to reconstruct the chain of events and reach the initiators or the promoters because the chain of events is often very long and complicated.

The analyses of the case studies show that the initiators and the promoters are insufficient stiffness, inappropriately selected material, excessive repetitions of startup and shutdown, inappropriate design modification, insufficient bearing alignment and so on. The lessons derived from the case studies show that design engineers, maintenance engineers or management failed to stop the final catastrophe because of human errors.

5. HUMAN ERRORS

Human errors appear in the following way. The latent initiators and the latent promoters were not noticed at the design stage. Or they were not connected with the final primary causes by mistake, perhaps because the long chain of events was complicated and difficult to construct, understand and follow. Or their effects were estimated acceptably little by mistake. Consequently, there are three modes of human errors, that is, fail to notice, fail to connect and fail to estimate (Fig. 2). These reasons may explain why so many tribological troubles take place repeatedly in actual machines in spite of so much knowledge of tribology and a large pile of hard experiences.

6. CASE STUDY

6.1 Case NO.1

The first case to be discussed is journal bearing seizure which happened in a steam turbine power plant of 500 MW in output. The operation monitoring system announced high temperature warning of the pad surface and discharged oil in a sleeve bearing installed in a low-pressure turbine during startup. When urgently stopped and inspected, and seizure and heavy uneven contact were found on the pad surface.

Figure 3 shows a schematic of the damaged surface of the bearing pad. There are oil discharge ports in the grooves at both bearing ends. Seizure is found to have taken place on most part of the pad surface, and the jack-up oil groove is filled with Babbitt metal that melted, flew and solidified again. Heavy contact is observed on the governor side, while light contact is found on the generator side.

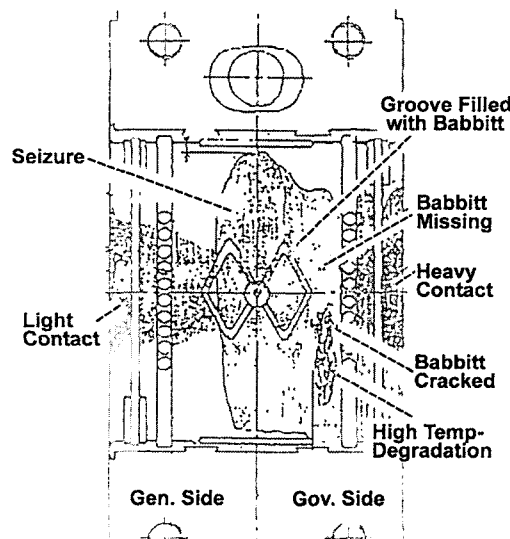

Fig.3 Damaged surface of journal bearing

Fatigue crack of bearing metal was ruled out because macroscopic and microscopic inspection found neither pinholes nor casting defects. Chemical composition and hardness of the bearing metal were found to be normal.

The primary (direct) cause is that the hydrostatic oil film failed to develop because the high oil pressure could not be maintained due to large bearing clearance on the generator side that resulted from excessive bearing tilt angle. However the initiators that triggered the chain reaction were the reduction of bearing width carried out to suppress oil whip that had happened in this turbine before, and also the large jack-up oil groove unchanged in

spite of the width reduction. Hydrostatic oil film can be easily developed with a large oil groove, but in this case the jack-up oil system was not effective because of its large groove size. The reduction of the bearing width resulted in the decrease in the restoring moment of oil film. The expediting promoter was a tight clearance of the spherical key of the bearing (Fig. 4), resulting in the excessive angular misalignment of bearing.

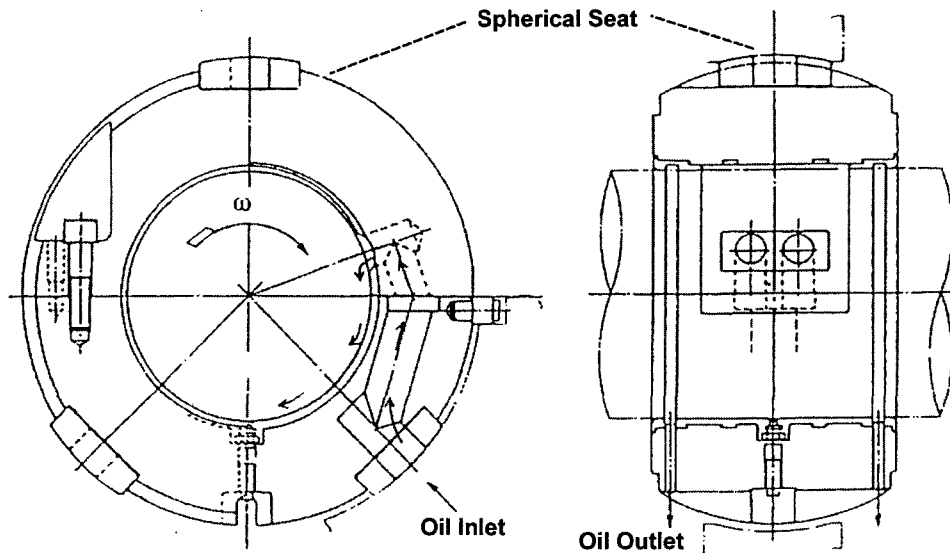

Fig.4 Spherical key of journal bearing

Trouble shooting was carried out as follows. The jack-up oil groove was reduced in size to keep high pressure easily even with a large clearance due to bearing tilt. The spherical seat clearance was increased by 0.1 mm for easy tilt movement of the bearing when applied by restoring moment of oil film in spite of possible clearance reduction due to thermal dilation of the bearing. These countermeasures worked well.

The shape and size of jack-up oil groove is confirmed technique, and the reduction of bearing width is a familiar countermeasure against oil whip. However the lesson derived from this case is that you cannot see the wood for the trees, and new examination is needed when two well-established methods are combined even though both of them are mature technologies.

Fail to Notice and also Fail to Connect can be detected in this case.

Poorly working spherical seats are reported to have caused many similar troubles of journal bearing. The dimension of the spherical seat clearance is difficult to decide because bearing housings usually dilate and/or deform due to temperature change. Furthermore, friction between keys and seats cannot be predicted accurately, because the friction mode is boundary lubrication or dry friction. Basic studies are needed to unravel these uncertain factors which are often omitted to go over at the design stage.

6.2 Case NO.2

The second case is wiping of Babbitt of a two-lobe bearing used in a steam turbine of 350 MW.

During startup, the operation monitoring system announced high temperature warning of bearing metal, and the thermometer for a journal bearing was found to read 135 degree. The bearing was inspected and wiping was found on the lower pad. The width of light contact was wider than normal. Furthermore, the surface roughness of the journal was found to have increased. Before the trouble happened, stick-slip rotation of the journal had been observed to take place during turning operation.

From these phenomena, local breakdown of oil film was assumed to cause this trouble. This unit experienced more than 700 DSS (Daily Startup and Shutdown) operations. A thick oil film could not be maintained at the journal bearing in turning operations during nights because a jack-up oil system was not equipped with this unit. Consequently, partial metal-to-metal contact takes place frequently between the journal and the bearing pad and surface damage can be assumed to progress both on the bearing pad and on the journal with the increase in DSS operation.

For countermeasures, the rough journal surface was smoothed to minimise metal-to-metal contact even during low-speed turning operations, and a new journal bearing was installed. Furthermore, the turning speed was increased from 3 rpm to 7 rpm to increase the hydrodynamic oil film thickness. If a journal surface is rough,

it is difficult to separate the journal from bearing pad with hydrodynamic oil film at low shaft speeds. The journal surface roughness is recommended to be as small as 0.2 micrometer in R_{max} .

The surface damage of bearings and journals should have been assumed to progress rapidly, because DSS operation accelerates the surface damage without a jack-up oil system. However, inspection was conducted in the same way as when the unit had been operated continuously in the base load mode. Maintenance procedure should be immediately modified when the operation modes change.

Fail to Notice can be detected in this case.

6.3 Case NO.3

The third case is complete Babbitt loss of thrust bearing that took place in a steam turbine for pump driver. An excessive axial displacement of shaft was detected during startup, and the turbine was automatically stopped. The thrust bearings showed complete meltdown loss of Babbitt.

This impulse-type steam turbine generates small thrust force inherently. The supply pressure of lubricant and the temperature of discharged oil were normal. Contamination level of lubricant was very low. Consequently, the thrust bearing was presumed to operate with sufficient oil film thickness.

Another unit of identical design was inspected, and spark tracks of 0.5 to 1.5 mm in depth and frosting damage were observed on thrust pad surfaces (Fig. 5). Consequently electric pitting was assumed to trigger the meltdown trouble.

Carbon brushes are usually installed to ground or earth rotors (Fig. 6). However carbon brushes were found not to maintain good contact with the rotating surface because of soft spring pressure. This is the initiator that triggered the chain of events. Furthermore, two promoters were found, that is, oil film formed in the brush tip clearance increased the electric resistance of the contact point, and the turbine thrust force acted so as to separate the contact.

For countermeasure, the design of the carbon brush unit was changed, and an oil-free contact point was newly selected for the brush.

The lesson derived from this case is that even an existing preventive device should be carefully checked for functioning properly.

Fail to Notice can be detected in this trouble.

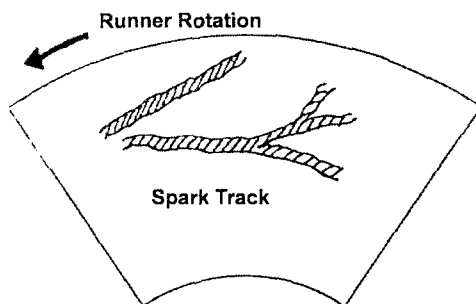

Fig.5 Electrical Pitting on thrust pad

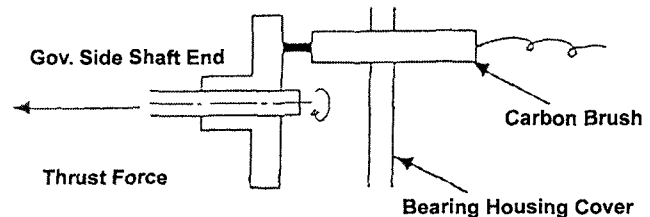

Fig.6 Carbon brush earth

6.4 Case NO.4

The fourth case is surface damage of thrust bearing pads used in a steam turbine of 65 MW output.

The metal temperature thermometer was found to read 35 degree above the supply temperature during startup and also to read higher with the increase in power output. When inspected, surface damage was found on the land part of lower pads, while the tapered part was discoloured. Furthermore, a circumferential scar was found on the outer peripheral part (Fig. 7), and some metal debris was found in the strainer of the lubricating system.

The initiator is the increase in thrust load, compared to that of the original turbine of 30 MW. When the steam turbine of higher power output of 65 MW was designed, the thrust load was regarded unchanged, resulting in using a thrust bearing of the same design. However the thrust load actually increased, because of higher contribution of the reaction stage.

Each pad was made so that the original clearance should decrease gradually from the inner periphery to the outer periphery in order to increase load carrying capacity of the bearing. However, operating clearance calculated at the outer periphery was found too small, and local deformation of the pad assembly due to high operating temperature rise there may have decreased the oil film thickness, causing metal-to-metal contact. This is regarded as one of the promoters.

This thrust bearing is also affected by the operating condition of the journal bearing because both bearings are contained in the same housing (Fig.8). When the bearing casing moves vertically due to temperature change and the spherical seat of the journal bearing does not work well, thrust pads are loaded unevenly because of misalignment. Then excessive load would be applied to the lower pads, and this is regarded as the possible primary cause of the surface damage. On the other hand, poorly working spherical seats are regarded as another promoter.

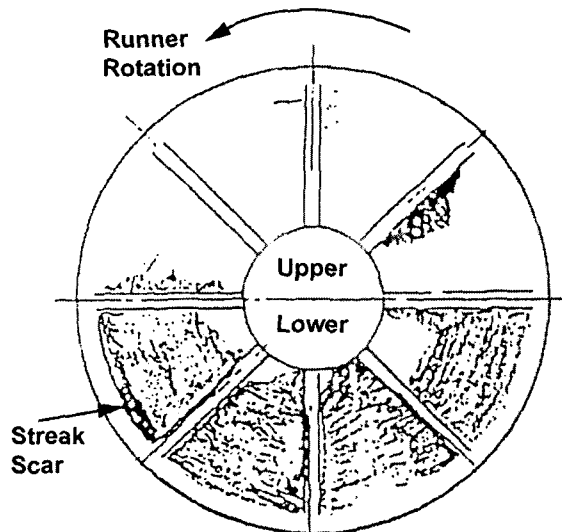

Fig.7 Damage on lower thrust pads

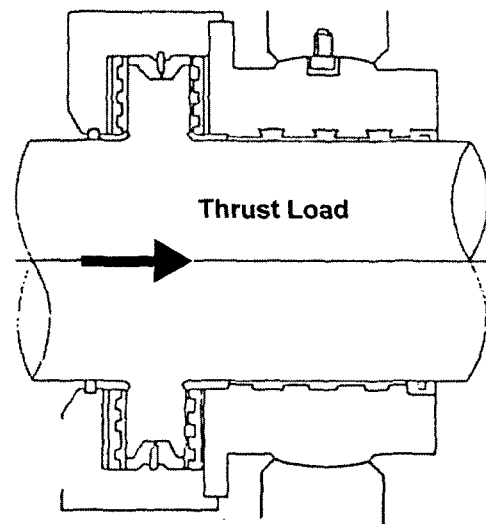

Fig.8 Bearing housing

For countermeasures, the spherical seat clearance was increased from 20 micrometer to 40 micrometer in order to ensure the bearing alignment more easily. The thrust bearing clearance at the outer periphery was increased to 80 micrometer to avoid local thermal deformation and direct metal-to-metal contact even at high operating temperatures. Furthermore, another pair of thermocouples was newly installed to detect uneven loading from temperature difference measured. One pair of thermocouples is difficult to detect uneven loading quickly.

The lesson derived from this trouble shows that every effect of upsizing must be carefully examined even if a reliable design is adopted.

Fail to Notice and Fail to Estimate can be detected in this case.

A similar trouble took place in another steam turbine of 185 MW. The thrust load was found to have increased by 13 tonf, compared to the original value, 14 tonf, because main steam flow was increased as various clearances increased due to wear caused by long-time use. Attention must be paid to thrust load that may change due to aging.

6.5 Case NO.5

The fifth case is fatigue crack of Babbitt metal on a seal ring surface. Large generators often use pressurised hydrogen gas to remove internal heat, and oil film seals are installed to seal the gas by forming high-pressure oil film between the journal and the seal ring. Consequently the inner surface of seal ring is lined with Babbitt metal like journal bearings. On a regular inspection of a large 4-pole generator, the Babbitt metal surface of seal ring of 600 mm in diameter showed fatigue crack.

From experiments conducted with a model seal ring of actual size, the seal ring was found to deform elliptically due to non-uniform thermal distribution. Furthermore, the axis of the elliptical shape was found to rotate with time. The period of one revolution was found to be 99 seconds. This periodical deformation yields cyclic loading to the Babbitt metal, and is presumed to be the primary cause.

Thermo-hydrodynamic analyses revealed that this cyclic deformation was a self-excited oscillation that takes place when some conditions are satisfied [1]. Figure 9 shows the schematic of the cyclic deformation. The seal clearance corresponding to the ring shape defined by the solid line at one time prepares the ring shape defined by the broken line at the time of next step. The key factor of this phenomenon is the difference of the circumferential positions of the minimum film thickness and the maximum oil film temperature.

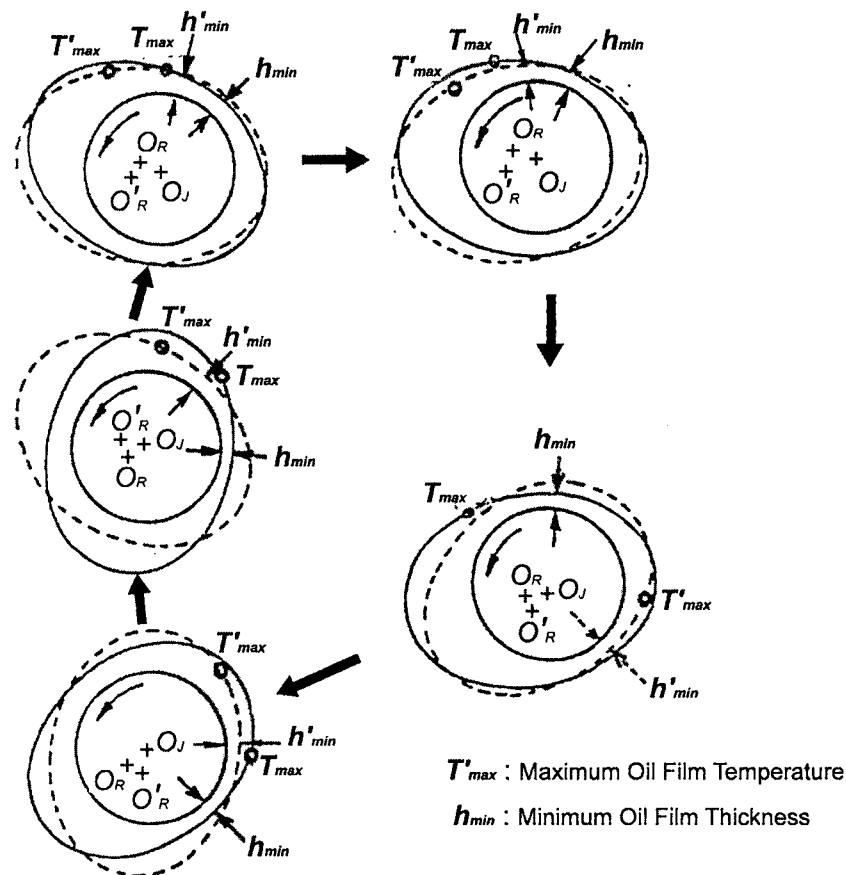

Fig.9 Cyclic thermal deformation of seal ring

On the other hand, the initiator was designing a seal ring with the same section area unchanged and with the diameter increased, based on the design of a seal ring of small size for 2-pole generator. Therefore the bending stiffness of the seal ring was insufficient, resulting in large deformation. The promoter was a large amount of heat generation due to a small seal clearance and also the high viscosity of sealing oil.

For countermeasure, the seal ring section area was increased by about 50 %, resulting in the increase in bending stiffness. Furthermore, the seal clearance was increased and the supply temperature of sealing oil was increased, which reduced heat generation in the oil film and suppressed the self-excited oscillation.

The lesson derived from this trouble shows that a nonlinear effect of upsizing must be carefully examined in the design.

Fail to Notice and Fail to Estimate can be detected in this case.

6.6 Case NO.6

The sixth case is rubbing vibration of rotor found in a steam turbine. The vibration of the HP-IP rotor started to take place repeatedly every two hours, although its power output was not changed.

Rubbing vibrations of rotor are widely known to take place in steam turbines when power output is changed. Rotors tend to contact steam labyrinth seals when rotors move position in the rotating plane with changing output. However, this case was not related to power change.

When inspected, mixture of lagging dust and carbonised oil was found in a labyrinth oil seal installed by the journal bearing housing on the high-pressure turbine side (Fig. 10). The temperature measured at the seal was about 160 degree. A reproduction experiment showed that oil started to carbonise when the temperature exceeded 170 degree. Lagging dust lowered the critical temperature that starts carbonisation.

The primary cause of the rubbing vibration is the pileup of dust and carbonised oil in the seal. When the pileup increases in amount, the shaft contacts the hard substance and the rubbing vibration starts. Then, the pileup comes off and the vibration stops, but the pileup restarts again. This explains that the vibration repeats intermittently with the period of about two hours. There are three elements of oil, dust and high temperature that make the pileup at the seal.

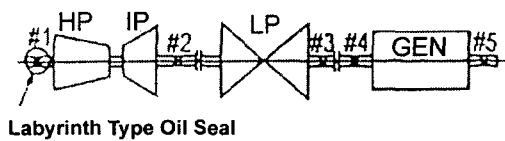

Labyrinth Type Oil Seal

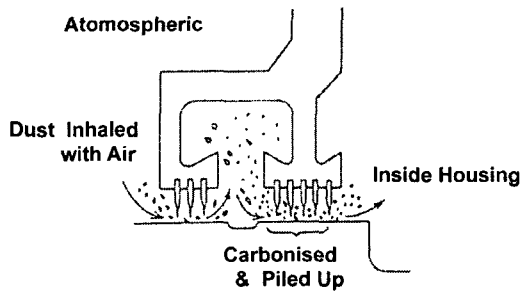

Fig.10 Conventional oil seal

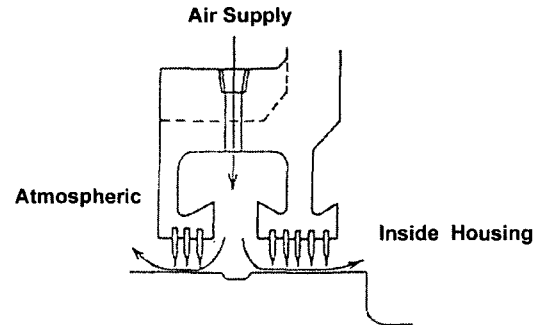

Fig.11 New oil seal

The initiator is the sub-ambient pressure in the bearing housing that induces air flow from outside, and dust of lagging material comes with the air. The dust is trapped by the labyrinth blades and absorbs some oil droplets coming from the other side. Oil component carbonises due to the high environmental temperature at the seal position, and a hard substance is left. The sub-ambient pressure in the bearing housing must be kept to prevent oil from coming out of the bearing housing. If the pressure is very low, no oil would come into the seal section to carbonise there, but much dust would come into lubricating oil. Consequently, the set pressure was not low enough, and some amount of oil leaked into the seal section. It is a trade-off problem.

Similarly, if a too small seal clearance is selected in order to reduce the amount of dust from outside, even a small amount of pileup would trigger the rubbing vibration. On the other hand, a too large clearance would increase the amount of incoming dust. It is another trade-off problem to select the seal clearance.

Fail to Estimate can be detected in this case.

Figure 11 shows a newly designed oil seal. Pressurised air is supplied to decrease the seal temperature and also to purge both of oil droplets coming from inside and lagging dust coming from outside.

7. DISCUSSION

The analyses of the case studies show that the tribological troubles took place not because of low quality of materials or lubricants used but because of design problems. The technologies for steam turbine power plants are mature in general, and most tribological machine elements and lubricants, when properly designed, can well exceed required levels of performance and life nowadays.

On the other hand, operating conditions of some part of the plant are not well identified, and required performance cannot be clearly defined. Therefore, except for some vital part, design criteria, inclusive of properly selecting materials and lubricants, are not well established. Design engineers should be given more information of high quality to make correct decisions. To this end, affirmative cooperation on the side of users is essential. Similar discussion can be presented with regards to vibration troubles [2].

Section 5 discussed the three modes of human errors at the stage of designing, and various lessons were listed in the cases described in Section 6. Some more lessons obtained from the troubles are as follows: Do not change the original design without knowing details of know-why. Pay attention to the actual operating conditions different from the assumed conditions at the design stage. Do not rush to new design to reduce costs. Beware of performance limit of materials and out-of-date maintenance criteria.

8. CONCLUDING REMARKS

The Sub-Committee collected and analysed various tribological troubles encountered in actual steam turbine power plants in Japan. Some of the cases and the lessons obtained were discussed and the following conclusions are obtained.

(1) The Sub-Committee's successful activities greatly contribute to better tribological design of future steam

turbine power plants, and also to preventing similar tribological troubles from taking place repeatedly in different companies, thus saving money and time that otherwise would be needed to troubleshoot at each time.

(2) The information on troubles experienced in actual machinery should be analysed and shared limitlessly for better design of future machinery free from tribological troubles and also for the development of tribology.

(3) The similar activities are encouraged worldwide to make the troubleshooting database more powerful to establish better design of machinery.

(4) The tribological troubles in actual machinery are found to emerge because of human errors in adopting or modifying specific design. The initiators and the promoters of various latent troubles are often difficult to notice or estimate accurately, compared with primary causes and also difficult to link with primary causes of the troubles.

(5) Tribological troubles could be reduced in number in the future when operating conditions of actual turbine power plants are identified more precisely and supplied with design engineers to refine design criteria. To this end, affirmative cooperation on the side of users is essential.

ACKNOWLEDGEMENT

The author would like to thank President Kim, Dong-Soo of KSTLE and his colleagues for kindly giving the author the opportunity of presenting a special lecture at KSTLE Fall Annual Conference 2003 held in Suwon.

REFERENCE

[1] Oishi, N. and Tanaka, M., Periodic Thermal Deformation of Large Seal Ring, *JSME International Journal*, Series C, 39, 2 (1996) 347-353.

[2] Tanaka, M., Rotordynamic Problems Experienced in Actual Machines, *Proceedings of 5th IFToMM International Conference on Rotor Dynamics*, 1 998, Darmstadt, 68-82.