

Design of On-Board Computer System for Korean High-Speed Train

한국형 고속전철의 차상컴퓨터시스템 설계

Lee, Joo-Hoon* Lee, Jae-Duck* Cho, Chang-Hee* Jeon, Jeong-Woo*

이 주 훈 이 재 덕 조 창 회 전 정 우

Park, Doh-Young* Kim, Kook Hun* Kim, Yong-Joo*

박 도 영 김 국 현 김 용 주

한글 요지

현재 KERI의 고속전철 T.F.T.는 최고속도 350kph를 목표로 하는 한국형 고속전철 개발과 제에 참여하고 있다. KERI의 연구분야는 전기시스템 엔지니어링으로, 열차의 전기 및 기계 시스템의 진단 및 제어를 수행하는 차상컴퓨터시스템의 엔지니어링 설계를 포함하고 있다. 본 설계는 승객의 안전과 제작, 운전, 유지보수 단계에서의 경제성 확보라는 측면에 시스템 엔지니어링 개념을 두고 있다.

본 논문에서는 한국형 고속전철(KHST)의 안전성과 신뢰성을 책임지는 차상컴퓨터시스템의 엔지니어링 설계안을 제시한다. 본 설계안은 네트워크를 통한 분산처리시스템에 초점을 맞추고 있다.

1. Introduction

Due to the increase of train speed, verification of safety is greatly emphasized. The safety is guaranteed by on-board computer system with high performance and reliability. The on-board control system performs monitoring the train system and devices, processing the diagnosis algorithm and control the actuators. When the train is running at high speed, a malfunction and/or a reaction delay of on-board control system could result in an accident.

In the high speed train, the number of objects to be monitored is increased and the diagnosis algorithm is complex. Relayed control logic is not efficient for on-board control system because an exorbitant number of relays and hardwires are required for the system. It causes not only an economic problem but also a burden of increasing train weight.

Due to the rapid progress of microprocessor and communication technologies, the microprocessor is adapted for on-board control system. It is called an on-board computer system. The on-board computer system is more economically viable than relayed control system. The remote diagnosis and control can be performed by the network based computer system. In the maintenance stage, the remote monitoring is very efficient in analyzing the records of train system. A few technicians can perform maintenance routine for a full train set with shorter time than hardwire based relayed control system.

2. Korean high-speed train

In 1996, KHST project funded by Korean government and several companies is launched in order to develop a high speed train, called KHST-20, whose maximum speed is 350kph with 20 vehicles. It will substitute train sets of TGV-K line and run new lines. The KHST prototype, called KHST-7, is consisted of 7 vehicles, which are 2 locomotives, 2 motor coaches and 3 trailer coaches. Figure 1 shows the configuration of KHST-7 emphasizing traction and braking systems.

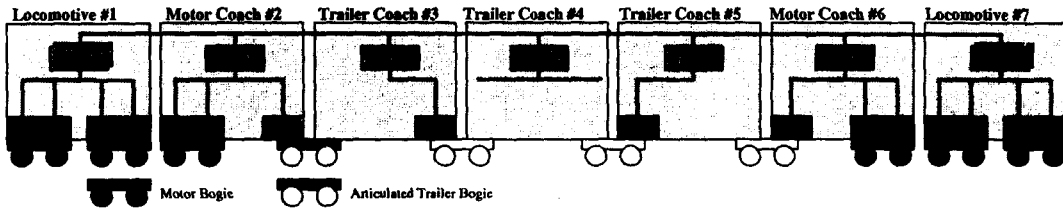

Figure. 1 KHST-7 configuration

There are six motoring bogies and four articulated trailer bogies. Each motor bogie has a motor block. A Traction Control Unit (TCU) performs diagnosis and control of a motor block with two motors. TCU is in charge of not only traction but also electric braking which is combined with regenerative and rheostat braking. There are three types of Brake Control Units (BCUs) because there are three kinds of mechanical braking systems. The motoring bogie of locomotive has a BCU-1 that performs diagnosis and control of 4 shoe braking systems. The motoring bogie of motor coach has a BCU-2 for diagnosis and control of two wheel disc braking systems. And six disc brakes controlled by BCU-3 are installed on each articulated trailer bogie. The center trailer coach #4 dose not have any TCU and BCU. The traction and braking systems of KHST-7 are listed in Table 1.

Table 1. Traction and braking system of KHST-7

	Locomotive #1 & #7	Motor Coach #2 & #6	Trailer Coach #3 & #5	Trailer Coach #4	Total	
Motor Bogie	2	1			6	2 per a locomotive 1 per a motor coach
Motor Block	4	2			12	2 per a motor bogie
Trailer Bogie		1	1		4	1 per a motor coach 1 per a trailer coach #3 and #5
Regenerative Brake	2	1			6	1 per a motor block
Rheostat Brake	2	1			6	1 per a motor block
Eddy Current Brake		1	1		4	1 per a trailer bogie
Disc Brake		6	6		24	3 per a trailer axle
Wheel Disc Brake		2			4	1 per a motoring axle of motor coach
Shoe Brake	8				16	1 per a wheel of locomotive

3. On-board control system

3.1 Design concept of on-board control system

The design concept for the on-board control system is safety. In general the safety can be ensured by; multiplicity, distribution, margin, cooperative control and mutual watch. One or a combination of the above methods is implemented into a device depending on its functions and purpose.

The multiplicity is divided into full duplex, hot standby, cold standby and single system. Depending on the systems gravity one of the multiplicity design is selected. Systems related to the safety must have redundancy. Those are ATC, brake, supervisory control unit, and so on. Distributed system reduces the load of central system and hinders propagation of a fault. Diagnosis and control for the remote devices can be performed efficiently. When there is an important decision for a control action, two units can cooperate for enhancing reliability. When two units perform the same control algorithm for separate actuators, by monitoring each others output (mutual watch) one unit can control the others actuator when the other does not work properly.

Design concept for safety will be shown in a sample brake control system for an example. Figure 2 shows block diagram of a brake system. There are three control units and actuators. Unit 1 and unit 2 control the actuator 1 and 2 respectively. The actuator 1 and 2 perform the same action in the same condition. It can be designed as unit 1 controlling both actuators, which could not control any actuator in case of unit 1s having fault. To avoid this, the system is designed to have two units resulting in a kind of distributed system.

Each actuators operation is fed back to both control unit 1 and 2 for mutual watch. When actuator 1s action is not monitored by unit 2, the unit 1 is considered as out of order by unit 2. Then unit 2 increases the actuator 2s braking power to compensate the lost power by actuator 1. For this algorithm, actuators 1 and 2 have larger maximum braking power than the rated power as margin. It can be also be designed as having only one input. For redundancy, input 1 is assigned as braking apply signal and input 2 as release signal.

Unit 3 is a brake blending unit which performs the braking power blending for effective brake control of train set. Input 3 is an emergency braking signal from supervisory control unit (SCU). And actuator 3 is a different type of braking system which is only active when emergency braking is applied. In the normal braking mode, unit 3 adds or subtracts the braking power of actuators 1 and 2 for adaptive control. And in the emergency control mode, it controls the actuators to output the maximum braking power.

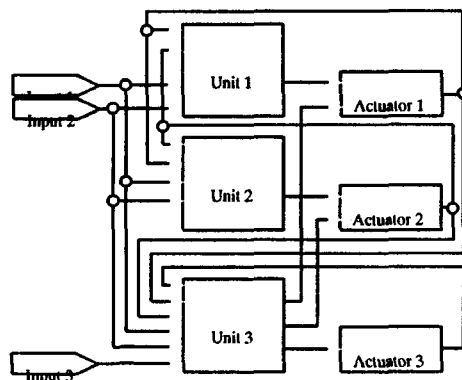

Figure 2 Block diagram of control system

For safety and reliability, a brake system is designed with multiple control signals. The actual braking system has several requirements including ensuring of the emergency braking distance under partial faults. The following requirements must be satisfied;

- The braking system is designed with margin.
- Mutual watch is needed between brake control units.
- The redundancy control signals must be installed.
- Cooperative control is needed with supervisory control unit, traction control unit and brake blending unit.

This design concept can guarantee the safety.

3.2 Design concept of Network based on-board computer system

The control system shown in figure 2 can be realized as hardwired relay logic system. But it needs an enormous cables for control signals and diagnosis information through full train set. It is not cost effective and causes the train weight to increase. It is very difficult to perform the maintenance routine for the system.

Figure 3 shows the block diagram of a control system with network interface which performs the same control actions of the system shown in figure 2.

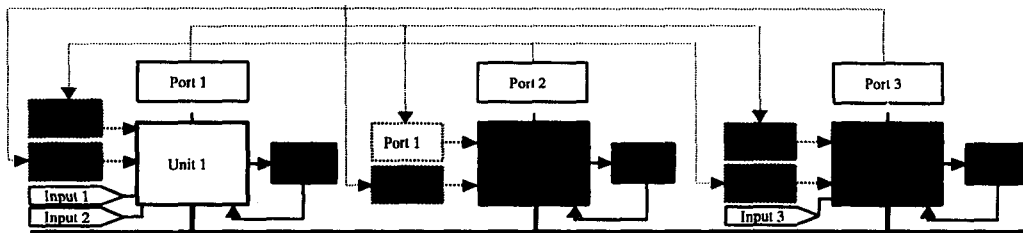

Figure 3 TCN interfaced control system

The dashed line is not a physical connection but a logical connection. The inputs are not physically connected to all units. The inputs are connected to the nearest units; The inputs 1 and 2 are to unit 1 and the input 3 is only to unit3. The other units which request a remote input signal are fed through network line with ports. In other words each input and output signal is physically connected to just one unit. The implementation is very simple and economical. But it performs the same control functions of shown in figure 2.

3. 3 Design concept of KHST on-board computer system

The KHST on-board computer system is designed as a network interfaced distributed processing system. The distributed units are divided by functions. The diagnosis and control algorithms are implemented by software program. The basic concepts are:

- Important diagnosis and control decisions are made by SCU which is in leading locomotive with redundant unit.
- Traction and braking control functions are performed by TCU and BCU which are independent of other units.

- The diagnosis and control of vehicle devices are performed by VCU.
- The network gateway of locomotive has redundancy.

The units of KHST-7 on-board computer system with network interface are listed in Table 2. The locomotives on-board system block diagram is illustrated in Figure 4.

Table 2. Units of network interfaced on-board computer system (KHST-7)

Name [Numbers on a KHST-7]	Functions	On-Boarded
SCU [4] (Supervisory Control Unit)	- Train diagnosis & control - Locomotive diagnosis & control - Desk to network interface - Display to network interface and control - Communication management between train and site	2 / Locomotive 1 : Active 1 : Hot Standby
VCU [5] (Vehicle Control Unit)	- Coach diagnosis & control - Door diagnosis & control	1 / Motor Coach 1 / Trailer Coach
ATC/ATS [4] (Automatic Train Control/Automatic Train Stop)	- Signal interface between rail and train - Display control - SCU display backup	2 / Locomotive 2 : Dual Active
TCU [6] (Traction Control Unit)	- Motor block diagnosis and control - Anti slip control - Electric brake diagnosis and control	2 / Locomotive 1 / Motor Coach
BBCU [2] (Brake Blending Control Unit)	- Total brake blending control	1 / Locomotive
BCU [10] (Brake Control Unit)	- Mechanical brake diagnosis and control - Anti slide control	2 / Locomotive 2 / Motor Coach 1 / Trailer Coach #3 & #5
ECCU [4] (Eddy Current brake Control Unit)	- Eddy current brake diagnosis and control	1 / Motor Coach 1 / Trailer Coach #3 & #5
AUX [6] (AUXiliary block control unit)	- Auxiliary block diagnosis and control - Battery & Charger diagnosis and control	2 / Locomotive 1 / Motor Coach
AIRCON [7] (AIR-CONDITIONING control unit)	- Air-conditioner diagnosis and control - Pressure control	1 / Each Vehicle
G/W [9] (Gateway)	- Gateway between train bus and vehicle bus - Auto configuration of train set - Train bus communication control	2 / Locomotive 1 : Active 1 : Cold Standby 1 / Coach

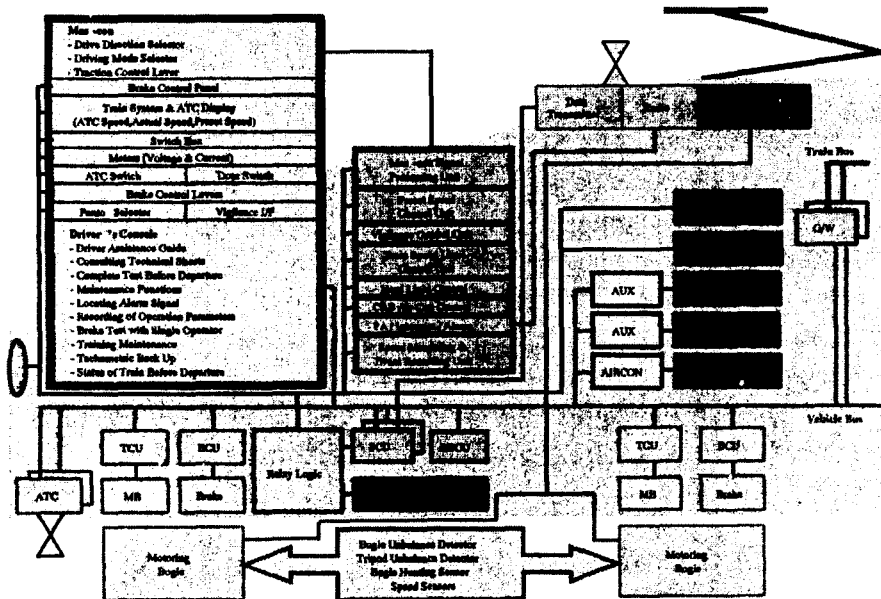

Figure. 4 On-board system block diagram of KHST locomotive

4. KHST on-board computer system network interfaces

The performance and functions of a train rely on its network system because the diagnosis information and the control data are transmitted through the network. This makes the selection of network system for distributed train on-board computer system very important.

For guaranteeing the compatibility and the performance of on-board computer system, TCN (Train Communication Network) is realized as the form of UIC-556 and IEC 615375.

TCN is designed as the most suitable specifications for train system because of:

- Duplex structure for high reliability
- Short data transmission period for real time processing
- Sufficient transmission distance for full train set
- Efficient access control
- Automatic train configuration
- Ready for modular system
- Communication compatibility
- Chipper and lighter than hardwired logic

For communication and algorithm test of KHST the on-board computer system listed in Table 2 is realized with TCN.

Locomotive on-board computer system of KHST is illustrated in Figure 5. TCN interfaced units are:

- Doubled SCUs for train set system control
- Two TCUs for traction and electric braking control
- Two BCUs for mechanical braking control
- Two AUXs for auxiliary block diagnosis and control
- Redundant gateways as node between train WTB (Wire Train Bus) and MVB (Multifunction Vehicle Bus)
- An I/O unit for drivers desk interface to MVB
- A PLC that simulates ATC/ATS
- A display unit for drivers interface

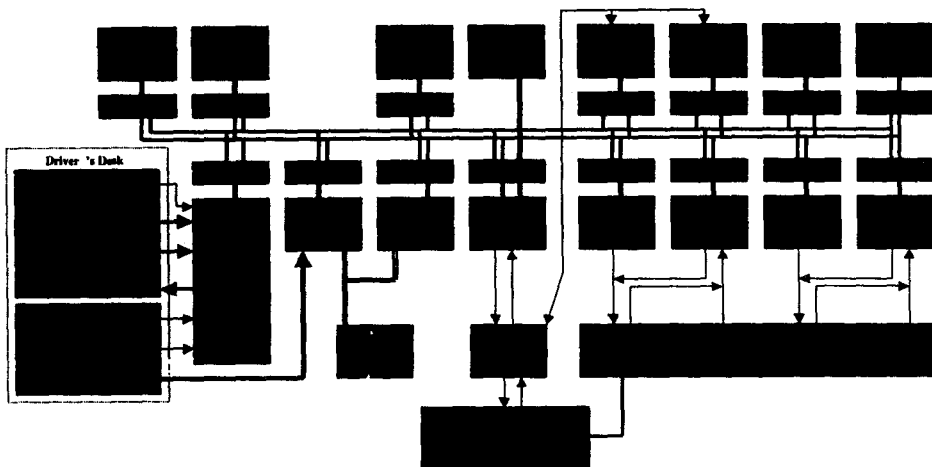

Figure 5 KHST locomotives on-board computer system for test

It can be seen in figure 5 that the connection is very simple. All network transferred information of not only within locomotive but also between full train set is monitored on display units.

Figure 6 shows the system diagram of motor coach, which is basically the same as the one shown in figure 5. The difference is that the motor coach has a VCU for vehicle diagnosis and control.

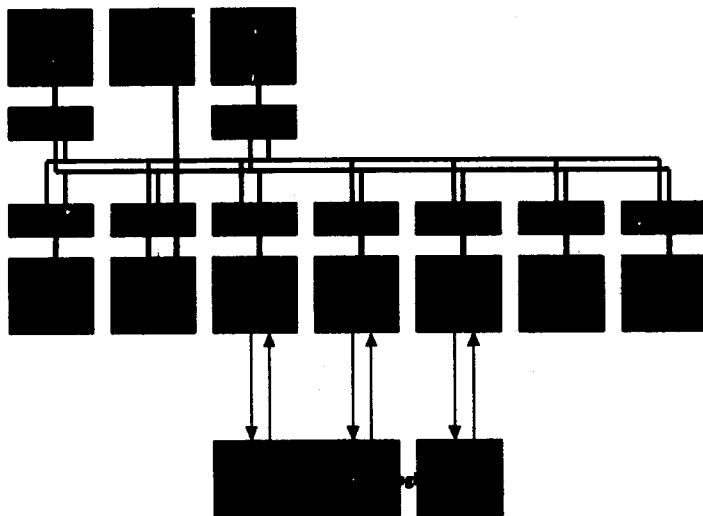

Figure 6 KHST motor coaches on-board computer system for test

Trailer coach #3 and #5s system is illustrated in figure 7. It does not have TCU, AUX and BCU for motor block because the motor block and auxiliary block are not installed in trailer coach. Trailer coach #4 has the same structure except BCU because it does not have bogies.

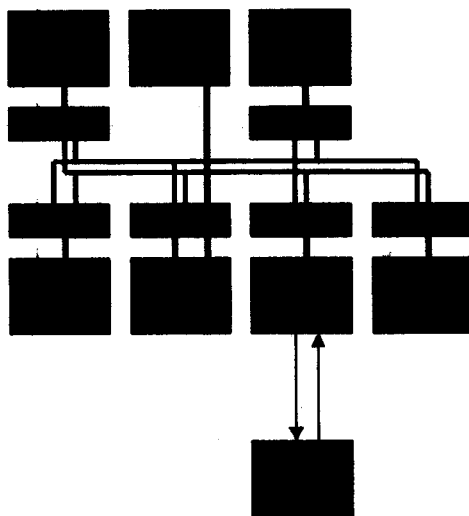

Figure 7 KHST trailer coach #3 and #5s on-board computer system for test

5 Conclusion and Future work

On-board computer system draft design is presented with the concepts of:

- (1) Distributed diagnosis and control
- (2) TCN based communication through full train set

Test system is realized and communication and algorithm test is successfully performed.

KHST will test run in the future with on-board computer system based on a final design. The draft design is not a fully TCN interfaced system. The next version of KHST on-board computer system will more widely adapt the TCN.

Acknowledgement

This research work is a part of the KHST development project n.2-7-0 funded by the Ministry of Construction and Transportation(MOCT), the Ministry of Commerce, Industry and Energy(MOCIE) and the Ministry of Science and Technology(MOST).

References

1. IEC, IEC-61375-1: Electric Railway Equipment Train Bus, 1st Edition, 1999
2. UIC, UIC Leaflet 556: Information Transmission in the Train (Train Bus), 2nd Edition, 1999