

Development of Multi Forming Product Progressive Die for STS 304 Marine Part Sheet Metal (Part 2)

Sung-Bo Sim*, Yul-Min Sung**, Young-Seok Song***

* Pukyong National Univ. School of Mech. Eng.

** Pukyong National Univ. Industrial Graduate School

*** Pukyong National Univ. Graduate School

Key Words : Die making, Tryout, Tolerance, Assembling function, components drawing, Revision

Abstract : Ultra precision progressive die have used for above one million's lot size of production part.

In the field of design and making tool for press working, the progressive die for sheet metal (STS 304, thickness :0.5mm) is a specific division. In order to prevent the defects, the optimum design of the production part, strip layout, die design, die making and tryout etc. are necessary. They require analysis of many kinds of important factors, i.e. theory and practice of metal press working and its phenomena, die structure, machining condition for die making, die materials, heat treatment of die component, know-how and so on. In this study, we designed and constructed a progressive die of multi-stage and performed try out. Out of these processes the die development could be taken for advance. Especially the result of tryout and its analysis become the characteristics of this paper (part 1 and part 2) that nothing might be ever seen before such as this type of research method on all the processes. In the part 2 of this study we treated die making and tryout mostly.

1. Introduction

The design may include components or devices to position, locate or guide the sheet metal strip. Idle stages, at which no works performed, are used spread out, closely spaced or to better distribute the forces regarded to perform the work.

The progressive die with multi-stage performs a series of sheet metal working at two or more stages during each press stroke to produce a piece part as the strip stock moves through the die. Press working for the optimum die design and its making has been become the purpose of industry by strip process layout with multi-stages. We used the part of ordinary product in industrial production line or society of our general living field as this paper subject.

So, this study needs a whole of press tool data, our field experiences, and theoretical references. According to upper instruction this study could approach to the optimum die design and making. Furthermore the aim of zero defects could be obtained mostly by revision on the try out.^{1,2)}

2. Die Making

2.1 Die Assembling Drawing and Its Components Drawing

Fig.1 shows the die assembling by front view from part 1 of this study. At the same time, we worked die components drawing as a Fig.2, but too many components were in this progressive die, so we selected punches and die inserts as a limitation of components.

The other components will be studied next part 3 and part 4 of this study.

About die inserts treating, Ferrotic steel was used by its maker's suppling by orders, and then die inserts machining was performed by mirror machine tool and hand finishing finally. Especially, die insert's radius shoulders were finished as a mirror surface by too many times hand polishing.

2.2 Die Making System

Fig.3 shows the progress of CNC machining center working. Fig.4 shows the press die working system. Fitting tolerances are very careful factors for die making because whole die setting method must be within fine central

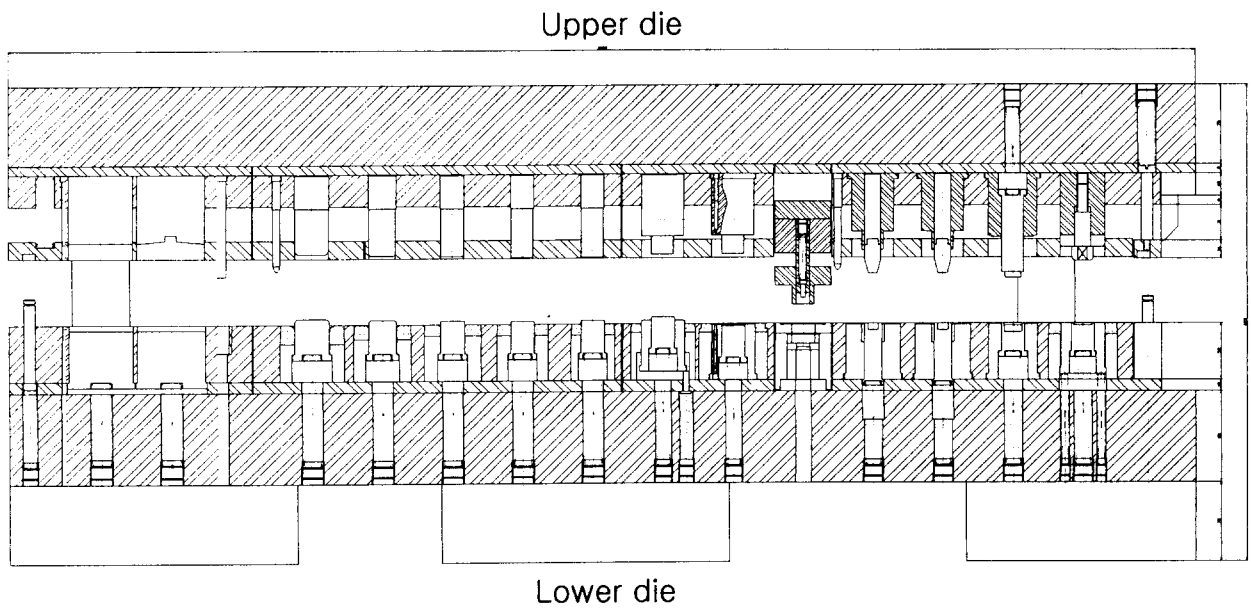
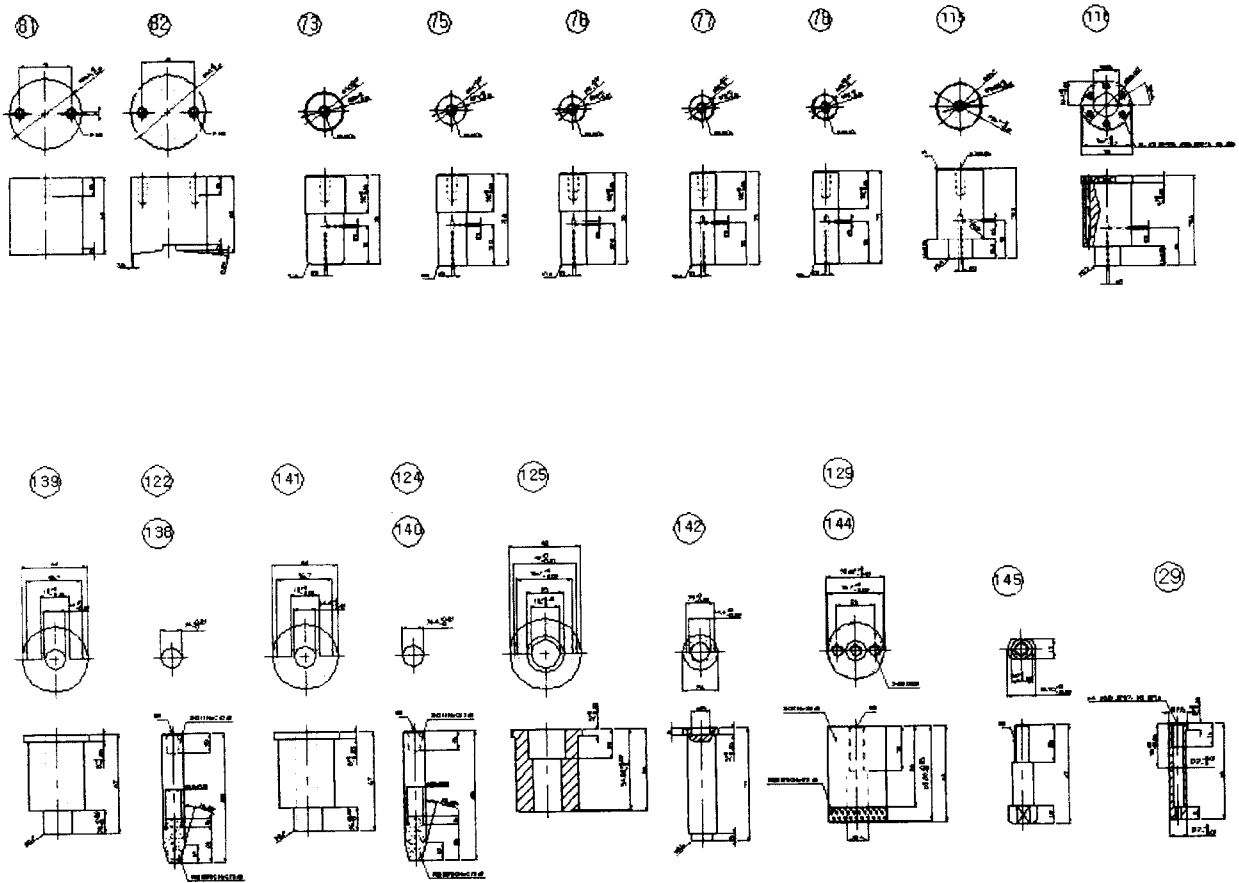

Fig.1 Die assembling drawing



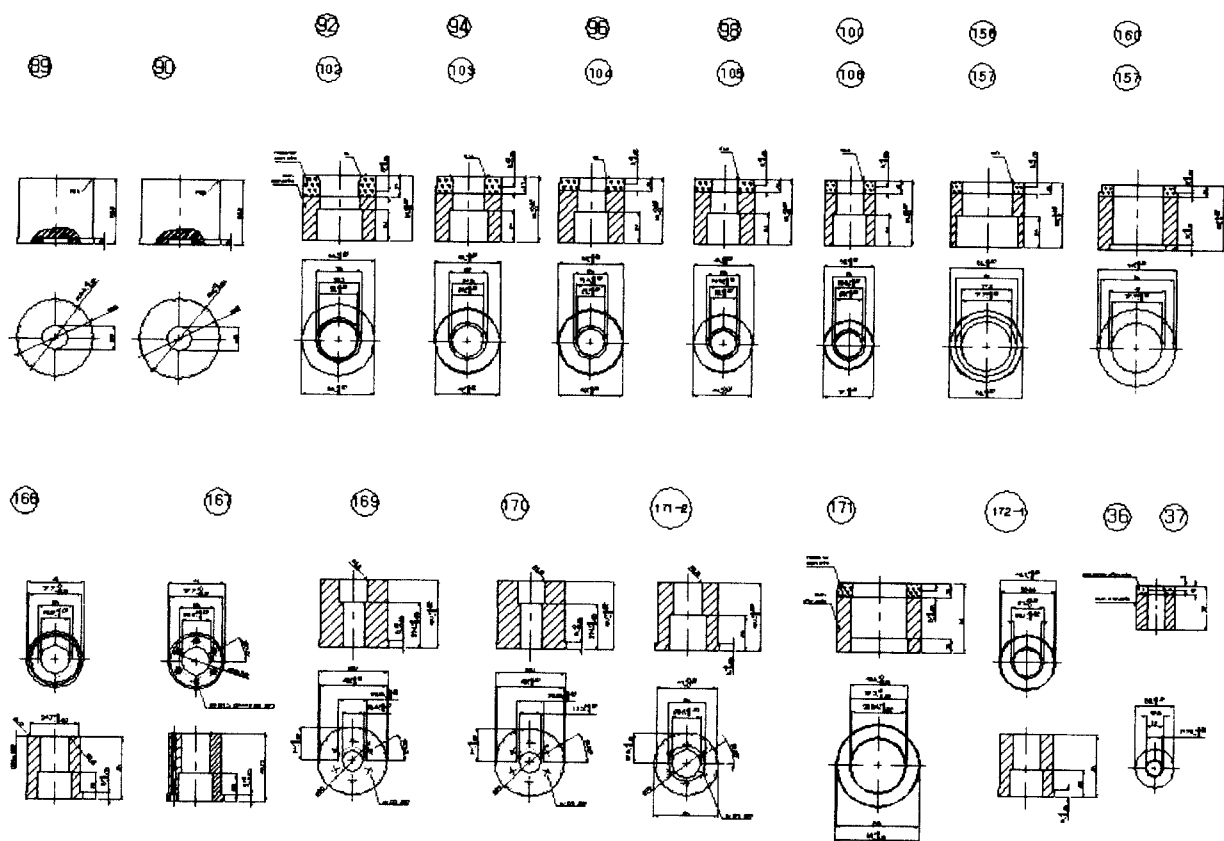

Fig.2 Die component drawing (punch and die insert part)

Table 1. Material List

No	Description	Material	Size	MEMO	QTY	No	Description	Material	Size	MEMO	QTY
28	Backing Plate	SK3	49*110*16	HRC58 ± 2	1	105	Drawing Die	Ferrotic		HRC72 ± 2	1
29	Piercing Punch	SKD11	∅12.5*64	HRC62 ± 2	1	106	Drawing Die	Ferrotic		HRC72 ± 2	1
36	D.P. Insert	Ferrotic		HRC72 ± 2	1	111	Upper Backing Plate	SK3	320*180*8	HRC58 ± 2	1
37	D.P. Insert	SKS3		HRC60 ± 2	1	112	Punch	Plate	320*180*28		1
40	Stripper Plate	SKS3	49*180*33	HRC60 ± 2	1	113	Die Plate	SKD11	320*180*50	HRC62 ± 2	1
58	Die Plate	SKD11	131.5*180*50	HRC62 ± 2	1	114	Lower Backing Plate	SK3	320*180*10	HRC58 ± 2	1
59	Lower Backing Plate	SK3	131.5*180*10	HRC58 ± 2	1	115	Drawing Punch	SKD11	∅36.8*70.5	HRC62 ± 2	1
60	Die Plate	SKD11	262*180*50	HRC62 ± 2	1	118	Punch	SKD11	∅39*70.5	HRC62 ± 2	1
60-1	Lower Backing Plate	SK3	286*180*10	HRC58 ± 2	1	121	Upper Backing Plate	SK3	316.5*180*8	HRC58 ± 2	1
60-2	Die Plate	SKD11	25*180*50	HRC62 ± 2	1	125	P.P. Insert	SKD11	∅48*55	HRC62 ± 2	1
63	Upper Backing Plate	SK3	211*180*8	HRC58 ± 2	1	128	Punch	SKS3		HRC70 ± 2	1
64	Punch Plate	SKS3	211*180*28		1	133	Upper Backing Plate	SK3	131.5*180*8	HRC58 ± 2	1
66	Stripper Plate	SKS3	211*180*20	HRC60 ± 2	1	134	Punch Plate	SKS3	131.5*180*28		1
67	Die Plate	SKD11	211*180*50	HRC62 ± 2	1	136	Stripper Plate	SKS3	131.5*180*16	HRC60 ± 2	1
68	Lower Backing Plate	SK3	211*180*10	HRC58 ± 2	1	137	Stripper Plate	SKS3	262*180*16	HRC60 ± 2	1
73	Drawing Punch	SKH9		HRC61	1	138	P.P. Insert	SKS3	∅44*67	HRC60 ± 2	1
75	Drawing Punch	SKH9		HRC61	1	139	Punch	Ferrotic		HRC72 ± 2	1
76	Drawing Punch	SKH9		HRC61	1	140	P.P. Insert	Ferrotic	∅44*67	HRC60 ± 2	1
77	Drawing Punch	SKH9		HRC61	1	141	Punch	SKD11		HRC62 ± 2	1
78	Drawing Punch	SKH9		HRC61	1	142	Punch	SKD11	∅24*77	HRC62 ± 2	1
81	Circular Lancing Punch	SKD11	∅55.5*60	HRC62 ± 2	1	144	Punch	Ferrotic		HRC72 ± 2	1
82	Circular Lancing Punch	SKD11	∅59*60	HRC62 ± 2	1	145	Punch	SKD11	∅18.95*67	HRC62 ± 2	1
84	Stripper Plate	SKS3	222.5*180*16	HRC60 ± 2	1	156	Punch Plate	SKS3	286*180*28		1
84-1	Stripper Plate	SKS3	96.5*180*16	HRC60 ± 2	1	157	D.P. Insert	SKD11	∅61*50	HRC62 ± 2	1
85	Stripper Plate	SKS3	49*250*30	HRC60 ± 2	1	158	Drawing Die	Ferrotic		HRC72 ± 2	1
92	Drawing Die	Ferrotic		HRC72 ± 2	1	158-1	Drawing Die	SKS3		HRC60 ± 2	1
94	Drawing Die	Ferrotic		HRC72 ± 2	1	165	D.P. Insert	Ferrotic		HRC72 ± 2	1
96	Drawing Die	Ferrotic		HRC72 ± 2	1	166	D.P. Insert	SKD11	∅41*45	HRC62 ± 2	1
98	Drawing Die	Ferrotic		HRC72 ± 2	1	167	D.P. Insert	SKD11	∅41*49.13	HRC62 ± 2	1
100	Drawing Die	Ferrotic		HRC72 ± 2	1	169	D.P. Insert	SKD11	∅51*49.1	HRC62 ± 2	1
102	Drawing Die	Ferrotic		HRC72 ± 2	1	170	D.P. Insert	SKD11	∅51*49.1	HRC62 ± 2	1
103	Drawing Die	Ferrotic		HRC72 ± 2	1	171	D.P. Insert	SKD11	∅46*50	HRC62 ± 2	1
104	Drawing Die	Ferrotic		HRC72 ± 2	1	172	D.P. Insert	SKD11		HRC62 ± 2	1

punch and die activities for the symmetrical equalized to the left and right side each other. In this study, we used ordinary machine tools, CNC machine tools and EDM, etc. On the accuracy of each fitting component, tolerances, the first is guide bush and guide post(outer or inner) tolerances are H7(hole) h6(shaft) and the die set and guide post tolerances are H7(hole) p5(shaft) for a tight fitting. Punch plate and punch tolerances are H7(hole) m6(shaft) for a tight fitting with minor interference. The second is stripper and the punch tolerance is H7(hole) h6(shaft), too. Die inserting hole and die insert button are H7(hole).^{6,7)}

Fig.5 shows the wear amount of die materials.

In this figure we can select the adaptive die block material STD11 and die inserts material Ferrotic according to the punch and die characteristics in the case of use. Punch and die block is main part in die making. In this study, we decided the size of punch and die block depending on data base, theoretical background and our own field experiences.

The machining of punch and die block can belong to the precision machine tool working, continually raw material cutting, milling, turning, drilling, shaping, profiling, and then heat treating, electronic discharge machining (EDM, Wire-Cut), jig grinding, especially, CNC machining and mirror machine tool.³⁻⁵⁾

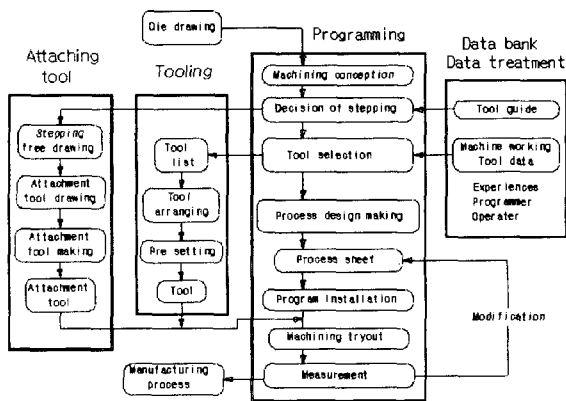

Fig.3 Progress of CNC machining center working

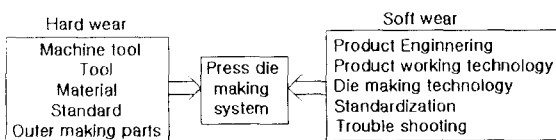

Fig.4 Press die making system

3. Tryout Result

Fig.7 shows the actual strip process result from tryout working. In this actual process strip, we could confirm the real process for making the production part. Also we checked every size of production part with tolerance control.

We could find the jamming problem such as the material strip through the guide tunnel on the die block surface. Also, when the material strip passes through the tunnel, the roll feeding device operation must be checked very exactly. The trouble shooting of this problem comes from die setting skill and technology. Furthermore, the production part from tryout was very fine by inspection, too.

At this time, the check of die failures was performed through the production part and actual strip of every stage with punch and die edge by the survey and fine instruments. We considered that all of the failures cause are associated those stresses present in the die, those are generated during either its manufacturing, its service life or both.

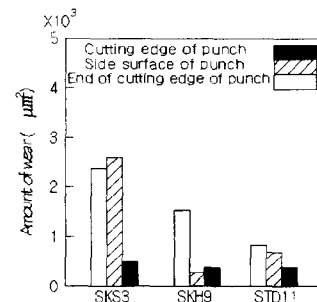

(a) Effect of tool steels by punch wear

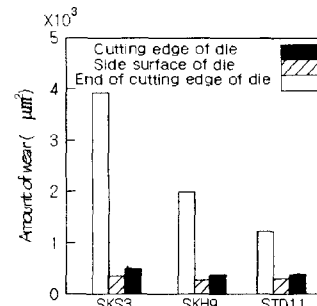

(b) Effect of tool steels by die wear

φ 10 blanking, H_RC61(punch, die)
baintesteel, 10% clearance-lubrication

lot size : 10,000

Fig.5 Comparative materials of punch and die



(a) Machining center(A) and cylindrical grinding machine(B)

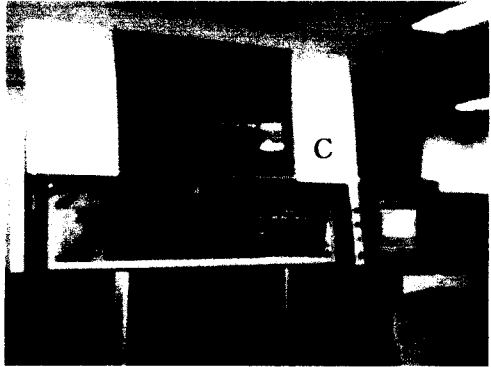

(b) Rapid profile laser machine (C)

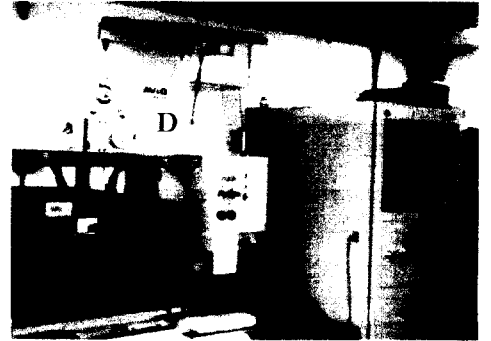

(c) Wire electric discharge machine (D)

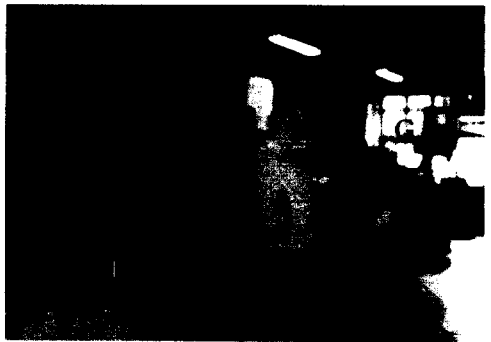

(d) Wire cut(E), turning m/c(F) and power drilling m/c(G)

Fig.6 Die making machine tools

← Feed Direction



(a) 4~14 stage of strip process layout modeling



(b) 4~7 stage of strip process layout modeling



(c) 7~10 stage of strip process layout modeling



(d) 10~13 stage of strip process layout modeling

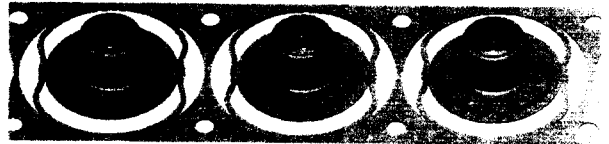

(e) 12~14 stage of strip process layout modeling

Fig.7(a) Result of strip process layout modeling by I-DEAS

← Feed Direction



(a) 4~14 stage of actual strip process layout



(b) 4~7 stage of actual strip process layout



(c) 7~10 stage of actual strip process layout

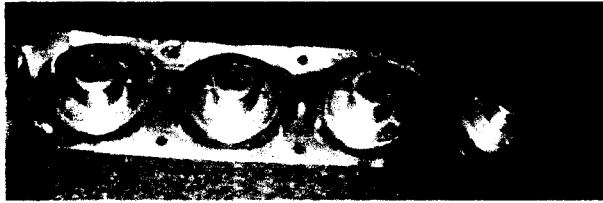

(d) 10~13 stage of actual strip process layout



(e) 12~14 stage of actual strip process layout

Fig.7(b) Result of real strip process layout by tryout

Fig.8 shows the result of tryout namely real production part. In this result, we considered that the shape and size with tolerance were satisfied.

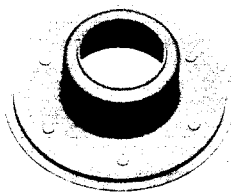

Fig.8(a) Result of production part modeling by I-DEAS

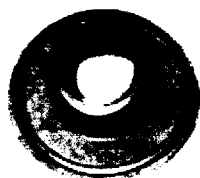

Fig.8(b) Produced part strip by tryout

4. Conclusion

In order to prevent the defect of die design and making, this study developed the practical and adaptive die assembling and its components.

This study could be carried out actual die making by the theoretical back ground, data base and our field experiences.

The result are as follows;

- (1) By the part 1 of this study, ultra precision progressive die could be made successfully.
- (2) The result of die making and its tryout was performed with screw press by all need equipments of very skilled technology.
- (3) The split die making system was effective for die assembling function and trouble shooting.
- (4) For the continuous die assembling function's increasing, the revision of die components were necessary with die components accuracy on tryout progress.

References

- (1) Sim, Sung-Bo, Park, Sun-Kyu, Development of the Practical and Adaptive Die for Sheet Metal(1), Proceedings of KCORE Conference, pp. 141~148, May, 1999.
- (2) Sim, Sung-Bo, Song, Young-Seok, Development of the Practical and Adaptive Die for Sheet Metals(2), Proceedings of KCORE Conference, pp. 149~155, May, 1999.
- (3) Karl, A. Keys, Innovations in Die Design, SME, pp. 71~99, 1982.
- (4) Hashimoto, M., Preworking and Die Making. Higan Tech. Paper Co., pp. 121~180, 1975.
- (5) Hutota. T, Databook of Pressworking Process Design, Press Tech., Vol. 7 No. 13, Higan Tech. Paper Co., pp. 1~120, 1969.
- (6) Donald, F. Eary, Edward, A. Reed, Techniques of Pressworking Sheet Metal, Prentice Hall, Inc, pp. 37~93, 1974.
- (7) Serope, Kalpakjian, Tool abd Die Failures, ASM, pp. 18~31, 1982.